

SIEMENS

7XV5655-0BA00

Manual

C53000-G1176-C174-4

Application Instructions

Serial Hub

Ethernet hub for transmission of serial data or protocols from devices with an RS232, RS485 or FO interface via Ethernet



CONTENTS

General Information	3
Application	8
Description of Interfaces, DIP Switches and Displays	11
Mounting and Commissioning.....	14
Mounting and Commissioning.....	15
Practical Safety Information	18
Preparing the Operating PC or Service Notebook	19
The Configuration Tool	26
Optimising Data Transfer.....	39
Selecting a Password-Protected Serial Hub	40
Pin Assignment.....	42
Technical Data.....	45
Dimensions	50
Ordering Information	51

General Information

This manual contains the information that is necessary for proper and safe operation of the products described. This manual is intended for technically qualified personnel having received special training in, or having special knowledge of protection, measurement and control engineering, hereinafter called automation engineering. The knowledge and correct application of the warnings and instructions contained in this manual are prerequisites to safe installation and commissioning of this product, as well as to proper and safe operation and maintenance. Only qualified personnel as defined overleaf have the special knowledge required for correct interpretation of the general safety information and warnings given in this manual, and for their application to the task in hand. This manual is included in the scope of delivery. For reasons of clarity, however, it does not purport to contain every detail of all versions of the product described, nor can it deal with all possible cases of erection, operation or maintenance. If further information is desired or if special problems arise that are not treated adequately in this document, it is possible to obtain additional details from your local Siemens office or from the addresses stated on the back of this manual.

We should also like to point out that the contents of this product documentation are not part of any previous or existing agreement or legal relationship, nor are they apt to modify such an agreement or relationship. All obligations incurred by Siemens result from the purchase contract, which also contains the complete and solely applicable warranty conditions. Contractual warranty conditions are neither extended nor restricted by the contents of this document.

Disclaimer of Liability

We have checked the contents of this document and every effort has been made to ensure that the descriptions of both the hardware and software are as accurate as possible. However, since deviations cannot be ruled out entirely, we do not accept liability for complete conformity or for any errors or omissions.

The information given in this document is reviewed regularly and any necessary corrections will be included in subsequent editions. We are grateful for any improvements that you care to suggest.

Subject to technical modifications without notice.

Release 4.00.00

Copyright

Copyright © Siemens AG 2012. All rights reserved.

The reproduction, transmission or use of this document or its contents is not permitted without express written authority.

Offenders will be liable for damages. All rights, including rights created by patent grant or registration of a utility model or design, are reserved.

Registered Trademarks

SIPROTEC, SINAUT, SICAM and DIGSI® are registered trademarks of Siemens AG. Other designations in this manual might be trademarks whose use by third parties for their own purposes would infringe the rights of the owner.



Statement of Conformity

This product complies with the directive of the Council of the European Communities in accordance with the laws of the member states relating to electromagnetic compatibility (EMC Council Directive 2004/108/EC) and concerning electrical equipment for use within specified voltage limits (Low Voltage Directive 2006/95/EC).

This conformity has been proven by tests performed according to the Council Directives in agreement with the generic standards EN 61000-6-2 and EN 61000-6-4 (for EMC Directive) and with the standard EN 60255-6 (for Low Voltage Directive) by Siemens AG.

The device is designed and manufactured for application in industrial environments. The product conforms to the international standards of IEC 60255 and the German regulations of VDE 0435.

Instructions and Warnings

The information and warnings in this manual must be observed for your safety and to ensure an appropriate service life of the device.

The following terms and definitions are used:



DANGER

means that death, severe bodily injury or substantial material damage will occur if the appropriate precautions are not taken.



Warning

means that death, severe bodily injury or substantial material damage could occur if the appropriate precautions are not taken.



Caution

indicates that minor bodily injury or material damage could result if appropriate precautions are not taken. This applies in particular to damage on or in the device itself and resulting consequential damage.



Note

contains important information about the product or a part of the document to which special attention is directed.



Warning

The 7XV5655-0BA00 is specifically intended for installation in a switchgear cubicle or distribution box. After installation, the entire area around the terminals must be appropriately covered. Only then is the device sufficiently protected against improper contact with live parts.



Warning!

Hazardous voltages occur in this electrical equipment during operation. Severe personal injury or property damage can result if the device is not handled with the appropriate care.

Only qualified personnel should work on or around this equipment. The personnel must be thoroughly familiar with all warnings and maintenance procedures contained in this manual, as well as the appropriate safety regulations.

Successful and safe operation of the unit depends on proper transportation, storage, mounting and assembly as well as the observance of the warnings and instructions contained in this manual.

In particular, the general installation and safety regulations for work in power current plants (e.g. ANSI, IEC, EN, DIN, or other national and international regulations) must be observed.

Failure to observe these precautions can result in death, personal injury, or serious material damage.

Never look into fibre-optic components or the ends of the fibres.



Qualified Personnel

For the purposes of this manual, the warnings on the product itself, only persons who are acquainted with the mounting, installation, commissioning and operation of the device and who possess the appropriate qualifications for their task, such as

- training and instruction to energise, de-energise, clear, earth and tag circuits and equipment in accordance with established safety practice,
 - training or instruction in accordance with established safety practice for care and use of certain safety equipment,
 - training in rendering first aid can be considered as qualified personnel
-

Scope of Supply

- Serial Hub for DIN rail mounting
- Gender changer, 9-way, male-male
- CD with manual and configuration tool
- Installation Instructions

Unpacking and Repacking

The devices are factory-packed to meet the requirements of IEC 60255–21.

Unpacking and re-packing must be performed with the required care, without force and only with the aid of suitable tools. Visually check the device immediately upon arrival for correct mechanical condition.

Please also always follow instructions if they are supplied with the device.

The shipping packaging can be re-used in the same manner for further shipment.

Note that the storage packaging of individual devices is not sufficient for shipping. If other packaging is used, the shock requirements acc. to IEC 60255–21–1 Class II and IEC 60255–21–2 Class 1 must be met.

The device should be stored in the final operating area for a minimum of two hours before the power source is first applied. This gives the device time to acclimatise to the temperature equilibrium, thus avoiding dampness and condensation.

Storage

SIPROTEC® devices and associated parts should be stored in a dry and clean place. The device as well as its replacement modules must be stored within the temperature range, which is –10 °C to +55 °C.

The relative humidity is not allowed to lead to condensation or ice.

To avoid premature ageing of the electrolyte capacitors in the power supply unit, a temperature range of +10 °C to +35 °C (+50 °F to +95 °F) is recommended for storage.

After extended storage, the power supply of the device should be energised, approximately every two years for one or two days, to regenerate the electrolytic capacitors in the power supply unit. This should also be done before the device is put into service.

Application

General scope of application

The Serial Hub is designed for operation in industrial areas and substations.

The Serial Hub enables devices with serial interfaces (RS232, RS485, or FO) to convert data to the UDP protocol and to transmit and receive data via a TCP/IP network. This enables devices without dedicated network ports to exchange data via Ethernet.

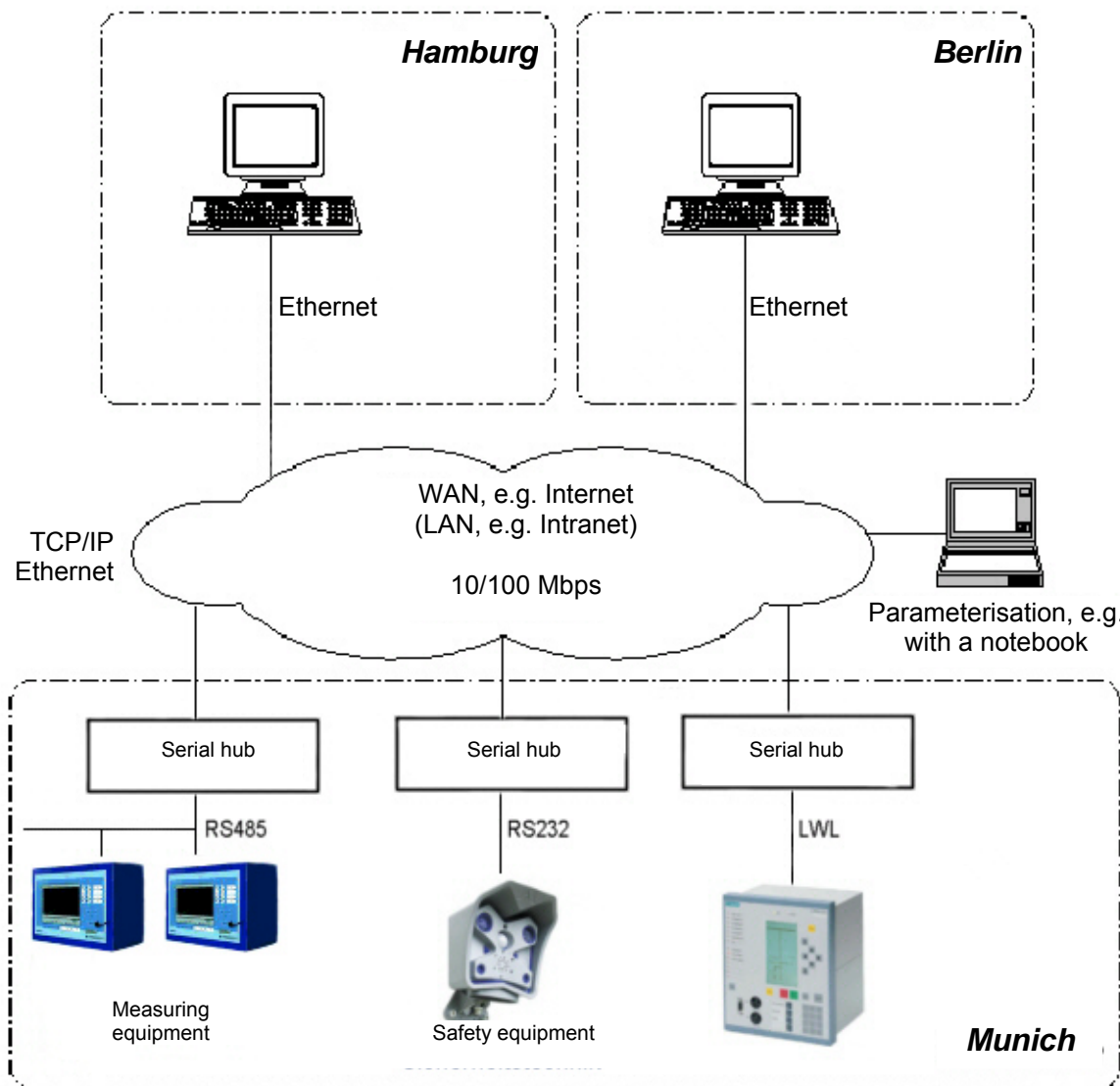

Fig. 1: General scope of application of the Serial Hub

Application in Substations

When using a 7XV5655-0BA00 Serial Hub with a fixed IP address, one or more SIPROTEC® protection units can exchange serial data via an Ethernet network. On the operating PC, a configuration tool is applied to link a virtual COM port with the IP address of a Serial Hub. The use of DIGSI 4 enables the operation of all protection units connected to the Serial Hub via the virtual COM port.

The protection unit is connected to the Serial Hub via its serial interface. The serial interface types available are RS232 or RS485 (same connector), and FO (fibre optic cable). The serial data is converted to the UDP protocol with error detection and correction in the Serial Hub and transmitted via the TCP/IP Ethernet network.

The hub meets the requirements for standard compliance, uninterrupted transmission of serial DIGSI® or IEC 60870-5-103/101 frames via the network by listening into the serial frame traffic and sending the serial IEC telegrams via the Ethernet, packed into blocks. Both full-duplex and half-duplex data transmission (RS485) is possible. Serial control lines are not supported. The Serial Hub can be configured with password protection. Configuration of the Serial Hub is performed using the configuration tool which is included in the scope of supply.

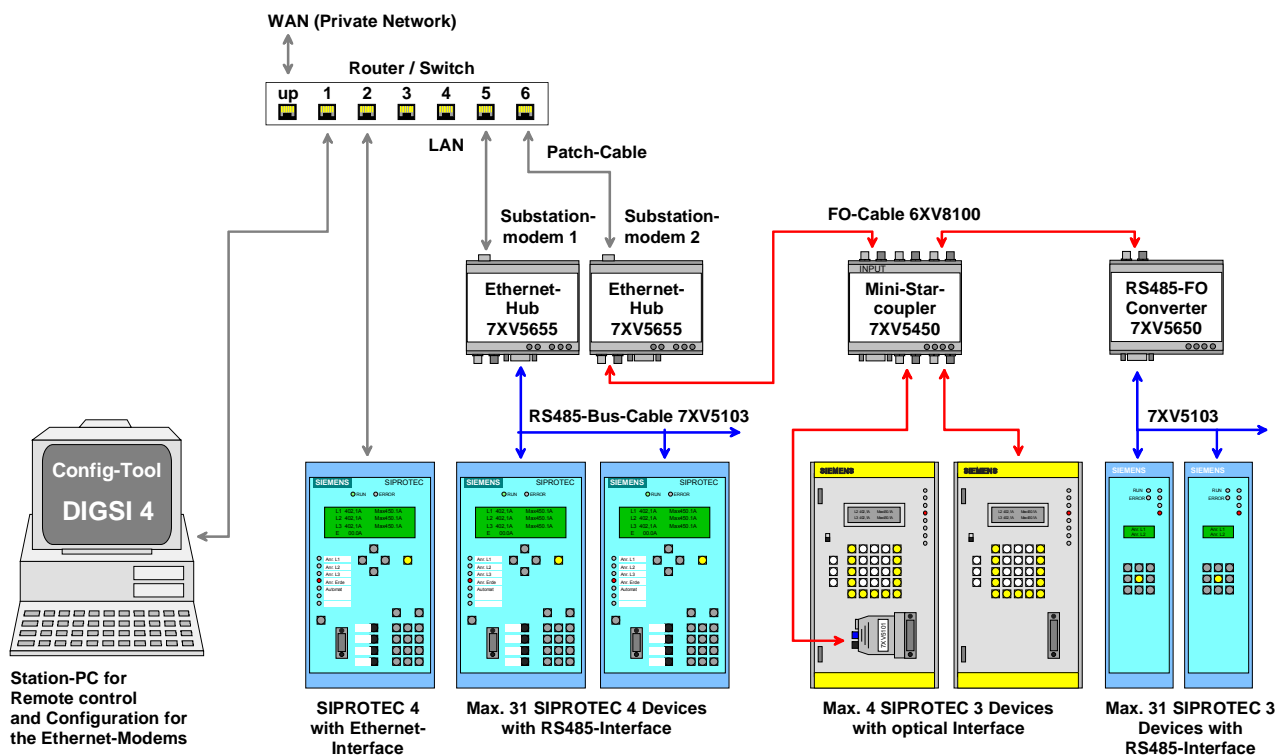

Fig. 2: Serial Hub, application in substations with SIPROTEC® devices

Features

- Protocol detection according to EN 60870-5-101/103 and DIGSI protocol (similar to IEC60870-5-103), UDP protocol with error detection and correction
- A 10-Mbit Ethernet interface (10BaseT) for the 10/100 Mbit network.
- RS232/RS485 (switchable port) or FO interface for data transfer.
- Serial baud-rate and data format to the terminal devices is automatically set by the application, e.g. DIGSI 4 at 2400 Bd to 57.6 kBd (115.2 kBd) with data formats 8N1, 8N2, 8E1.
- Re-set to default values (factory settings) with INIT button: 9600 baud, 8N1
- DIP switch for RS232/RS485 selection and RS485 bus termination as well as FO idle state
- Enhanced security is possible with password protection
- LED displays for operating voltage and data traffic are located on the front panel.
- DIN rail module in the plastic housing with integrated wide-range power supply unit (24 - 250 V DC and 60 - 230 V AC) which provides connection to all conventional substation batteries or AC power systems.
- Protective conductor (PE) connection
- Easy configuration with the configuration tool
- Configuration tool V15 for
 - Microsoft Windows® XP Prof. 32-Bit SP3
 - Microsoft Windows® 7 Prof. 32-Bit SP1
 - Microsoft Windows® 7 Prof. 64-Bit SP1
 - Microsoft Windows® Server 2008 R2 / 64-Bit

Description of Interfaces, DIP Switches and Displays

The Serial Hub has the following connectors:

- A switchable RS232/RS485 interface (9-way SubD male connector)
- FO transmitter and receiver port with ST connectors
- 10-Mbit Ethernet connector (10BaseT) for a 10/100 Mbit network
- DIP switches for RS232/RS485 switchover and RS485 termination as well as setting of the FO idle state
- AC/DC power supply and protective conductor (PE) connection via 3-way screw terminals

Communications Interfaces

The RS232/RS485 or FO interfaces are controlled internally by the same processor interface. The electrical interface is selected via the DIP switches. A choice exists between RS232 or RS485; the FO interface always operates in parallel with RS232 or RS485 at the transmitter end and is OR'ed with RS232/485 at the receiver end, that is, both streams of receive data are unlocked and are received and checked with equal priority. To rule out data collisions, the connected protection units are addressed selectively by DIGSI®. This is done via the interface address of the protection units.

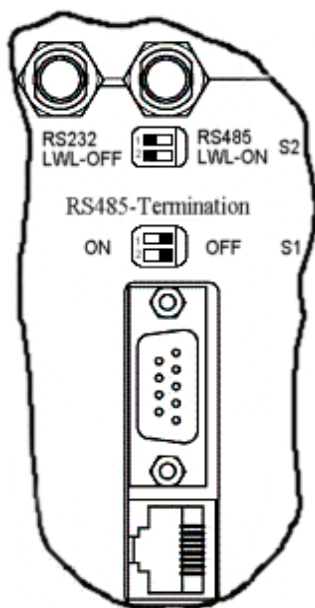

RS232 Interface

The terminal device (protection unit) (e.g. a SIPROTEC® 4 unit) or a device from the SIEMENS accessory program (e.g. a 7XV5300 or 7XV5450 star coupler for operating two or more SIPROTEC® devices) can be connected directly to the RS232 port. The data is exchanged between the protection unit and the Serial Hub via this interface.

To operate the RS232 interface, DIP switch S2-1 must be set to RS232 and DIP switches S1-1+2 to (RS485 termination) OFF. The DIP switch for the FO idle state (S2-2) must be OFF (see Fig. 3).

Fig. 3: Connectors and DIP switch positions
RS232

Note: The factory settings for all interfaces are 9600 baud / data format 8N1. The settings are automatically adapted to the terminal device's interface by the application (e.g. DIGSI) on connection.

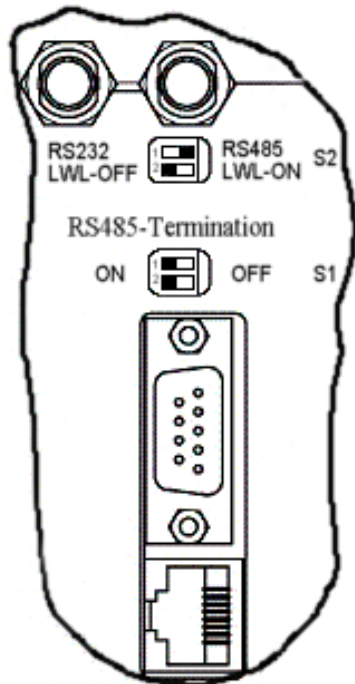

Fig. 4: Connectors and DIP switch positions RS485

RS485 Interface

The bus-capable RS485 interface provides a link with increased noise immunity than the RS232 interface. The data transfer rate is identical for both interfaces. The terminal device (e.g. SIPROTEC® 4 device) which is to be applied, or up to 30 further bus-capable SIPROTEC® devices can be connected directly to the RS485 port.

To apply the RS485 interface, DIP switch S2-1 must be set to RS485. The position of DIP switches S1-1+2 is dependent on the requirement of a RS485 termination (the termination is set to ON as the first or last device on the RS485 bus).

The DIP switch for the FO idle state (S2-2) must be OFF for idle state = OFF (see Fig. 4). For the RS485 mode, "half-duplex" mode it must be set using the configuration tool (see p. 36 RS232 Interface Settings)!

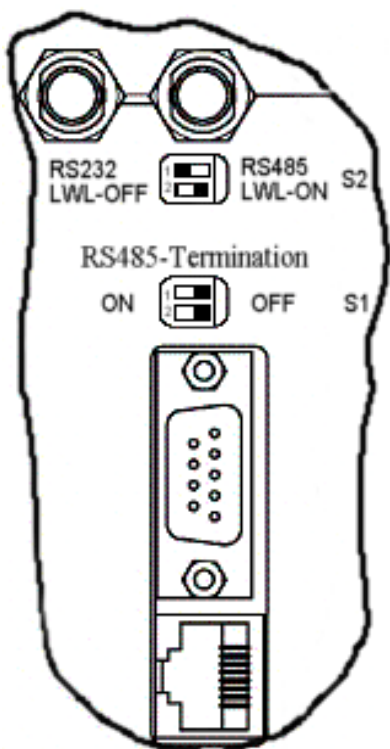

Fig. 5: Connectors and DIP switch positions FO

FO Interface

The FO interface has a transmitter and receiver port with an ST connector. It is a noise-immune link and is used whenever especially high interference levels are to be expected in the operating environment, or when equipotential bonding with the terminal device must be avoided. The data transfer rate is that of the RS232 interface. The terminal device (e.g. a SIPROTEC® 4 unit) or a further device from the Siemens accessory program (e.g. 7XV5300 or 7XV5450 star coupler for operating two or more SIPROTEC® devices) can be connected directly to the FO port.

Note: The FO interface is always active with the RS232 interface; the DIP switch (FO-OFF/FO-ON) only sets the idle state.

To use the FO interface, DIP switch S2-2 must be set to match the FO idle state of the communications partner (ON or OFF). DIP switch S2-1 for RS232/485 selection must be set to RS232. DIP switches S1-1 and S1-2 must be set to OFF (see Fig. 5). On SIPROTEC units, the idle state is pre-set to OFF. This is also the factory setting of the Serial Hub.

The 9-way RS232 interface can be used in parallel. If it is not, please cover it with the red protective cover included in the scope of supply !

If the FO interface is not used, it must also be covered with the protective covers included in the scope of supply.

Ethernet Interface (10BaseT)

The Ethernet interface 10BaseT (RJ45) is connected via an Ethernet patch cable (1:1, not cross-over) directly to the output of a router or switch. The data packed in the UDP protocol is transmitted to and received by the Ethernet via this interface. The Serial Hub can be configured using the configuration tool on a PC connected to this network via an ordinary patch cable.

By using the configuration tool on a PC with an Ethernet interface and a cross-over Ethernet patch cable connected directly to the Serial Hub, it is possible to configure the Serial Hub as well.

The configuration tool is included in the scope of supply.

Auxiliary voltage

The auxiliary voltage V_{aux} (AC/DC) and the protective earth conductor are connected via three terminals. The wide-range power supply unit has reverse polarity protection (terminals L+ and L- could be exchanged to AC and DC operation) and can for example be used in substations with substation batteries. It features double or reinforced insulation and backs up the auxiliary voltage for >50ms.

GOK Contact

The isolated GOK contact (device run) is for alarming faulty device states. The device internally monitors the supply voltage and proper functioning of the device.

The contact is open in the normal operating state and closes on faults and auxiliary voltage failure. It is connected via two terminals (GOK 1+2).

INIT button

The INIT button is for resetting the Serial Hub to its factory (default) settings and should only be operated by technically qualified personnel.

It can be used to set a defined baud-rate locally for service work. The default baud-rate is 9600 8N1. The Serial Hub also outputs a reset string with the date and version number of the firmware on its serial interface (RS232 / RS485 / FO).

This reset string can be read by a terminal program (e.g. HyperTerminal in Windows) on a connected PC. The serial interface of the PC must be set to the default baud-rate.

You do not need to use the INIT button if you know the baud-rate!

Operating the INIT button does not alter any settings relevant to security such as IP addresses or password!

Meaning of Displays

The LEDs indicate the state of the device and have the following meaning:

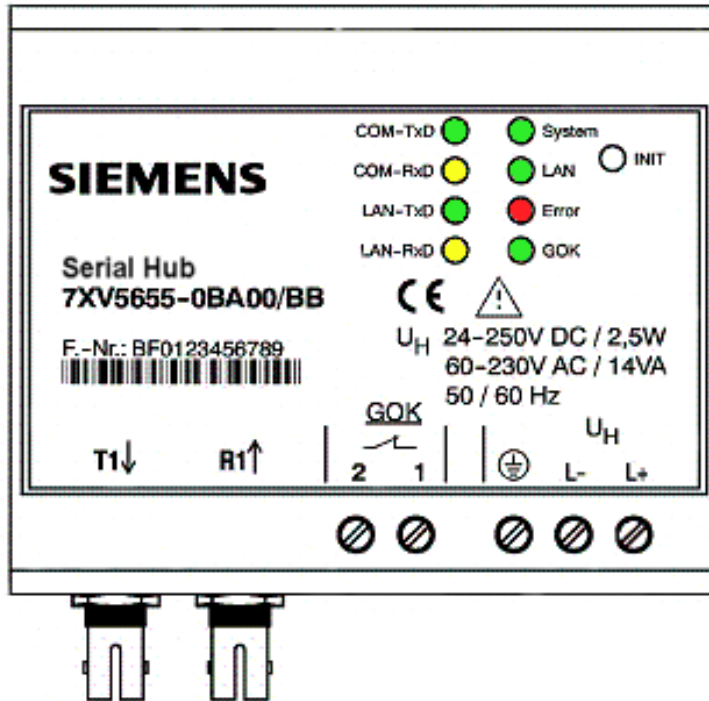

Fig. 6: Connectors, displays (LEDs) and INIT button

- **GOK** Device run: switched on, operating voltage OK (GOK) device operational
- **System** Slow flashing (approx. 1Hz): no connection to the terminal device
fast flashing (approx. 2Hz) : connection with the terminal device is running (CONNECT)
- **LAN** Physical connection with the network is operational
- **LAN RxD** Receiving data packets from the Ethernet
- **LAN TxD** Transmitting data packets to the Ethernet
- **COM RxD** Receiving data on the serial line from the terminal device (RS232/485 or FO)
- **COM TxD** Transmitting data on the serial line to the terminal device (RS232/485 or FO)
- **ERROR** Error on the serial line (RS232/485 or FO)

Mounting and Commissioning

This chapter is intended for experienced commissioning personnel. This personnel must be familiar with the commissioning of protection and control systems, with the management of power systems and with the relevant safety rules and standards. Hardware modifications that might have to be made in certain cases are explained. For primary testing, the connected protection unit must be switched on.

General



Warning of improper transport, storage, installation or mounting of the device

Failure to observe these precautions can result in death, personal injury, or serious material damage.

Problem-free and safe use of this device depends on proper transport, storage, installation and mounting of the device. All warnings and instructions in this manual must be taken into account.

In particular, the general installation and safety regulations for work with power current equipment (e.g. ANSI, IEC, EN, DIN, or other national and international regulations) must be observed.

Mounting Instructions

Devices for DIN rail mounting are only permitted for operation in enclosed housings or cubicles, and may only be mounted in locations that are accessible to qualified personnel only.

The DIN rail housing is intended for mounting on a symmetrical mounting rail according to EN 60715.

For mounting, the device is swung downwards onto the DIN rail, pressed downwards, and snapped on by pressing backwards. The connection is released by lifting the locking element on the underside of the device using a flat screwdriver to loosen it from the mounting rail. The device can then be lifted off the DIN rail in the opposite direction to the snap-on movement.

The data lines for electrical interfaces, e.g. RS232 or RS485, must be encased in screened, earthed cables.

The FO cables must comply with the connection standard of the device (technical data).

The mounting location should be as vibration-free as possible. The permissible ambient temperature (operating and functional temperature) must be observed (see Technical Data).

Operation outside the functional temperature range or in environments with increased air pollution can lead to malfunctions, failure, and destruction of the device (note the IP class of the device).

Connecting the Device

This describes the connection of all data and power supply lines that are necessary for safe operation.

In the case of electrical installation, follow the rules governing mounting of power current equipment.



Warning

Always use wire end ferrules for stranded conductors.



Warning

Never look into fibre-optic waveguide elements or the ends of the fibres.

Please observe the permissible bending radii of the optical fibre waveguide (manufacturer data).

Bending cables to a smaller radius than the minimum bending radius can destroy the FO fibres.

Auxiliary Power Connection

The contacts for the operating voltage are established via the terminals on top of the device. For the assignment of terminals please refer to the relevant sections of this manual.

The supply voltage of the device must be protected with an external disconnection device including a fuse, and identified as such. The fuse selected must be suitable for the cross-section of the connection wires or for the cubicle wiring. (For the fuse value, see the Technical Data.)

Screw terminal connection	Solid or stranded conductors with wire end ferrules for conductor cross-sections 0.25 mm ² to 2.5 mm ² The dielectric strength of the connecting wires must be at least 300 V AC. Stripping length: up to 8 mm
Minimum cross-section of the wires for auxiliary voltage and earth (ground)	1.5 mm ²
Nominal conductor cross-section	2.5 mm ² , rigid conductor or with wire end ferrule
Tightening torque	0.5 Nm

Connection to the Sub D connector

The Sub D connector must be fastened tightly after connection. The pin assignment is to be found in the relevant sections of this manual (page 41 ff).

Ethernet Connection

The Serial Hub is connected to the network, i.e. a router or switch, by using a patch cable, via the RJ45 (10BaseT) connector.

The dielectric strength of the Ethernet cable must be at least 300 V AC.

OR

The Serial Hub is connected directly to the LAN port of the operating PC using a cross-over patch cable via the RJ45 connector.

The "link LAN" LED indicates correct connection with the Ethernet.

If that is not the case, check the network connection or network cable.

Cat5 cables (or better) must be used.

Commissioning

Check whether the operating data match the values on the rating plate. Do not make any changes on the device that are not described in this manual.

Plug in the connecting cable for the RS232/RS485 and fasten it tight or plug in the FO cable and secure it. If you are not using the Sub D connector for RS232/RS485, attach the red cover supplied.

Set the DIP switches for serial mode (RS232 / 485 / FO).

Maintenance and Cleaning

The device is maintenance-free. Use only a dry cloth for cleaning.

Never use liquid or aerosol cleaning agents.

Practical Safety Information

As is the case for all electrical equipment, there are some basic safety precautions to be taken. These safety precautions are primarily for your own protection but also prevent damage to the device.

Settings not described in the manual, and changes to the device electronics can only be carried out by an authorised vendor.

Read the device manual carefully and keep it close at hand.

Make sure that ...

- the device is always connected to protective earth
- the device is never placed near a heating source or the outlet of an air-conditioning unit.
- the device is never exposed to direct sunlight.
- the device never comes into direct contact with liquids of any kind. Never use liquids in the vicinity of the device.
- opening the housing can lead to electric shock and other damage. Never make any changes to the device that are not permitted in this manual. Doing so could damage the device. Any damage caused by unauthorised handling of the device are done at own risk and own cost of repair or replacement.

Make sure that ...

- the rating of the supply voltage corresponds to the specification on the device main plate. If in doubt, contact your supplier.
- the supply voltage is protected against surges and other disturbances.
- the maximum power rating of the connected cables is not exceeded and conductors have the required minimum cross-section.
- all connected cables are protected against damage.
- a damaged supply voltage cable is replaced immediately.
- the line-side fuse is removed before cleaning the device to ensure complete disconnection from the power source, and precautions are taken to prevent unintentional reconnection.

Preparing the Operating PC or Service Notebook

Before commissioning the Serial Hub, the following precautions must be taken on the on the operating PC or service Notebook:

Installation of the hub driver

To operate a serial hub from a WINDOWS® application in which an Ethernet link is intended to be established, a driver providing a virtual serial COM port must first be installed, using the configuration tool. This is done by installing and setting up the configuration software.

In the application, the virtual COM ports look like interfaces integrated into the PC/Notebook. Up to 255 virtual COM ports (minus the number of physical COM ports) can be installed on a PC/Notebook.

This requires the following operating systems

- Microsoft Windows® XP Prof. 32-Bit SP3
- Microsoft Windows® 7 Prof. 32-Bit SP1
- Microsoft Windows® 7 Prof. 64-Bit SP1
- Microsoft Windows® Server 2008 R2 / 64-Bit

These Windows Operating Systems were used to test the installation as well as the full scope of functionalities of the device.

- **Installing the Configuration Software**

For the installation of the configuration tool corresponding set-up files are available for the various WINDOWS®-Operating Systems.

“ipEther.config.Setup_x86.exe” for Windows® XP SP3 and 7 SP1 32-Bit

“ipEther.config.Setup_x64.exe” for Windows® 7 SP1 64-Bit and Server 2008 R2

There are two ways of configuring the Serial Hub, using the configuration tool, via the Ethernet interface.

1. The Serial Hub is connected directly to the operating PC/Notebook, using a cross-over patch cable. After the configuration tool has been started, the connected Serial Hub is automatically located and can be configured.
2. The Serial Hub is connected with a patch cable to a switch in an existing network, to which the operating PC/Notebook is connected as well. After the configuration tool has been started, all connected Serial Hubs are located automatically and can be configured. To configure Serial Hubs that are located in another network segment (e.g. behind a router), they must be searched for in the network by manually entering the IP address.

- **Configuring the Ethernet Interface of the Operating PC**

In order to enable the operating PC to communicate with the Serial Hub, the Ethernet interface of the operating PC/Notebook must be configured accordingly.

Configuring the LAN Interface of the Operating PC

There are two ways of configuring the Serial Hub on a PC/Notebook using the configuration tool via its Ethernet interface:

Direct PC ↔ Serial Hub LAN connection with "cross-over patch cable"

The Serial Hub is connected directly to the operating PC/Notebook using a cross-over patch cable. A fixed IP address must be assigned to the LAN interface of the computer for this purpose.

Note: If the computer is operated in a company LAN, a variable IP address is usually assigned by the server (see next section). If the Serial Hub is to be configured directly via the cross-over cable with this computer, a fixed IP address must be assigned to this computer for this time.

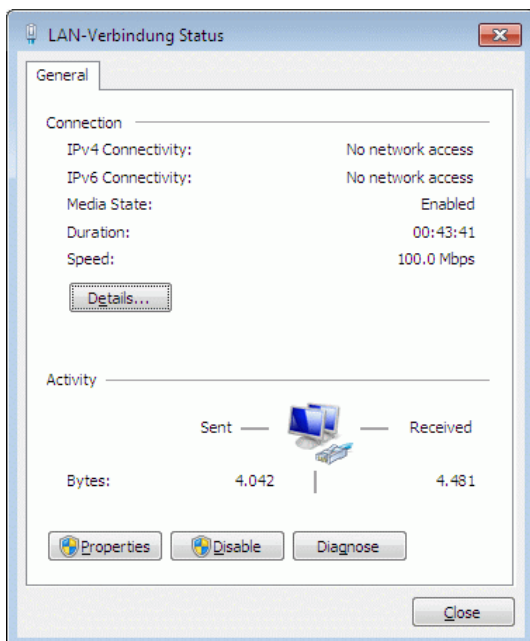

Select the appropriate "Local area connection" under "Connections".

In the "Local area connection status" window, click the "Properties" button to switch to the local area connection settings.

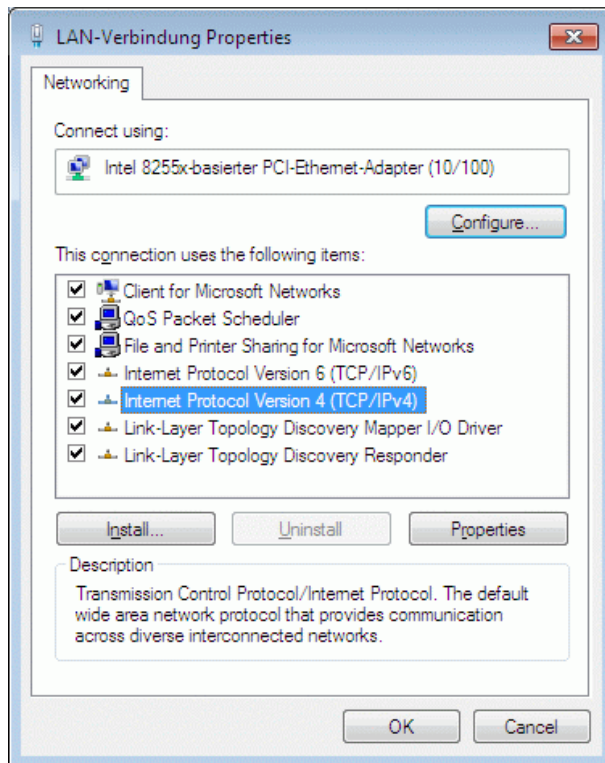

Click the
"Properties"
 button to set the IP address under
"Internet Protocol (TCP/IPv4)"

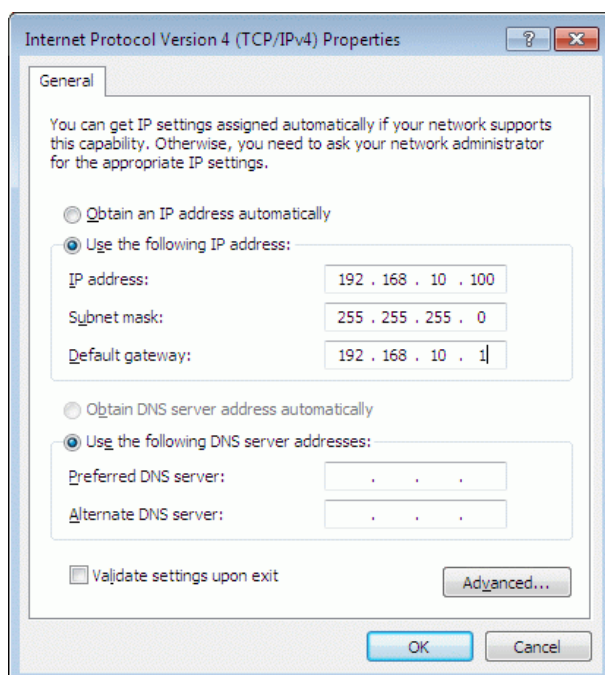

To assign a fixed IP address, select
"Use the following IP address"

Under **"IP address:"**, enter a free IP
 address for private networks, e.g.
192.168.10.100

Under **"Subnet mask:"** enter
 the associated subnet mask
255.255.255.0

Under **„Default Gateway“** enter
 the associated Router address
192.168.10.1.

Confirm with "OK".

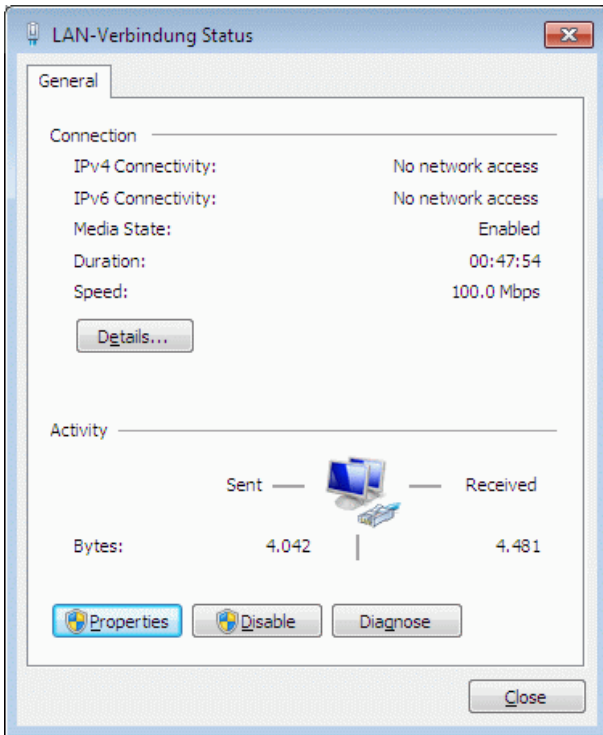

If you want to check the settings of the LAN interface In the "Local area connection status" window, go to

"Details..."

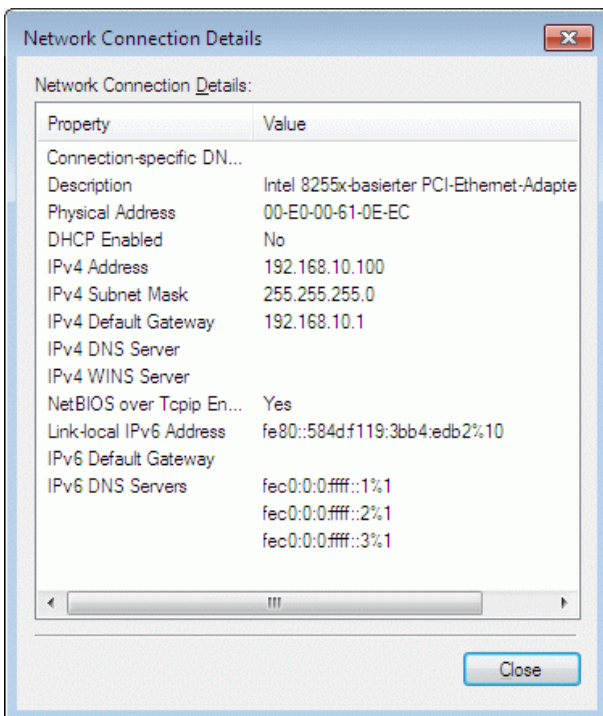

Close the window again with the **"Close"** button.

After you have started the configuration tool, the connected Serial Hub is located automatically and can be configured (see Section "Configuration tool").

PC ↔ Serial Hub LAN connection in an existing network

The Serial Hub is connected with a patch cable (not cross-over cable) to a hub or switch in an existing network to which the operating PC/Notebook is connected as well. The PC usually automatically obtains a free IP address from the server.

The LAN connection of the operating PC to the network can be checked as described in the previous section.

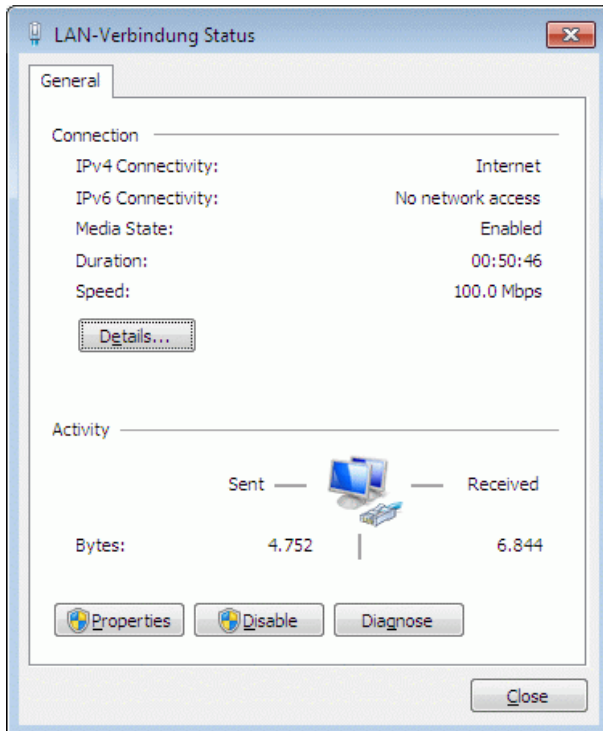

In the "Local area connection status" window, go to

"General"

to display the status of the network connection.

Under **"Details"** you can check at the settings assigned to the connection.

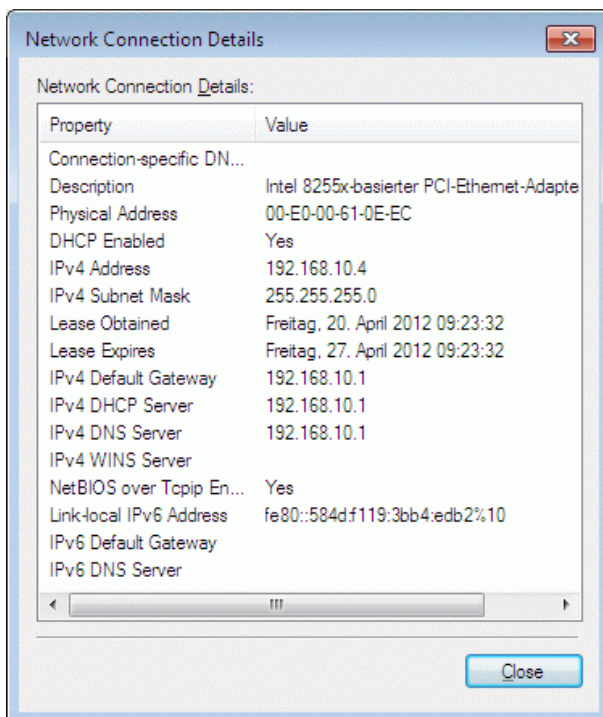

Here, the network addresses are automatically assigned by a DHCP server in the network.

After you have started the configuration tool, all Serial Hubs connected in the same network segment are located automatically and can be configured (see Section "Configuration tool").

Using "HyperTerminal" via the Serial Interface of a PC

This terminal program is supplied as a standard feature of the operating system WINDOWS® XP.

Start HyperTerminal under:

"Start → Programs → Accessories → Communications → HyperTerminal"

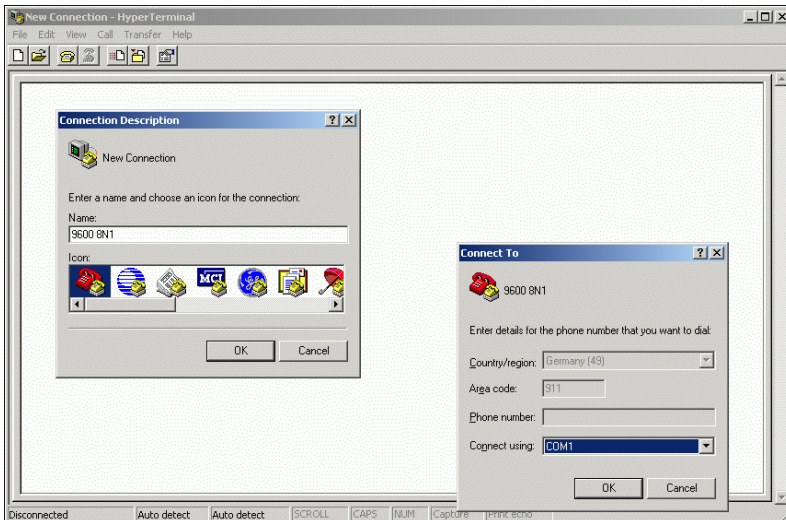

Enter a name for the new connection, e.g. 9600 8N1.

The connection can be saved on exiting.

Assign a PC interface to the connection, e.g. COM1.

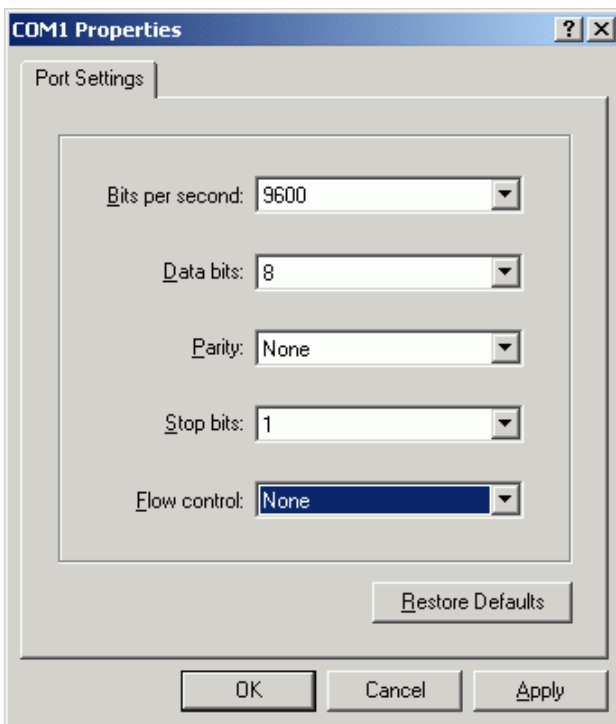

For a **new Serial Hub**, select the settings

9600 bits per second,
8 data bits,
none for parity,
1 stop bit and
none for flow control

Continue with
OK

Note: The Serial Hub data traffic can only be monitored via the serial interface in the currently set baud-rate and data format. If these settings were changed, the connection settings in HyperTerminal will have to be adjusted.

It is advisable to note down these settings to avoid any problems accessing the Serial Hub later.

For Windows XP and WINDOWS 7 the terminal program “**DIGSI Terminal**“ is available on the included CD/DVD as well as in the Internet under www.siemens.com/siprotec.

After starting of the program, this is self-explanatory.

- select COM-Port
- set baud-rate as well as the data format
- press the button “connect

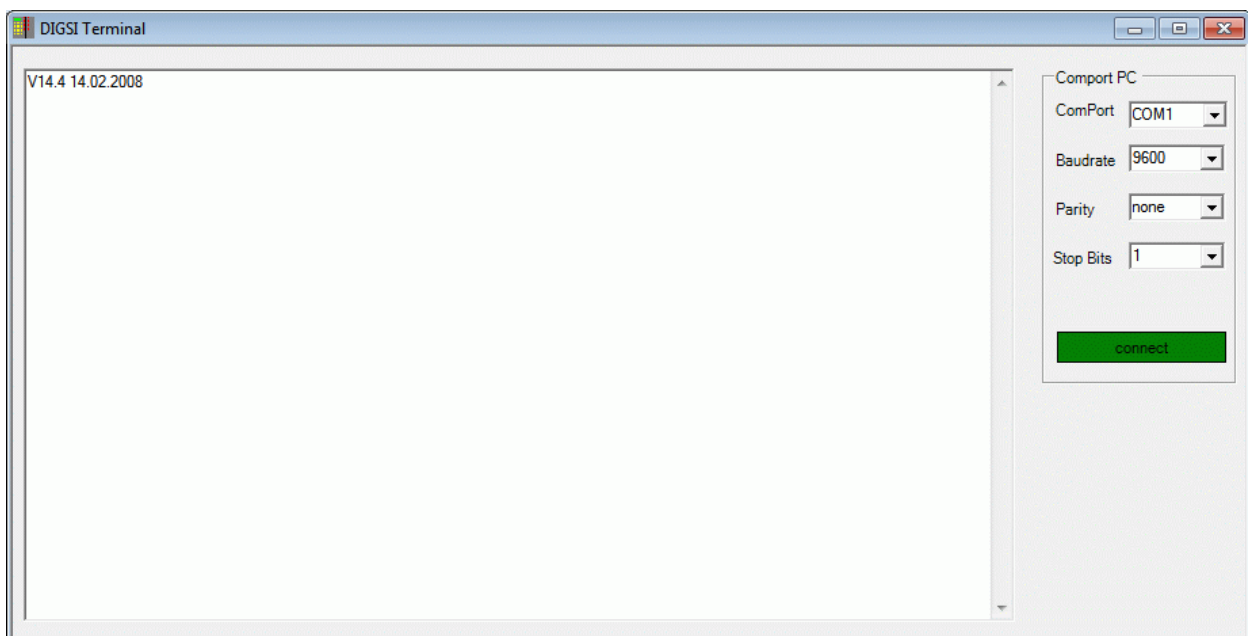
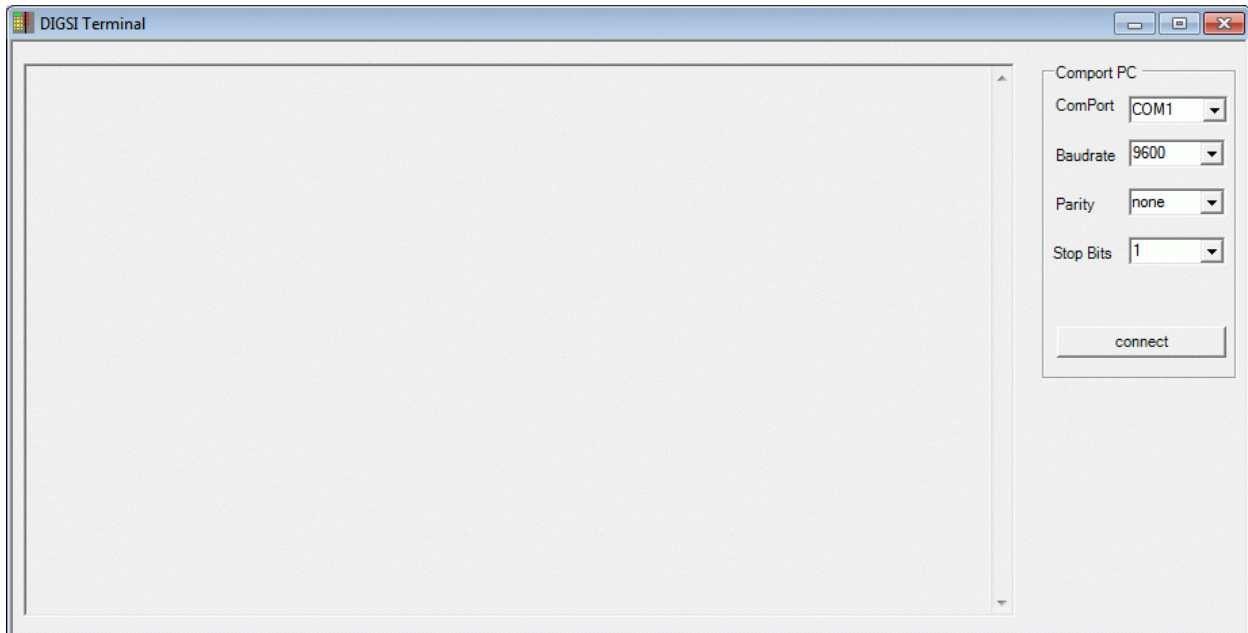

Out-put of the Firmware after pressing in the INIT-key of the Serial Hub.

Note: Entered characters are not displayed. To enable this, the “Echo” has to be activated with the command “ATE1” on the connected device such as for example a modem.

The Configuration Tool

Installation of the configuration tool V15

Pre-requisite is one of the following operating systems:

- Microsoft Windows® XP Prof. 32-Bit SP3
- Microsoft Windows® 7 Prof. 32-Bit SP1
- Microsoft Windows® 7 Prof. 64-Bit SP1
- Microsoft Windows® Server 2008 R2 / 64-Bit

The configuration tool may be found on the included CD/DVD as well as in the Internet under www.siemens.com/siprotec.

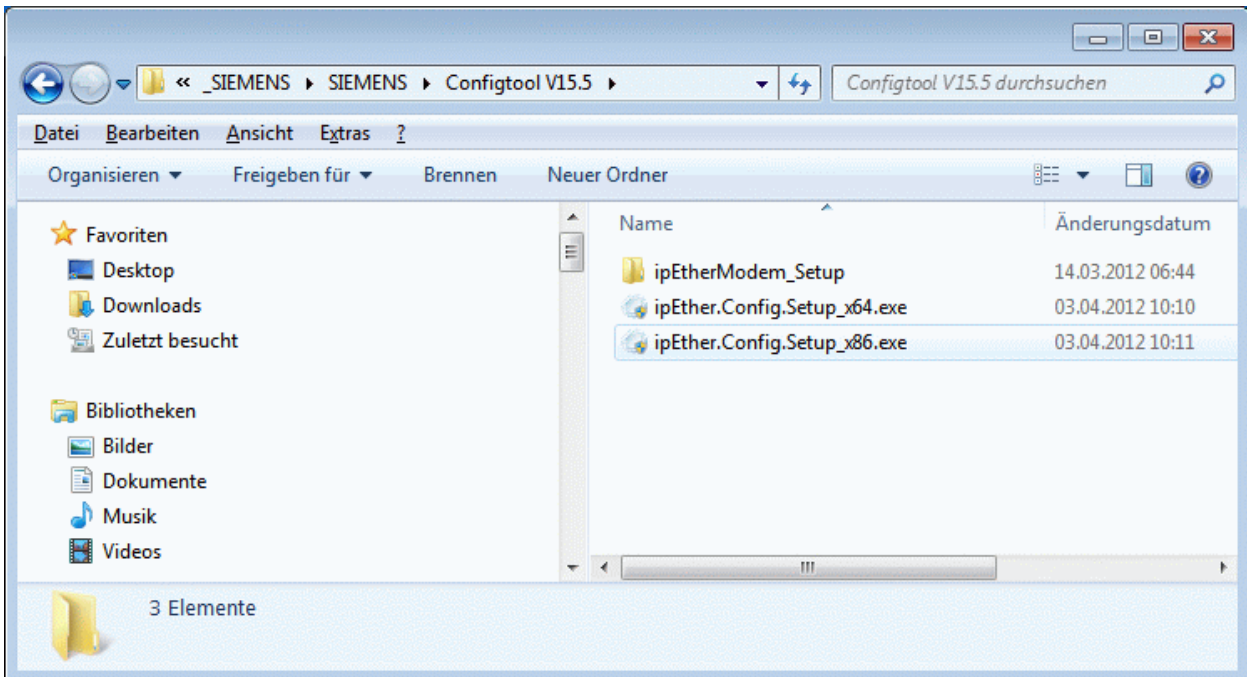

- Selection of the set-up filing directory in the WINDOWS® Explorer
- Start of the installation on the operating PC by double-clicking on the file :
- “ipEther.config.Setup_x86.exe” for Windows® XP SP3 and 7 SP1 32-Bit
- “ipEther.config.Setup_x64.exe” for Windows® 7 SP1 64-Bit and Server 2008 R2.

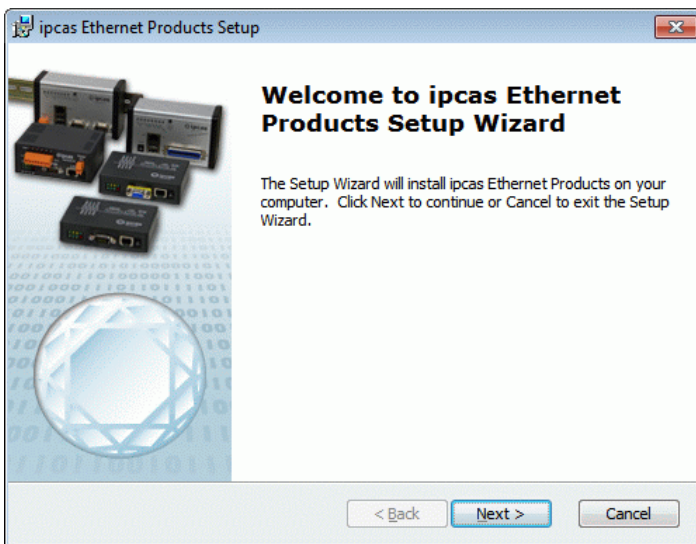

Continue the installation with
“Next >”

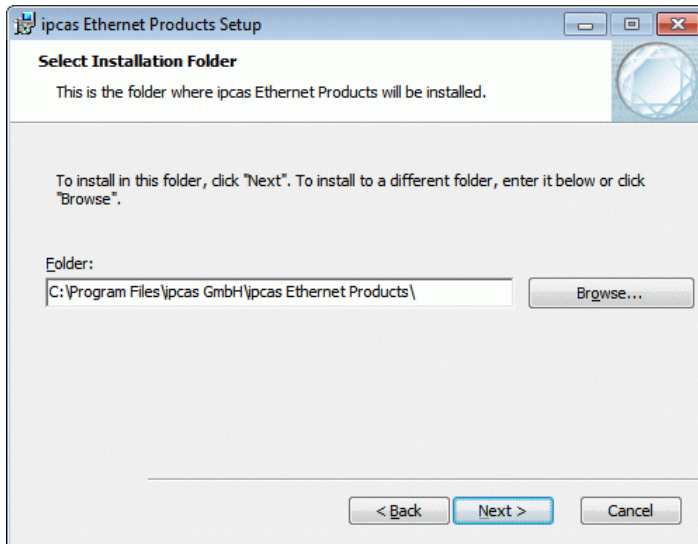

With “**Browse...**” the pre-set installation path can be altered.

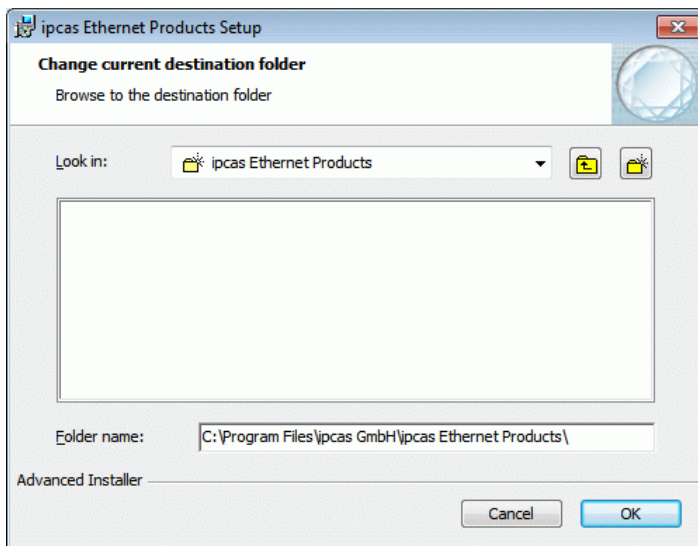

Select the installation folder here or create a new folder

Continue with “**OK**”

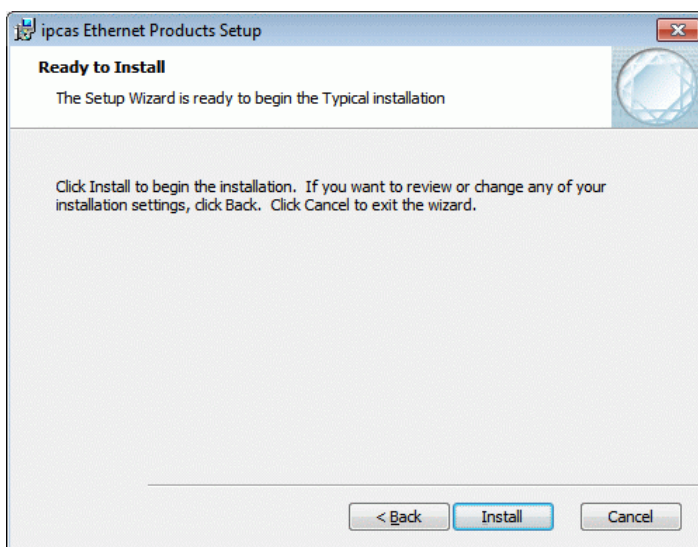

By selecting “**Install**” the configuration tool is installed on the operating PC.

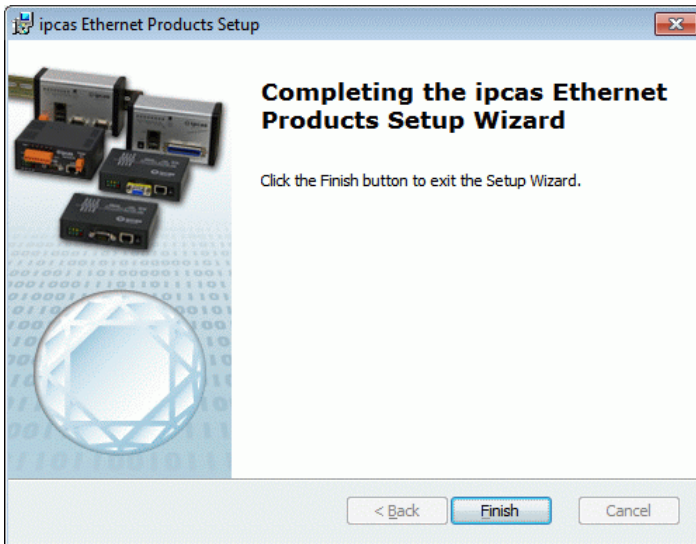

When this window is displayed the installation has been completed successfully and the process is completed with **“Finish”**.

The configuration tool may be started on the desktop of the PC/Notebook with the icon **“Configuration Utility”**.

De-installation of the configuration tool

The de-installation of the program may be carried out via **WINDOWS® System Control Panel-> Programs and Functions-> ipcas Ethernet Products**. Alternatively it may be done by starting the installation directory, ipEther.config.Setup_xyy.exe.

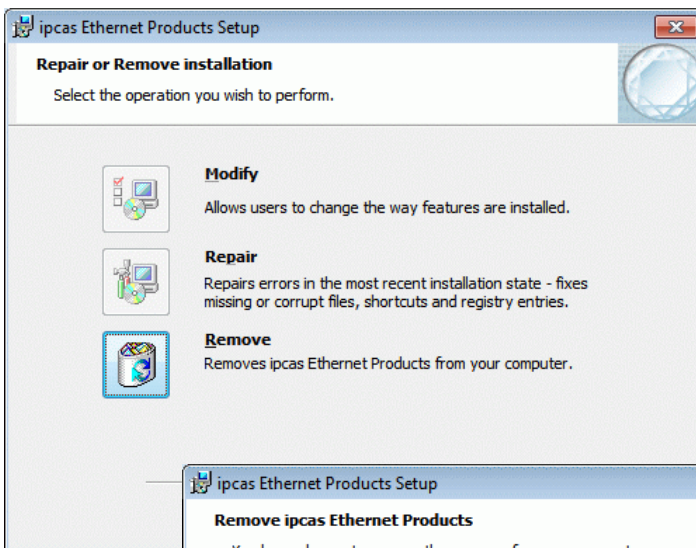

For de-installation select **„Remove“** in both windows and confirm the entries.

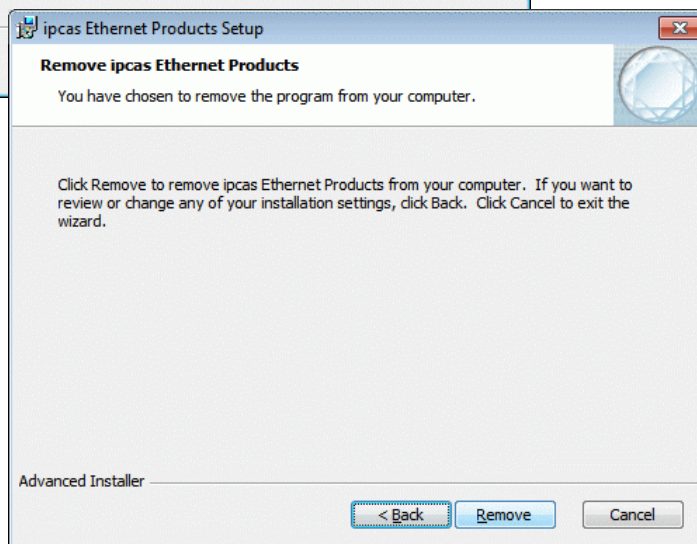

Configuring the Serial Hub with the Configuration Tool

The configuration tool is used to install the basic settings. Start the configuration tool and all serial modems and settings may be viewed in the displayed list.

For this purpose, the configuration tool is started and finds all Serial Hubs in the same network segment which it then lists in a table.

Overview Window

The configuration program locates all devices in its own network segment, even those without a valid IP address.

If the settings (Properties) are to be carried out or changed under Windows 7, the Configuration tool must be opened as Administrator. If the Tool has been started without administrative rights this is displayed in the header.

Name	IP Address	Subnet Mask	Gateway	MAC	Device Type	Version	Info	In Use	UDP Port 3497	In Local Net	Password	Logged In	CPU ID
	10.10.5.1	0.0.0.0	0.0.0.0	00.09.8e.00.05.54	Siemens_Modem	14.7		NO	NO	YES	NO	YES	0427
Zentrale	192.168.10.110	255.255.255.0	192.168.10.254	00.09.8e.00.01.5f	Siemens_Modem	14.7		NO	YES	YES	NO	YES	0426
UW Sud	192.168.10.120	255.255.255.0	192.168.10.254	00.09.8e.00.05.50	Siemens_Modem	14.7		NO	YES	YES	NO	YES	0427
UW Mitte	192.168.10.154	255.255.255.0	192.168.10.1	00.09.8e.00.3d.96	Siemens_Serial_Hub	14.4	COM20	NO	YES	YES	NO	YES	0427
UW Nord	192.168.10.160	255.255.255.0	192.168.10.1	00.09.8e.00.3d.9e	Siemens_Serial_Hub	14.4	COM21	NO	YES	YES	NO	YES	0427

Clicking on the column header in the overview, e.g. "IP address", sorts the devices in ascending or descending order of the items in that column.

Items in the Overview Window:

Name	Serial Hub name for better identification by means of a self-explanatory text.
IP Address	Current IP address
Subnet Mask	Current Subnet Mask
Gateway	Current Gateway
MAC	Worldwide unique MAC address
Device Type	Device Type
Version	Current firmware version
Info	Currently configured COM port (not available for Serial Hubs)
In Use	If the entry is "YES", the device is in connection mode and it is not possible to make changes to the settings.
UDP-Port 3497	If this entry is "NO", the device will no longer be found. It is not connected, deactivated, or is behind a router that is blocking the UDP port 3497.

in local Net	If this entry is "NO", the device is not in the local network segment. If the device is installed behind a router, the IP address cannot be changed. This prevents the device from being accessed unintentionally.
Password	If this entry is "YES", the device is password-protected and the password must be entered before configuration (by right-clicking on "login"). <i>If the password is forgotten, the device must be submitted again (see last page).</i>
Logged in	If this entry is "NO", the password has to be entered before configuration (by right-clicking "login").
CPU-ID	Internal CPU ID (not relevant for users)

General Settings

When the Serial Hub is delivered, no valid IP address has been set yet. The default address is **10.10.5.1**.

A unique IP address must first be assigned to each device.

To set the IP- addresses in the serial hub, the device must be connected in its own network segment. Otherwise the device should be connected to the operating PC, using a "cross-over patch cable".

If the Serial Hub is integrated into a DHCP network the available IP addresses are assigned automatically. The network administrator on the DHCP server **must** assign a **fixed IP address** for the Serial Hub.

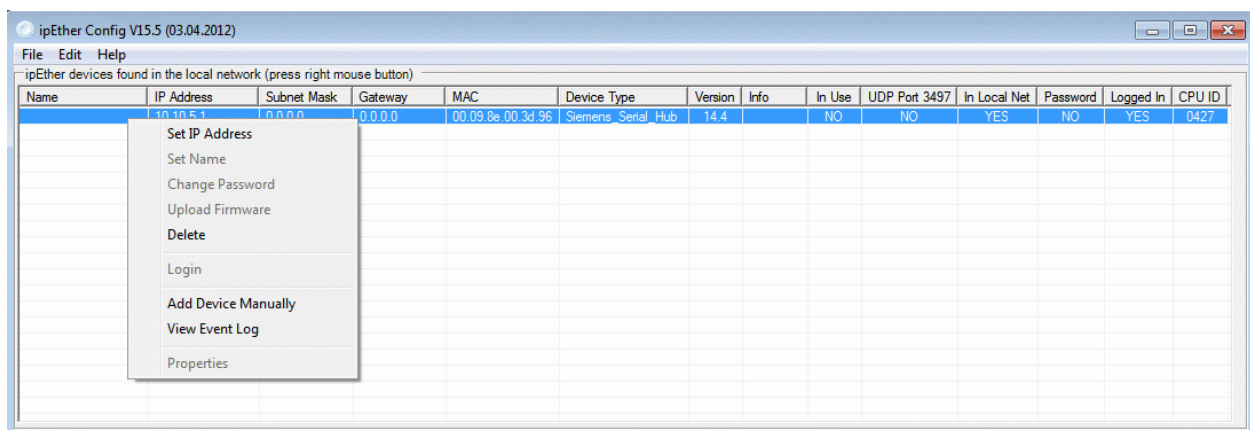

Right-clicking the device entry in the overview window displays a dialog box in which further actions can be performed.

Set IP Address

The screenshot shows a dialog box titled "IP Settings" with three input fields: "IP Address" (192.168.10.154), "Subnet Mask" (255.255.255.0), and "Default Gateway" (192.168.10.1). Below the fields are "OK" and "Cancel" buttons.

Enter a fixed IP address, Subnet-Mask and Default-Gateway for operation of the Serial Hubs in a network.
If the allocated IP-address and the Subnet-Mask are not compatible the properties cannot be changed any longer. In this event please change the settings.

Set Device Name

The screenshot shows a dialog box titled "Device Name" with a single text input field containing "UW Mitte". Below the field are "OK" and "Cancel" buttons.

Enter the name of the Serial Hub for a more transparent overview in the table.

Change Password

The screenshot shows a dialog box titled "Change Password" with three input fields: "Old Password", "New Password", and "Retype New Password". The "New Password" and "Retype New Password" fields are masked with asterisks. Below the fields are "OK" and "Cancel" buttons.

Before a password can be assigned or altered, the old password has to be entered. Then enter the desired new password twice.
No password has been set on delivery, which means that the space "Password" remains unfilled with the first change.
If the password protection is to be deactivated, the old password is entered and the empty spaces of the „New Password“ are confirmed with "Return".

In the case of a forgotten Password, the device must be sent in.

(For the relevant address, refer to the last page of this manual)

Upload Firmware

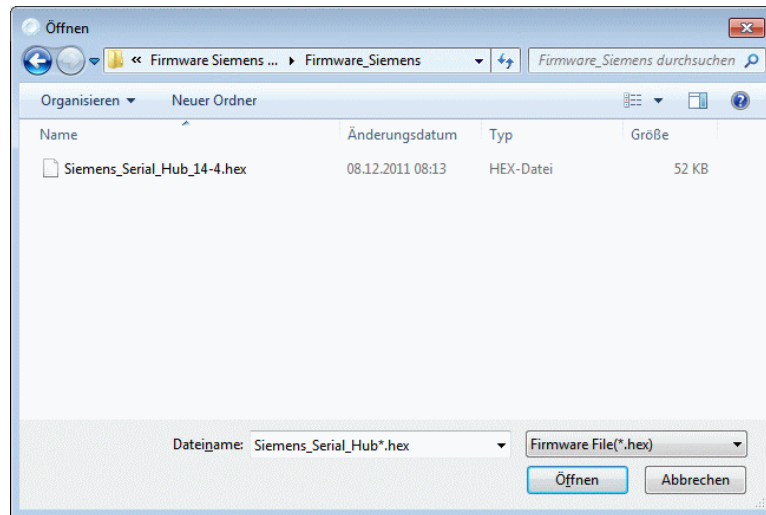

Locate the new firmware version and import it with "Open" or by double-clicking.

The firmware update re-sets the Serial Hub to its factory settings (default settings). Passwords and IP-address are not re-set.

If the message: "Can't upload Firmware. See Logging" appears during a firmware update, please repeat the upload until the message: "device is up again" appears.

The configuration tool may be found on the included CD/DVD as well as in the Internet under www.siemens.com/siprotec

Delete

Currently marked entry is deleted.

Add Device Manually

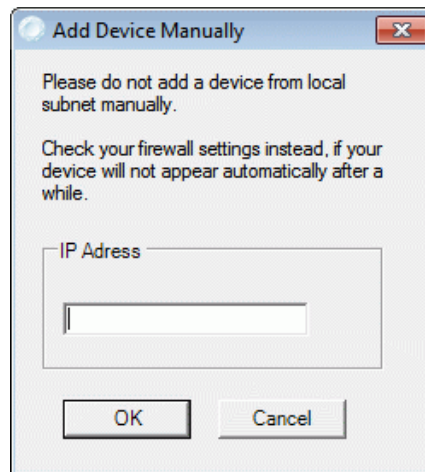

If the Serial Hub is connected behind a router, it is not located automatically but must then be added manually ("Add Device manually"). This is done by entering its IP address in the required space. If the device can be accessed at this address, it is imported into the list.

Note: If the device is installed behind a router, the IP address cannot be changed. This prevents the device from becoming unaccessible by mistake.

View Event Log

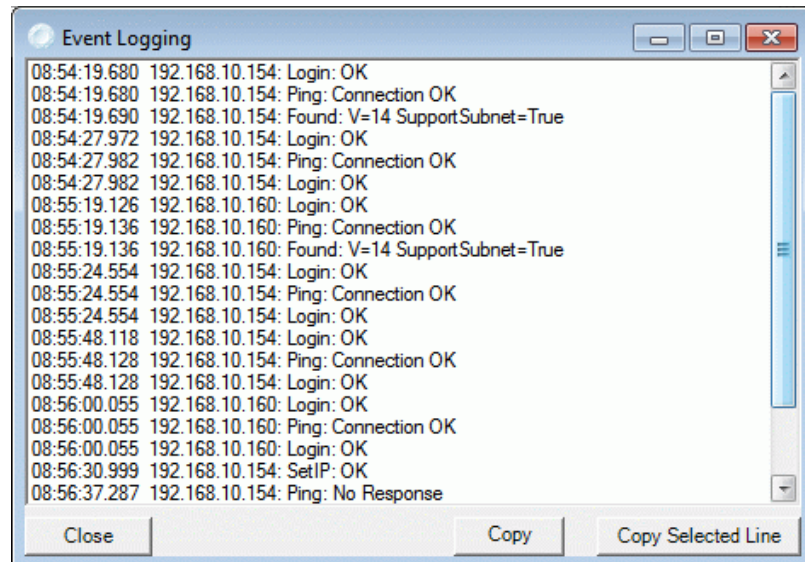

View current log-file (internal trace)

Properties

Type-specific configuration user surface

For more information, see the relevant chapters in this manual.

Important Notes regarding the properties and storage file as well as the correct start and termination of communication.

Only the „IP-Address“, „Name“ and „Password“ are stored in the Serial Hub.

The „virtual COM-Port“, the related „IP-Addresses“ and „all other settings“ (Properties) are only saved on the respective operating PC in an XML file.

The settings (Properties) of the operating PCs and the serial hubs are displayed in a list or settings window in the Configtool. These settings (Properties) can be exported from the Configtool and imported to a different PC or Notebook..

Each time the COM-Ports is opened “all other settings” along with the “baud-rate” and “data format” are transferred from the application to the Serial Hub. After termination of the communication, the application has to correctly terminate the application.

If more than one operating PC is used to access the same Serial Hub, then these settings must be applied to all these operating PCs. The virtual COM-Port for a particular Serial Hub may be the same or different on various operating PCs.

If the Serial Hub is “in use”, i.e. it is connected to an operating PC, it is barred for all other operating PCs and the allocated COM-port for this Serial Hub is not shown in the application. This avoids a data collision and is as such a “multi master system”. The Configtool displays this under „In Use“ with „YES“.

Properties

If the settings (Properties) are to be carried out or changed under Windows 7, the Configuration tool must be opened as Administrator. If the Tool has been started without administrative rights this is displayed in the header.

ipEther Config V15.5 (03.04.2012)

ipEther devices found in the local network (press right mouse button)

Name	IP Address	Subnet Mask	Gateway	MAC	Device Type	Version	Info	In Use	UDP Port 3497	In Local Net	Password	Logged In	CPU ID
UW Mitte	192.168.10.154	255.255.255.0	192.168.10.1	00.09.8e.00.3d.96	Siemens_Serial_Hub	14.4		NO	YES	YES	NO	YES	0427

Double-clicking the device entry in the overview window displays a dialog box in which additional settings may be made.

A detailed dialog box consisting of six setting tab cards opens:

Siemens Serial Hub V14.4 Properties

TCP/IP | TC57 | RS232 | PortAssignment | INet Info | About

Info

MAC: 00.09.8e.00.3d.96

IP: 192.168.10.154

Name: UW Mitte

OK Apply Cancel

TCP/IP Settings

"Info" displays the **MAC address**, **IP address** and the **Device name**

These settings can only be altered under „General Settings“.

TC57 Settings (Ethernet)

If a frame in TC57 format is received via the RS232 interface, it is immediately sent via Ethernet without a "timeout". This procedure clearly increases the performance of the connection and ensures uninterrupted transmission of frames.

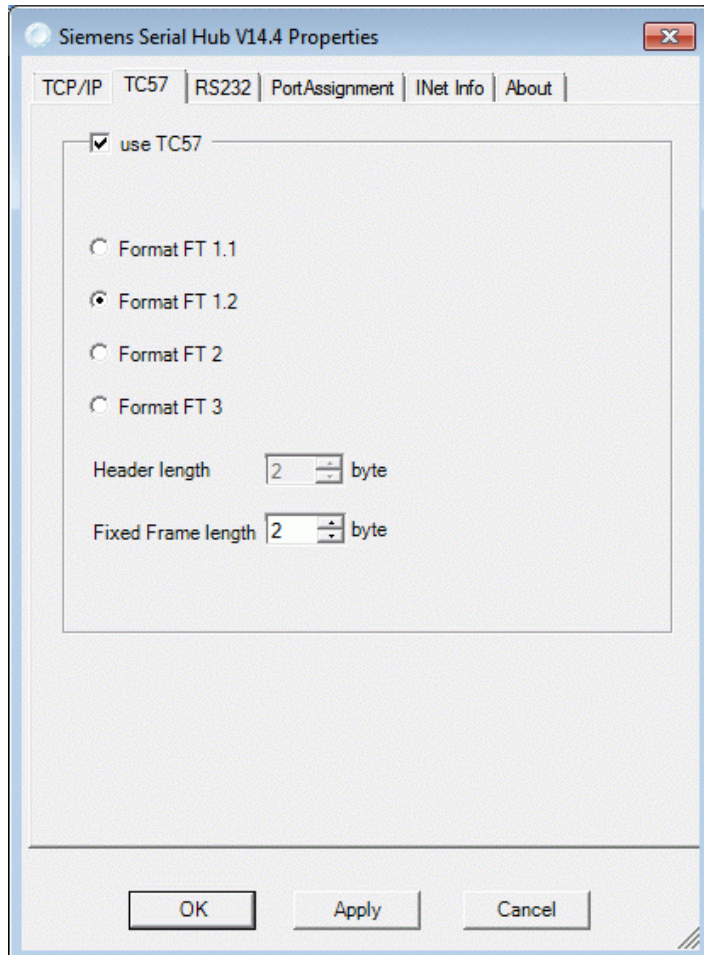

The IEC 60870–5–1 and IEC 60870–5–2 standard defines four standard frame formats for the data link layer.

They are:

TC57 Format FT 1.1

TC57 Format FT 1.2

TC57 Format FT 2

TC57 Format FT 3

Frame formats FT 1.2, FT 2 and FT 3 have a frame of fixed length.

The frame with variable length for FT 2 and FT 3 has a header of fixed length. This contains "Start character", "Length", "User data" and "Checksum".

The user must select the required format and enter the values for "Fixed frame length" and "Header length".

The value in the "Fixed frame length" edit box is in the range of 2 to 255 bytes.

The value in the "Header length" edit box is in the range of 2 to 14 bytes. The value only refers to "User data" from the header.

Note: For the protocols IEC60870-5-103, VDEW or for the protocol used by DIGSI®, the format FT 1.2 (Header length = 0 byte and Fixed Frame length = 2 byte) is required.

RS232 Interface Settings (RS232 / RS485 / FO)

These settings adapt the settings of the serial interface of the Serial Hub to that of the terminal device. The terminal device may, for example, be a protection device with a serial interface (SIPROTEC®). These settings apply to all possible connections (RS232 or RS485 or FO).

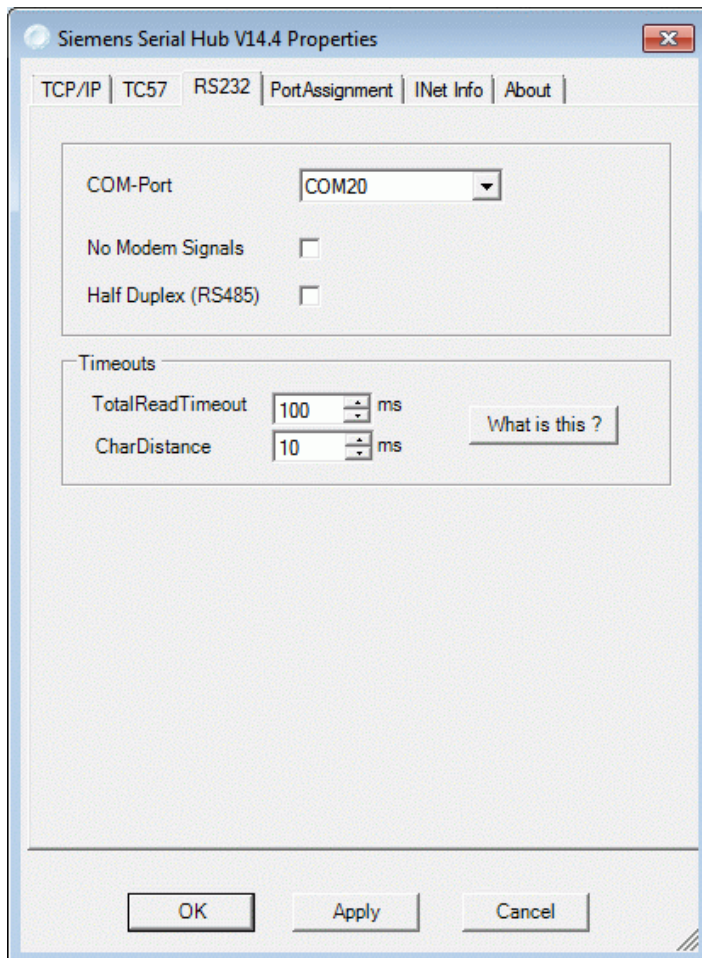

The RS232 settings are adapted to the communication behaviour of the serial terminal device.

Com port describes the virtual COM port to be used. (Up to 255 COM ports minus the number of physical COM ports are available.)

No Modem Signals has no effect here and is not set.

Half Duplex (RS485). The RS485 can be operated in the half-duplex or full-duplex mode (RS232 and FO).

Under **TotalReadTimeout**, it is usually in order to apply the default value of 100 ms. The ideal signal throughput time can be ascertained with the "ping" tool (see below) or the "INet Info" dialog box.

CharDistance (i.e. character interval) with default value 5 ms should only be changed in exceptional cases.

NOTE : The settings for baud-rate, data bits, parity and stop bits are done by the application (e.g. DIGSI®). This establishes a link to the Serial Hub via the driver for the virtual COM port and transfers the serial interface settings for communication to the terminal device.

Port assignment (Export / Import / Delete)

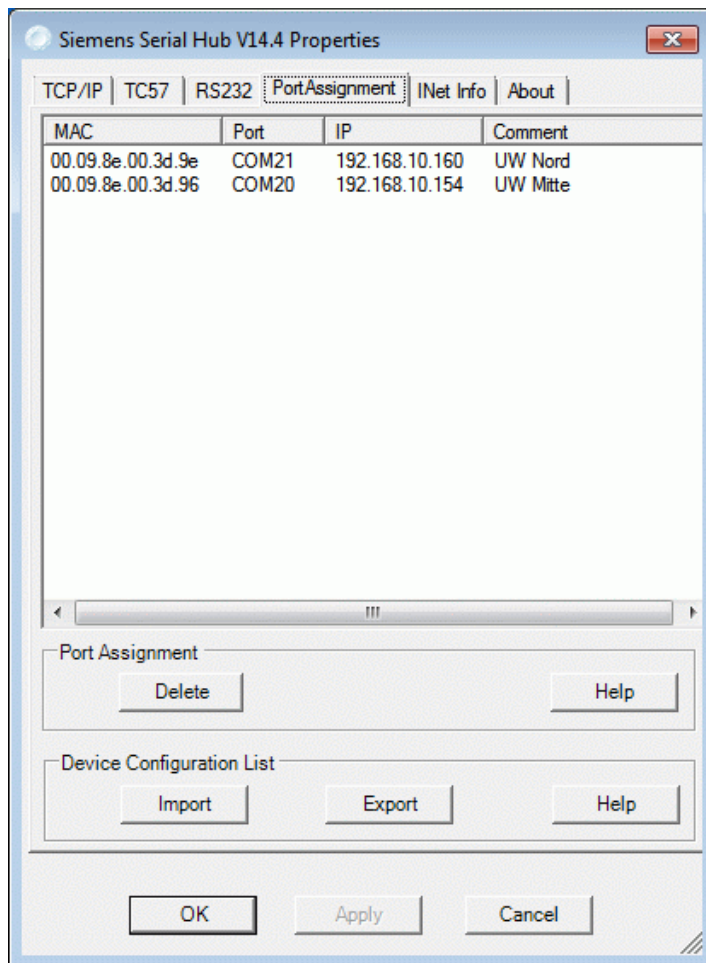

In this selection the allocation of the virtual Com-Ports of all Serial Hubs to the MAC and IP addresses, as well as the name of the PC/Notebook are displayed.

If a device is marked, the allocation of the XOM Port can be deleted with the button **“Delete”**

The IP-addresses and names remain stored in the serial hub, all other settings are deleted in the PC /Notebook.

With the buttons **„Export“** and **„Import“** the **„Device Configurations List“** can be saved on the PC and again imported onto another PC.

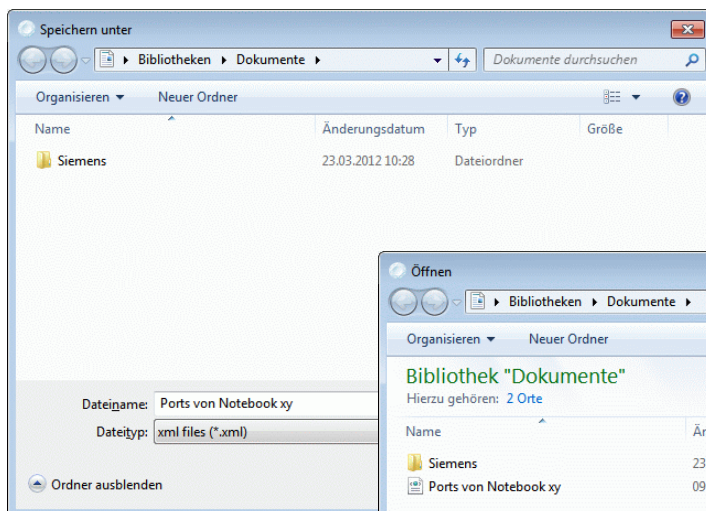

With the button **“Help”** further information on this topic can be obtained.

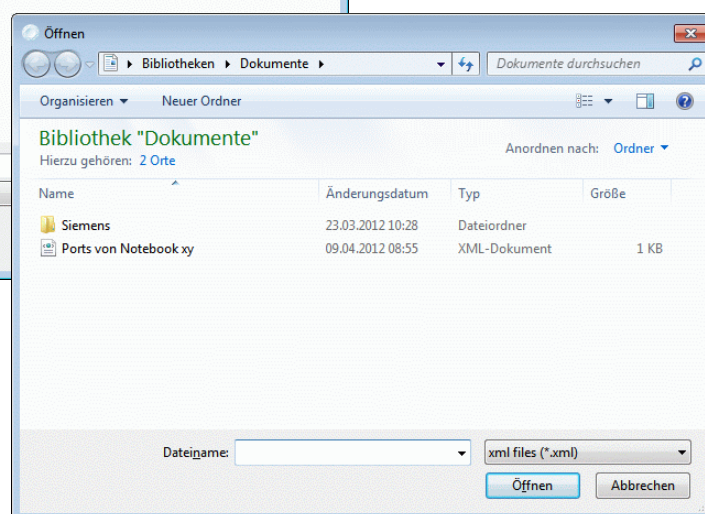

INet Info

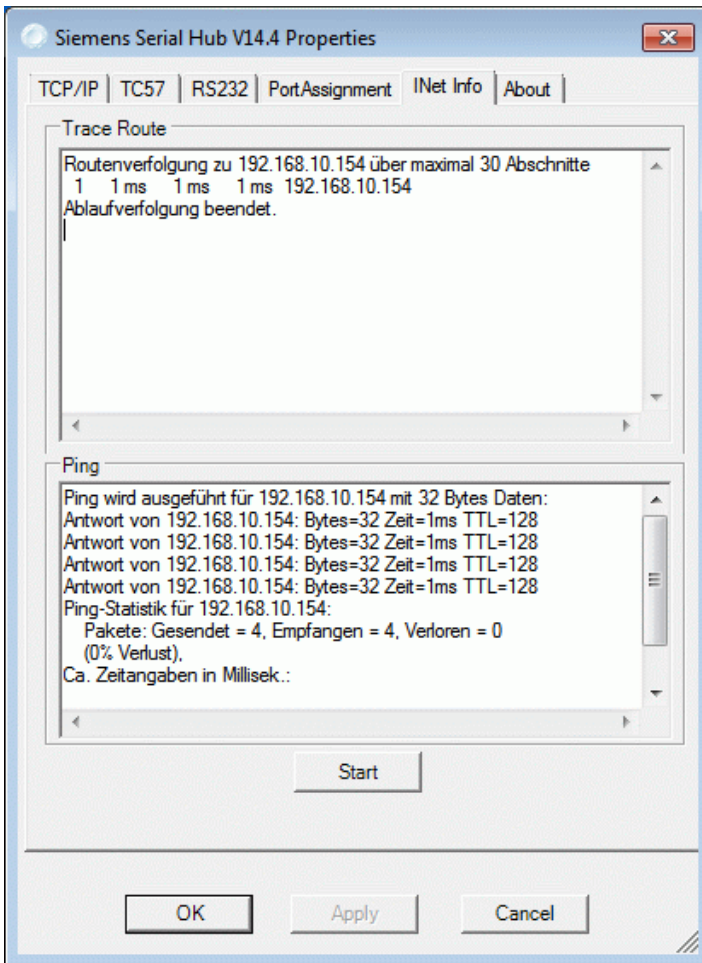

This window provides up-to-date network information.

The "**Start**" button transmits a **ping** to the Serial Hub to ascertain the throughput time of the telegrams in the network.

About

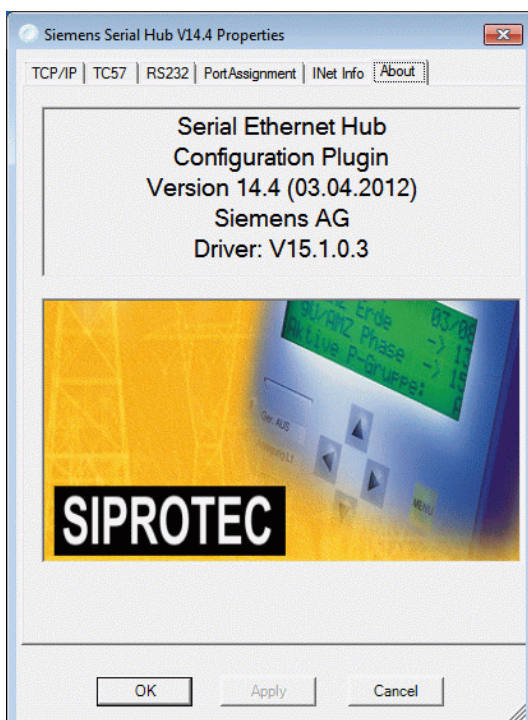

This window provides information about the configuration- and driver version and the date of issue of this configuration tool.

If the PC has Internet access, you can double-click the image for direct access to our

Download Area.

All up-to-date documents, drivers and updates for our products are available under

www.siemens.com/siprotec

Optimising Data Transfer

Great emphasis has been placed on compatibility in the design of this device. Due to the Ethernet, there are, however, some minor restrictions. Data is not transmitted in bytes to the network. This is done in data blocks via Ethernet. This might result in minor delays. Block formation function does not directly affect the application but might help to reduce the network load. Some fine tuning might be necessary for time-critical applications. This involves the two timeout parameters ("Total Read Timeout", "Character Distance").

Block Formation for Serial Data before Transmission into the Ethernet

After the first byte has been received, "Total Read Time" starts. After the time expires, all characters received so far are relayed to the Ethernet. The default value is 50 ms.

"Character Distance" is the maximum interval between two received characters. If this is exceeded, all characters received so far are transmitted into the Ethernet. The default value is 5 ms.

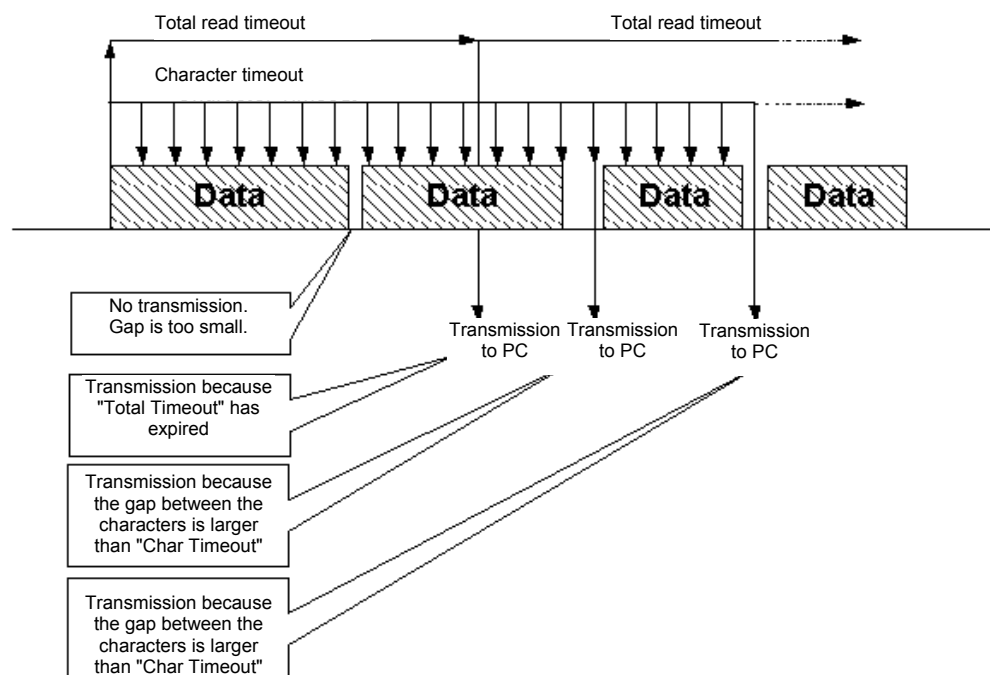

Protocol Code TC57 for Transmission into the Ethernet

This procedure considerably enhances transmission rates when TC57 compatible protocols are transmitted. If the RS232 interface detects a protocol package of this type, it is transmitted as a block via the Ethernet immediately, without waiting for a timeout to elapse.

The Serial Hub can be adapted to various standards.

The IEC 60870–5–1 and IEC 60870–5–2 standards define four standard frame formats for the data link layer:

0 = Format FT 1.1	2 = Format FT 2
1 = Format FT 1.2	3 = Format FT 3

Frame formats FT 1.2, FT 2 and FT 3 have a frame of fixed length.

The frame with variable length for FT 2 and FT 3 has a header of fixed length. This contains "Start character", "Length", "User data" and "Checksum".

The user must select the required format and enter the values for "Fixed frame length" and "Header length".

Protocol code for IEC 60870-5, VDEW and DIGSI®

The IEC 60870–5–102 / 103, VDEW, DIGSI® V3 and DIGSI® 4 protocols are identical to or similar to this specification so that the protocol code of this Serial Hub can be used.

This is done by activating the protocol code, selecting format FT1.2 and setting a fixed frame length of 2 bytes.

Selecting a Password-Protected Serial Hub

The password is used for activation of the configuration mode with the configuration tool as well as for establishing the link. If no password is assigned, this must be entered in the configuration tool under 'Password required'=false.

Entering a Password

To enter a password enter 'Change Password' in the configuration tool and enter the password under 'New Password' and then under 'Retype New Password' before pressing "Enter". The password can have up to 8 digits.

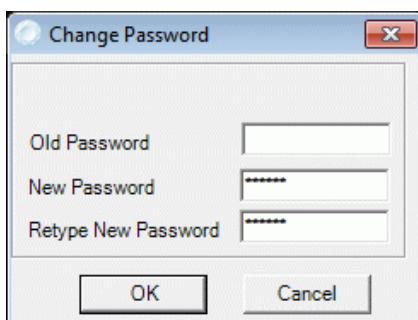

To be able to access a password-protected Serial Hub from the computer from which the application is to be started, the password must be entered on this computer.

Entering the log-in

To access parameter entry from the configuration tool, an assigned password must be entered in 'Login'.

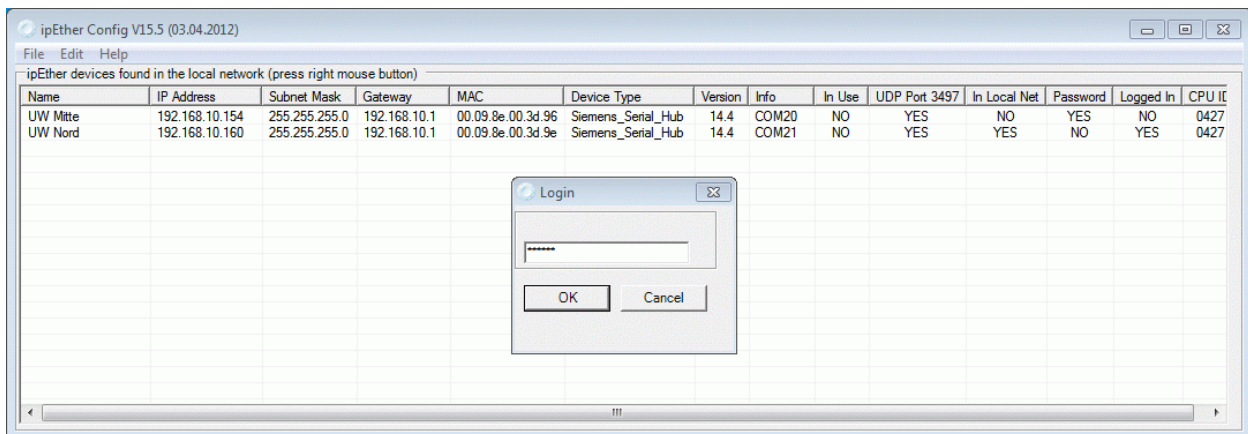
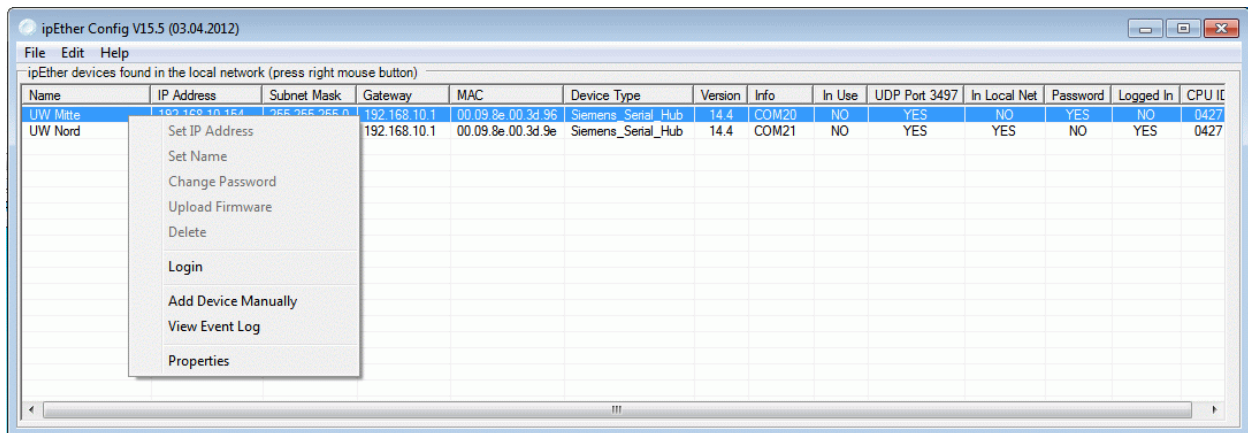

Entering an Incorrect Password

If you enter the wrong password, the message "Invalid Password" is displayed.

Pin Assignment

The cables for RS232 and RS485 are connected to the same port and selected using the DIP switches.

RS232 Interface

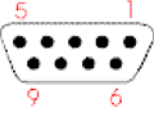
SERIAL PORT 9-pin SubD connector	Pin	Direction	Definition
		1	
2		INPUT	RXD Receive Data
3		OUTPUT	TXD Transmit Data
4			not connected
5			GND Ground (ext)
6			not connected
7			not connected
8			Do not assign !
9			not connected

RS485 Interface

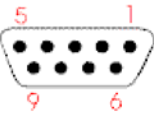
SERIAL PORT 9-pin SubD connector	Pin	Direction	Definition
		1	
2			Do not assign !
3		INPUT/ OUTPUT	RS485 Data-A
4			not connected
5			GND Ground (ext)
6			not connected
7			not connected
8		INPUT/ OUTPUT	RS485 Data-B
9			not connected

Ethernet Interface

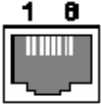
Ethernet connector RJ 45 	Pin	Name	Definition
	1	TX+	Transmit Data+
	2	TX-	Transmit Data-
	3	RX+	Receive Data+
	4	n/c	not connected
	5	n/c	not connected
	6	RX-	Receive Data-
	7	n/c	not connected
	8	n/c	not connected

Ethernet RJ45 connector

Auxiliary Voltage and Earth Connection

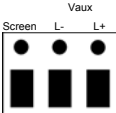
3-way terminal block 	Pin	Name	Definition
	1	L+	V_{aux}^+
	2	L-	V_{aux}^-
	3	Earth	Protective Earth

The device features internal reverse polarity protection for V_{aux} .

DR Contact

2-way terminal block 	Pin	Name	Definition
	1	DR	Isol. DR
	2	DR-NC	Isol. DR-NC

Connecting Cable

RS232 connection options:

- | | |
|--|--|
| 1) PC/Notebook to the protection unit | → plug in serial DIGSI cable directly |
| 2) Serial Hub to SIPROTEC 4 or
7XV5300, 7XV5450, 7XV5550, 7XV5652 | → plug in serial DIGSI cable via gender
changer (male-male) to Serial Hub |

Serial DIGSI Cable

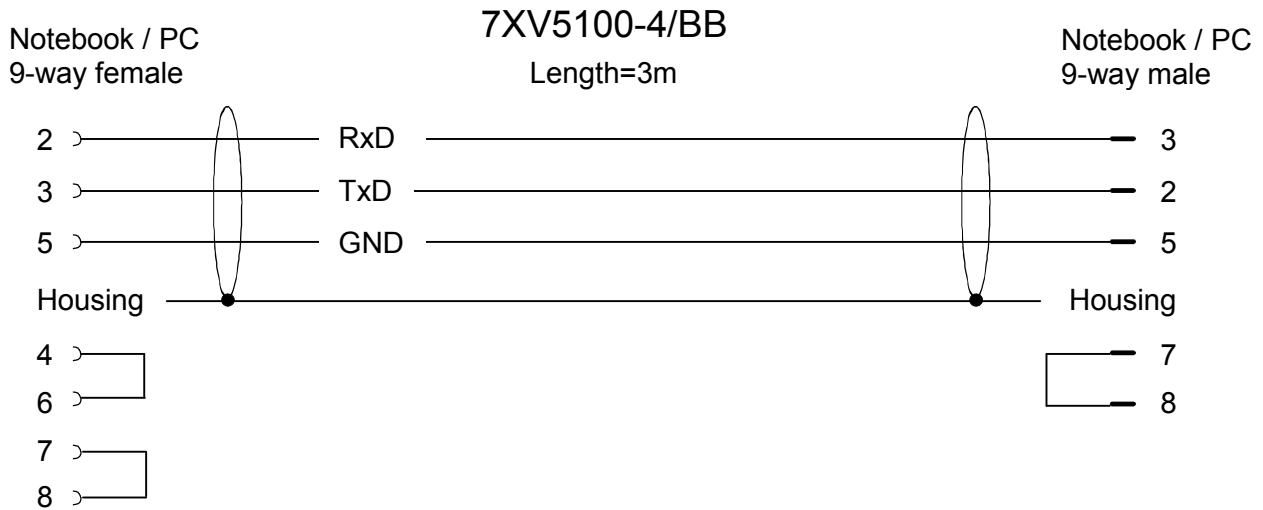

For further cables and adapters, see: www.siemens.com/siprotec

Serial RS485 Connecting Cable

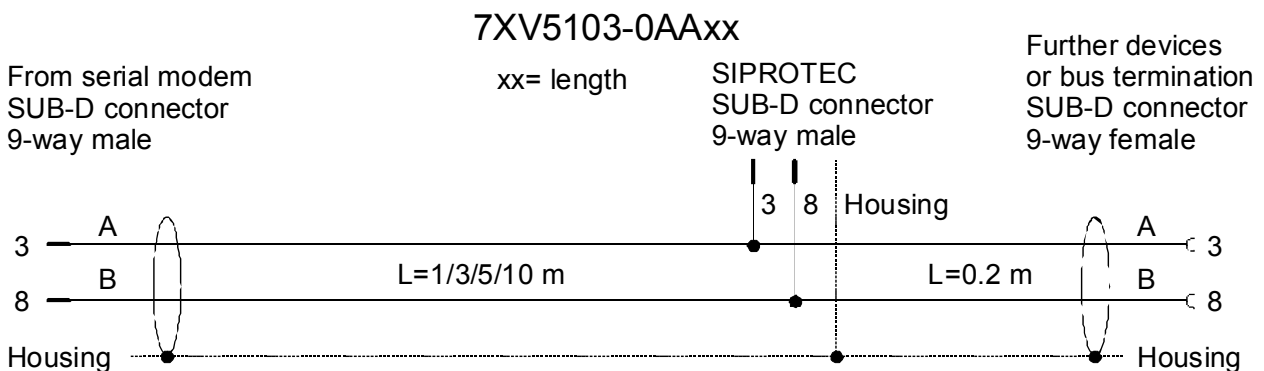

For further RS485 cables and adapters, see: www.siemens.com/siprotec

Technical Data

<p>Auxiliary voltage</p> <p>Power input</p> <p>Line-side fuse</p> <p>Alarm relay (DR) Connection Switching current (continuous) Switching voltage Switching capacity</p> <p>3-way terminal Minimum cross-section of the wires for auxiliary voltage and earth (ground) Nominal conductor cross-section</p> <p>Stripping length: Tightening torque</p>	<p>24 V – 250 V DC +/-20 % 60 V – 230 V AC +/-20 % , 45-65 Hz,</p> <p>2.5 W DC 14 VA AC</p> <p>T 2A/250 V AC and 250 V DC acc. to IEC 60127</p> <p>Relays, 1 NC isolated 2-way screw terminal, 1A 250V AC and DC 20 W / 20 VA</p> <p>1.5 mm²</p> <p>2.5 mm² , rigid conductor or with wire end ferrule up to 8 mm 0.5 Nm</p>
<p>FO connection</p> <p>Connection method Wavelength Fibre Type Baud rate Protocol Laser class</p> <p>Transmit power in dBm , peak (type), NA = 0.275 Max. optical power for high level Min. optical power for low level Optical power budget NA = 0.275 Range</p>	<p>ST connector receiver and transmitter 820 nm Multimode fibre, 62.5/125 µm 2400 up to max. 115200 baud full-duplex 1 acc. to EN60825-1/-2 using glass fibre 62.5/125 µm -12.0 (fibre type 62.5/125 µm)</p> <p>Max. -40 dBm peak Min.: -24 dBm peak Min. 8 dB (62.5/125 µm)</p> <p>Max. 2 Km (attenuation 3 dB / Km 62.5 µm) Max. 2 m with plastic fibre</p>
<p>Ethernet interface Connection TCP/IP</p>	<p>10BaseT (10/100 Mbits) RJ45, screened, 8-way UDP Port 3497 (User Datagram Protocol) ICMP (Internet Control Message Protocol) ARP (Address Resolution Protocol)</p>

<p>RS232 and RS485 Connection type Pin assignment Cable length RS232 Baud rate</p>	<p>9-way SubD connector, 4/40 UNC screw connection See Pin Assignment Max. 10 m / 3280 feet 2400 to 115200 baud, Rxd, Txd Parity : None, Even, Odd, Mark, Space Data : 7 or 8 bits Stop : 1 or 2 bits RS232 : full-duplex , RS485 : half-duplex</p>
<p>DIP switches</p>	<p>RS232/485 switchover Idle state FO ON/OFF RS485 termination</p>
<p>LED displays</p>	<p>DR (GN): Alarm (Vaux power o.k. and reset o.k.) COM-TxD (GN) : Transmit - RS232 or RS485 or FO COM-TxD (YE) : Receive - RS232 or RS485 or FO System (GN) : Connection to the PC via RS232 detected LAN-TxD (GN) : Transmit Ethernet LAN-TxD (YE) : Receive - Ethernet LAN (GN) : Connection to the Ethernet network Error (RD) : hub error on RS232/Reset</p>
<p>Firmware Driver</p>	<p>Updatable Setup & configuration tool for Microsoft WINDOWS® XP SP3 32-Bit, Microsoft WINDOWS® 7 SP1 32/64-Bit, Microsoft Server 2008 R2 64-Bit</p>
<p>Mechanical design Housing Dimensions Weight: Degree of protection acc. to EN60529 Protection class</p>	<p>Plastic See Dimension Drawings Approx. 180 g IP20 (housing and terminals) I Protective Earth</p>
<p>Safety Acc. to DIN EN61010 Part 1 Overvoltage category Pollution degree Fire resistance class (acc. to UL94)</p>	<p>III 2 V0</p>

Standards:	IEC 60255 (product standard) IEEE Std C37.90.0/.1/ VDE 0435 For more standards, see each function
Insulation tests Standards: Voltage test (100% test) all circuits except auxiliary voltage and communication interfaces Voltage test (100% test) on auxiliary voltage Voltage test (100% test) only locked communication interfaces Surge withstand capability test (type test) all circuits except communication interfaces, class III	IEC 60255-5 and IEC 60870-2-1 2.5 kV (rms), 50 Hz 3.5 KV DC 500 V (rms), 50 Hz 5 kV (peak value); 1.2 / 50 μ s; 0.5 J; 3pos./neg. surges at 5s intervals

**Warning**

The 7XV5655-0BA00 is specifically intended for installation in a switchgear cubicle or distribution housing. After installation protective covering must be placed around the entire area of the terminals. Only then is the device sufficiently protected against impermissible contact with live parts.

EMC tests for immunity (type tests)	
Standards:	IEC 60255-6 and -22 (product standards) EN61000-6-2 (generic standard) VDE 0435 part 301DIN VDE 0435-110
High Frequency Test IEC 60255-22-1, Class III and VDE 0435 Part 303, Class III	2.5 KV (peak); 1 MHz; τ = 15 ms; 400 surges per s; test duration 2s; Ri = 200 Ω
Electrostatic Discharge IEC 60255-22-2, Class III	8 KV contact discharge; 15 KV air discharge pos./neg. polarity, 150 pF; Ri = 330 Ω
Irradiation with RF field , frequency sweep IEC60255-22-3, Class III IEC61000-4-3, Class III	10 V/m, 80 MHz to 1000 MHz: 80% AM, 1 kHz

Irradiation with RF field , single frequencies IEC60255-22-3, IEC61000-4-3 - amplitude-modulated - pulse-modulated	Class III: 10 V/m 80, 160, 450, 900 MHz; 80 % AM 1kHz; duty cycle > 10 s 900 MHz; 50% PM, repetition frequency 200 Hz
Fast transients / bursts IEC 60255-22-4 and IEC61000-4-4 Class IV	4 kV; 5/50 ns; 5 kHz; burst length = 15 ms; Repeat rate 300 ms; pos./neg. polarity; test duration 1 min.; Ri = 50 Ω
High energy surge voltages (SURGE) EN61000-4-5 insulation class 3 - Auxiliary voltages - Relay output	Pulse: 1.2/50 μs common mode; 2 kV; 12 Ω; 9 μF differential mode : 1 kV; 2 Ω; 18 μF common mode; 2 kV; 42 Ω; 0.5 μF differential mode : 1 kV; 42 Ω; 0.5 μF
Conducted RF, amplitude-modulated IEC61000-4-6, Class III	10 V; 150 KHz – 80 MHz; 80 % AM, 1 KHz
Magnetic field with power frequency EN61000-4-8 IEC60255-6	0.5 mT; 50 Hz Class IV: 30 A/m continuous; 300 A/m for 3s; 50Hz
Oscillatory Surge Withstand Capability IEEE Std C37.90.1	2.5 kV (peak); 1 MHz; τ = 15 μs; 400 surges per s; test duration 2s; Ri = 200 Ω
Fast transient surge withstand capability IEEE Std C37.90.1	4 kV; 5/50 ns; 5 kHz; burst length = 15 ms; Repeat rate 300 ms; pos./neg. polarity; test duration 1 min.; Ri = 50 Ω
Damped oscillations IEC 60694, IEC 61000-4-12	2.5 kV (peak value), polarity alternating 100 kHz, 1 MHz, Ri = 200 Ω

EMC tests for emission (type tests)	
Standard:	EN 61000-6-4/3 (generic standard)
Radio interference voltage on lines Auxiliary voltage only IEC CISPR 22	150 kHz to 30 MHz Limit class B
Interference field strength IEC CISPR 11	30 to 1000 MHz Limit value class A

Mechanical tests, vibration and shock stress - stationary use	
Vibration IEC 60255-21-1, Class 2 IEC 60068-2-6	Sinusoidal, 10 to 58 Hz : 0.075 mm ampl. 58 to 150 Hz : 1.0 g accel. 20 cycles in 3 orthogonal axes
Shock IEC 60255-21-2, Class 1	Semi-sinusoidal, 5 g accel., 11 ms duration 3 shocks each in both directions of the 3 axes
Seismic vibration IEC 60255-21-3, Class 1 IEC 60068-3-3	Sinusoidal, 1 to 8 Hz : 4 mm ampl. horizontal 1 to 8 Hz : 2 mm ampl. vertical 8 to 35 Hz : 1 g accel., horizontal 8 to 35 Hz : 0.5 g accel., vertical 1 cycle in 3 orthogonal axes

Mechanical tests, vibration and shock stress - during transport	
Vibration IEC 60255-21-1, Class 2 IEC 60068-2-6	Sinusoidal, 5 to 8 Hz : 7.5 mm ampl. 8 to 150 Hz : 2 g accel., 20 cycles in 3 orthogonal axes
Shock IEC 60255-21-2, Class 1 IEC 60068-2-27	Semi-sinusoidal, 15 g accel., 11 ms duration 3 shocks each in both directions of the 3 axes
Shock IEC 60255-21-2, Class 1 IEC 60068-2-27	Semi-sinusoidal, 10 g accel., 16 ms duration 1000 shocks each in both directions of the 3 axes

Climatic tests	
Recommended operating temperature Limit temp. during operation Limit temp. during storage Limit temp. during transport	0 °C to 55 °C -5 °C to +70 °C -25 °C to +55 °C (factory packing) -25 °C to +70 °C (factory packing)
Humidity Maximum relative humidity	80 % at temperatures up to 31 °C, decreasing linearly down to 50 % at 40 °C
Installation altitude Maximum height above sea level	2,000 m

All devices must be installed so that they are not exposed to direct sunlight, nor subject to great fluctuations in temperature that may cause condensation.

Dimensions

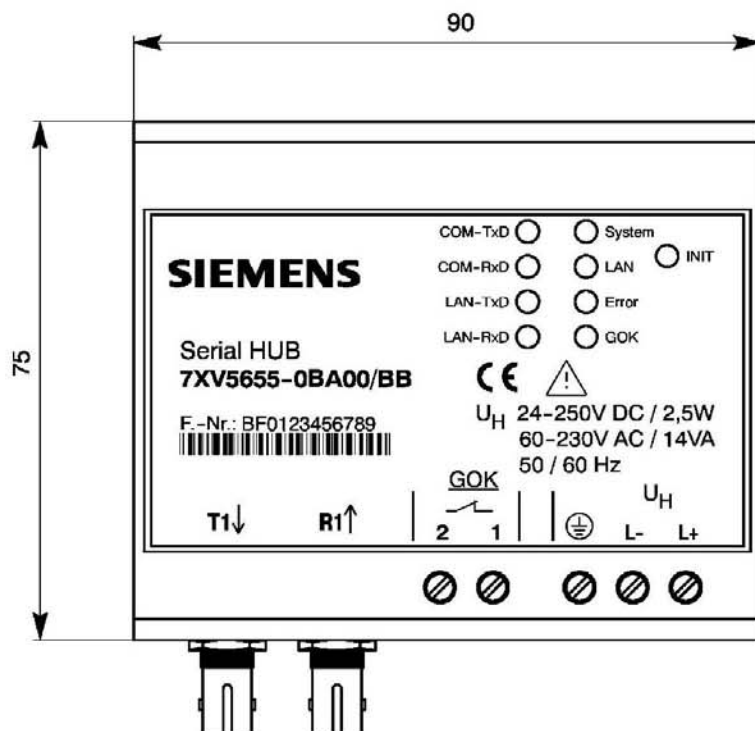
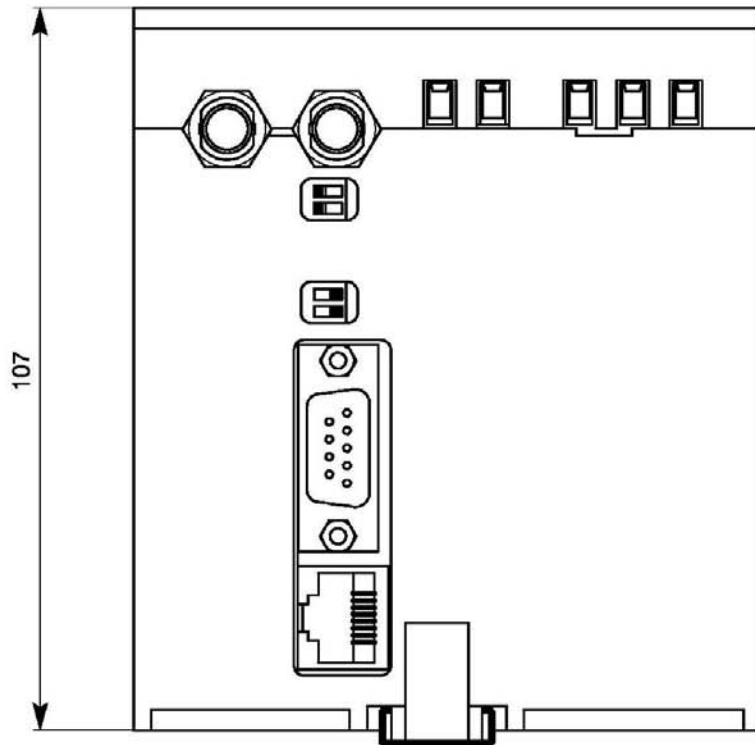

Ordering Information

Name	Order No.
Serial Hub	7 X V 5 6 5 5 - 0 B A 0 0
10BaseT connection 10/100 Mbits, RJ45 connector Serial RS232/485 interface 9-way Sub D connector Gender changer (male-male) FO interface, ST connection DIN rail mounted device for 35mm rail Aux. voltage 24-250 VDC / 60-230 VAC	

If you have any comments or questions regarding this product please contact :

Siemens AG

Infrastructure & Cities Sector
 Smart Grid Division
 Energy Automation

Tel : +49 180 524 8437 (248437 correspondes to "cities" on telephone keypad)

Fax: +49 180 5242471

E-Mail: support.ic@siemens.com

Internet: www.siemens.com/siprotec

Weitergabe sowie Vervielfältigung dieser Unterlage, Verwertung und Mitteilung ihres Inhalts nicht gestattet, soweit nicht ausdrücklich zugestanden. Zuwiderhandlungen verpflichten zu Schadenersatz. Alle Rechte für den Fall der Patenterteilung oder GM-Eintragung vorbehalten.

The reproduction, transmission or use of this document or its contents is not permitted without express written authority. Offenders will be liable for damages. All rights, including rights created by patent grant or registration of a utility model or design, are reserved. Release 3.00.00

Änderungen vorbehalten
 Subject to change without prior notice