

SIEMENS

7XV5655-0BB00

Manual

C53000-G1176-C175-3

Application Instructions

Serial Modem

Modem for transmission of serial data or protocols
from devices with an RS232, RS485 or FO interface via Ethernet



CONTENTS

General Information	3
Application	8
Description of Interfaces, DIP Switches and Displays	9
Mounting and Commissioning.....	9
Practical Safety Information	9
Preparing the Operating PC or Service Notebook	9
The Configuration Tool	9
Optimising Data Transfer	9
Control Commands.....	9
Description of AT Commands	9
Overview of Registers.....	9
Description of Registers.....	9
Result Codes	9
Optimising Data Transfer	9
Setting Up Password Protection	9
Selecting a Password-Protected Serial Modem.....	9
Valid IP Addresses for Call Accept	9
Pin Assignment.....	9
Technical Data.....	9
Dimensions	9
Ordering Information	9

General Information

This manual contains the information that is necessary for proper and safe operation of the products described. This manual is intended for technically qualified personnel having received special training in, or having special knowledge of protection, measurement and control engineering, hereinafter called automation engineering. The knowledge and correct application of the warnings and instructions contained in this manual are prerequisites to safe installation and commissioning of this product, as well as to proper and safe operation and maintenance. Only qualified personnel as defined overleaf have the special knowledge required for correct interpretation of the general safety information and warnings given in this manual, and for their application to the task in hand. This manual is included in the scope of delivery. For reasons of clarity, however, it does not purport to contain every detail of all versions of the product described, nor can it deal with all possible cases of erection, operation or maintenance. If further information is desired or if special problems arise that are not treated adequately in this document, it is possible to obtain additional details from your local Siemens office or from the addresses stated on the back of this manual.

We should also like to point out that the contents of this product documentation are not part of any previous or existing agreement or legal relationship, nor are they apt to modify such an agreement or relationship. All obligations incurred by Siemens result from the purchase contract, which also contains the complete and solely applicable warranty conditions. Contractual warranty conditions are neither extended nor restricted by the contents of this document.

Disclaimer of Liability

We have checked the contents of this document and every effort has been made to ensure that the descriptions of both the hardware and software are as accurate as possible. However, since deviations cannot be ruled out entirely, we do not accept liability for complete conformity or for any errors or omissions.

The information given in this document is reviewed regularly and any necessary corrections will be included in subsequent editions. We are grateful for any improvements that you care to suggest.

Subject to technical modifications without notice.

Release 2.00.00

Copyright

Copyright © Siemens AG 2008. All rights reserved.

The reproduction, transmission or use of this document or its contents is not permitted without express written authority.

Offenders will be liable for damages. All rights, including rights created by patent grant or registration of a utility model or design, are reserved.

Registered Trademarks

SIPROTEC, SINAUT, SICAM and DIGSI® are registered trademarks of SIEMENS AG. Other designations in this manual might be trademarks whose use by third parties for their own purposes would infringe the rights of the owner.



Statement of Conformity

This product complies with the directive of the Council of the European Communities in accordance with the laws of the member states relating to electromagnetic compatibility (EMC Council Directive 2004/108/EC) and concerning electrical equipment for use within specified voltage limits (Low Voltage Directive 2006/95/EC).

This conformity has been proven by tests performed according to the Council Directives in agreement with the generic standards EN 61000-6-2 and EN 61000-6-4 (for EMC Directive) and with the standard EN 60255-6 (for Low Voltage Directive) by Siemens AG.

The device is designed and manufactured for application in industrial environments. The product conforms to the international standards of IEC 60255 and the German regulations of VDE 0435.

Instructions and Warnings

The information and warnings in this manual must be observed for your safety and to ensure an appropriate service life of the device.

The following terms and definitions are used:



DANGER

means that death, severe bodily injury or substantial material damage will occur if the appropriate precautions are not taken.



Warning

means that death, severe bodily injury or substantial material damage could occur if the appropriate precautions are not taken.



Caution

indicates that minor bodily injury or material damage could result if appropriate precautions are not taken. This applies in particular to damage on or in the device itself and resulting consequential damage.



Note

contains important information about the product or a part of the document to which special attention is directed.



Warning

The 7XV5655-0BB00 is specifically intended for installation in a switchgear cubicle or distribution box. After installation, the entire area around the terminals must be appropriately covered. Only then is the device sufficiently protected against improper contact with live parts.



Warning!

Hazardous voltages occur in this electrical equipment during operation. Severe personal injury or property damage can result if the device is not handled with the appropriate care.

Only qualified personnel should work on or around this equipment. The personnel must be thoroughly familiar with all warnings and maintenance procedures contained in this manual, as well as the appropriate safety regulations.

Successful and safe operation of the unit is dependent on proper transportation, storage, erection and assembly and the observance of the warnings and instructions of the manual.

In particular, the general installation and safety regulations for work in power current plants (e.g. ANSI, IEC, EN, DIN, or other national and international regulations) must be observed.

Failure to observe these precautions can result in death, personal injury or serious material damage.

Never look into fibre-optic waveguide elements or the ends of the fibres.



Qualified Personnel

For the purposes of this manual and the warnings on the product itself, are persons who are acquainted with the mounting, installation, commissioning and operation of the device and who possess the appropriate qualifications for their task, such as

- training and instruction to energise, de-energise, clear, earth and tag circuits and equipment in accordance with established safety practice.
 - training or instruction in accordance with established safety practice for care and use of certain safety equipment.
 - training in rendering first aid can be considered as qualified personnel.
-

Scope of Supply

- Serial Modem, device for DIN rail mounting
- Gender changer, 9-way, male-male
- CD with manual, configuration tool, and Serial Modem driver
- Installation instructions

Unpacking and Repacking

The devices are factory-packed to meet the requirements of IEC 60255–21.

Unpacking and re-packing must be performed with the usual care, without force and only with the aid of suitable tools. Visually check the device immediately upon arrival for correct mechanical condition.

Please also always follow instructions if they are supplied with the device.

The shipping packaging can be re-used in the same manner for further shipment.

Note that the storage packaging of individual devices is not sufficient for shipping. If other packaging is used, the shock requirements acc. to IEC 60255–21–1 Class II and IEC 60255–21–2 Class 1 must be met.

The device should be stored in the final operating area for a minimum of two hours before the power source is first applied. This gives the device time to acclimatise to the temperature equilibrium, thus avoiding dampness and condensation.

Storage

SIPROTEC® devices and associated parts should be stored in a dry and clean place. The device as well as its replacement modules must be stored within the temperature range, which is –10 °C to +55 °C.

The relative humidity is not allowed to lead to condensation or ice.

To avoid premature ageing of the electrolyte capacitors in the power supply unit, a temperature range of +10 °C to +35 °C (+50 °F to +95 °F) is recommended for storage.

After extended storage, the power supply of the device should be energised, approximately every two years, for one or two days to regenerate the electrolytic capacitors in the power supply unit. This should also be done before the device is put into service.

Application

General Scope of Application

The Serial Modem is designed for operation in industrial areas and substations.

The Serial Modem enables devices with serial interfaces (RS232, RS485, or FO) to convert data to the UDP protocol and to transmit and receive data via a TCP/IP network. This enables devices without dedicated network ports to exchange data via the Ethernet.

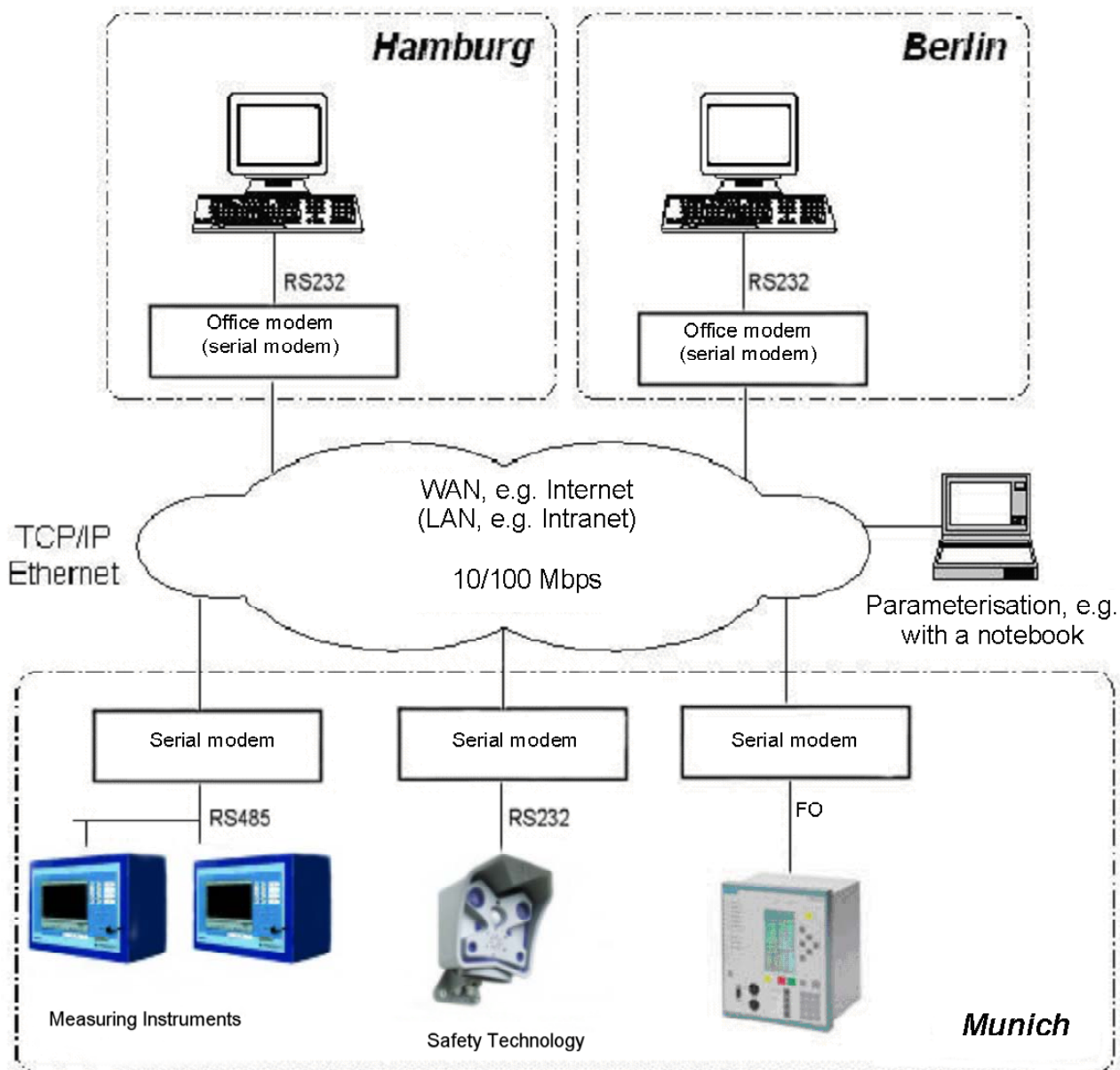

Fig. 1: General scope of application of the Serial Modem

Application in Substations

When using a 7XV5655-0BB00 Serial Modem enables a protection unit to exchange serial data via an Ethernet network. The operating PC can also be linked to this Ethernet network via a 7XV5850 office modem or 7XV5655 Serial Modem.

The protection unit is connected to the Serial Modem via its serial interface. The serial interface types available are RS232 or RS485 (same connector), and FO (fibre optic cable). The serial data is converted to the UDP protocol as useful data in the Serial Modem and transmitted to the office modem via the Ethernet link.

The modem meets the requirements for standard compliance, uninterrupted transmission of serial DIGSI® or IEC 60870-5-103/101 frames via the network by listening into the serial frame traffic and sending the serial IEC telegrams via the Ethernet packed into blocks. Both full-duplex and half-duplex data transmission (RS485) is possible. The serial control lines are not supported. The connection is established between the IP address of the dialling office modem and the IP address of the substation modem and then configured with AT commands via the serial interface before selection of DIGSI®. The substation modem can be configured with password protection and, as an additional security feature, only permits access from certain IP addresses, for example, only from that of the office modem.

The Serial Modem is addressed like a normal phone modem in DIGSI® Remote, except that instead of phone numbers IP addresses are set that can be assigned to each Serial Modem by the network administrator. There is a configuration tool contained in the scope of supply for this purpose.

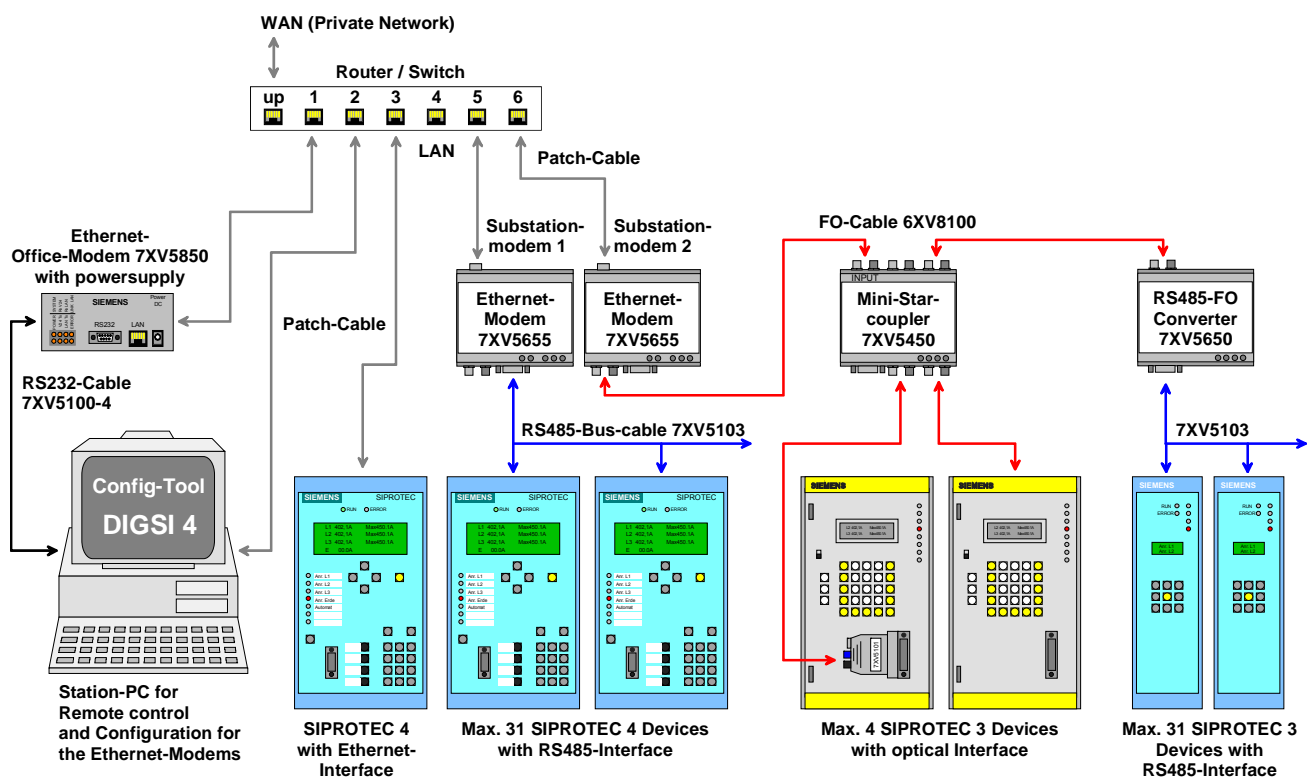

Fig. 2: Application in substations with SIPROTEC® devices

Features

- Protocol detection for VDEW / IEC60870-5-101/103 and DIGSI® protocol (similar to IEC60870-5-103), UDP protocol without error detection and correction
- RS232/RS485 (switchable port) or FO interface for data transfer and modem configuration.
- Serial baudrate and data format to the terminals can be set from 2400 Bd to 115.2 kBd with data formats 8N1, 8N2, 8E1.
- Reset to default values (factory settings) with INIT button: 9600 baud, 8N1
- A 10-Mbit Ethernet interface (10BaseT) for the 10/100 Mbit network.
- DIP switch for RS232/RS485 selection and RS485 bus termination as well as FO idle state
- Enhanced security possible by password protection and IP address selection.
- LED displays for operating voltage and data traffic are located on the front panel
- DIN rail module in the plastic housing with integrated wide-range power supply unit (24 - 250 V DC and 60 - 230 V AC) which provides connection to all conventional substation batteries or AC power systems.
- Protective conductor (PE) connection
- Easy configuration with the configuration tool
- Configuration tool V15 for
 - Microsoft Windows® XP Prof. 32-Bit SP3
 - Microsoft Windows® 7 Prof. 32-Bit SP1
 - Microsoft Windows® 7 Prof. 64-Bit SP1
 - Microsoft Windows® Server 2008 R2 / 64-Bit

Description of Interfaces, DIP Switches and Displays

The Serial Modem has the following connectors:

- A switchable RS232/RS485 interface (9-way SubD male connector)
- FO transmitter and receiver port with ST connectors
- Ethernet connector (10BaseT) for a 10/100 Mbit network
- DIP switches for RS232/RS485 switchover and RS485 termination as well as setting of the FO idle state
- AC/DC power supply and protective conductor (PE) connection via 3-way screw terminals

Communications Interfaces

The RS232/RS485 or FO interfaces are controlled internally by the same processor interface. The electrical interface is selected via the DIP switches. A choice exists between RS232 or RS485; the FO interface always operates in parallel with RS232 or RS485 at the transmitter end and is ORed with RS232/485 at the receiver end, that is, both streams of receive data are unlocked and are received and checked with equal priority. To rule out data collisions, the connected protection units are addressed selectively by DIGSI®. This is done via the address of the protection units.

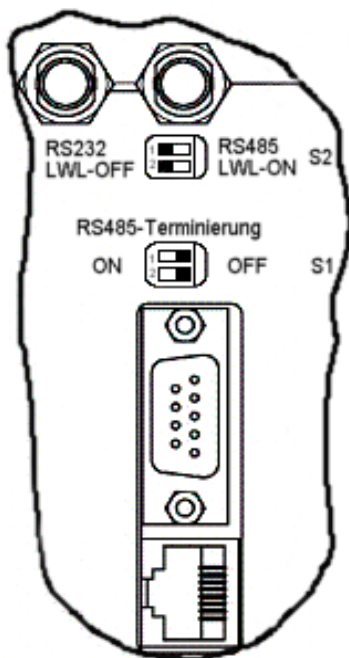

Fig. 3: Connectors and DIP switch positions / RS232

RS232 Interface

The terminal device (protection unit) (e.g. a SIPROTEC® 4 unit) or a further device from the Siemens accessory program (e.g. a 7XV5300 or 7XV5450 star coupler for operating two or more SIPROTEC® devices) can be connected directly to the RS232 port. The data is exchanged between the protection unit and the Serial Modem via this interface. Using a terminal program on the PC / notebook, e.g. "HyperTerminal" from WINDOWS®, it is possible to initialise the Serial Modem with AT commands. To operate the RS232 interface, DIP switch S2-1 must be set to RS232 and DIP switches S1-1+2 to (RS485 termination) OFF. The DIP switch for the FO idle state (S2-2) must be OFF.

Note: The factory settings for all interfaces are 9600 baud / data format 8N1. The settings are automatically adapted to the terminal device's interface by the application (e.g. DIGSI) on connection.

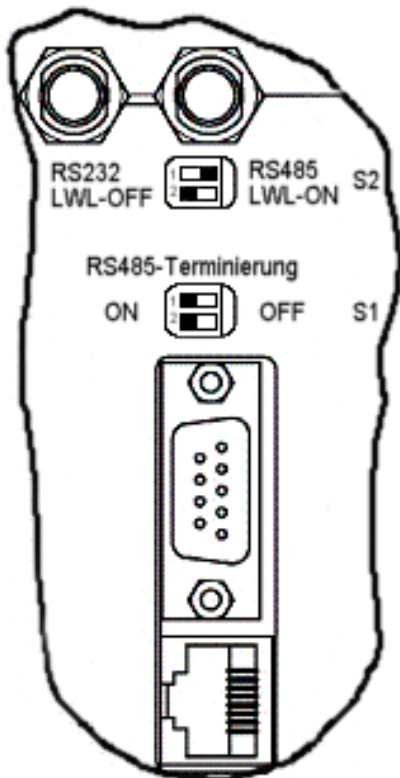

Fig. 4: Connectors and DIP switches / RS485

RS485 Interface

The bus-capable RS485 interface provides a link with increased noise immunity than the RS232 interface. The data transfer rate is identical for both interfaces. The terminal device (e.g. SIPROTEC® 4 device) which is to be applied, or up to 30 further bus-capable SIPROTEC® devices can be connected directly to the RS485 port.

To apply the RS485 interface, DIP switch S2-1 must be set to RS485. The position of DIP switches S1-1+2 is dependent on the requirement of a RS485 termination (the termination is set to ON as the first or last device on the RS485 bus).

The DIP switch for the FO idle state (S2-2) must be OFF (idle state = OFF). For the RS485 mode, “half-duplex” mode it must be set using the configuration tool (see p. 40 Modem Settings)!

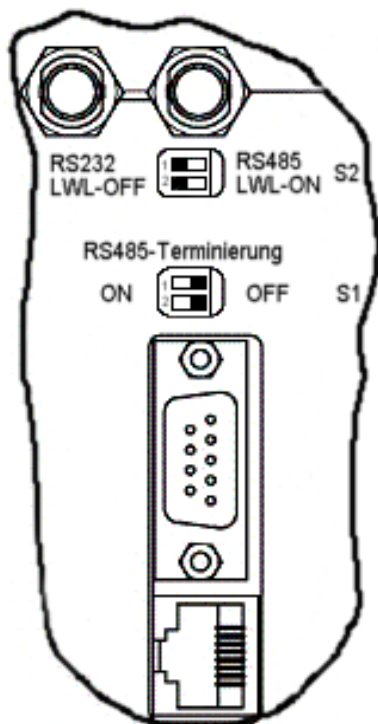

Fig. 5: Connectors and DIP switch positions FO

FO Interface

The FO interface has a transmitter and receiver port with an ST connector. It is a noise-immune link and is used whenever especially high interference levels are to be expected in the operating environment or when equipotential bonding with the terminal device must be avoided. The data transfer rate is that of the RS232 interface. The terminal device (e.g. a SIPROTEC® 4 unit) or a further device from the Siemens accessory program (e.g. 7XV5300 or 7XV5450 star coupler for operating two or more SIPROTEC® devices) can be connected directly to the FO port.

Note: The FO interface is always active with the RS232 interface; the DIP switch (FO-OFF/FO-ON) only sets the idle state.

To use the FO interface, DIP switch S2-2 must be set to match the FO idle state of the communications partner (ON or OFF). DIP switch S2-1 for RS232/485 selection must be set to RS232. DIP switches S1-1 and S1-2 must be set to OFF (see Fig. 5). On SIPROTEC units, the idle state is pre-set to OFF. This is also the factory setting of the Serial Modem.

The 9-way RS232 interface can be used in parallel. If it is not, please cover it with the red protective cover included in the scope of supply !

If the FO interface is not used, it must also be covered with the protective covers included in the scope of supply.

Ethernet Interface (10BaseT)

The Ethernet interface 10BaseT (RJ45) is connected via an Ethernet patch cable (1:1, not cross-over) directly to the output of a router or switch. The data packed in the TCP/IP protocol is transmitted to and received by the Ethernet via this interface.

By using the configuration tool on a PC with an Ethernet interface and a cross-over Ethernet patch cable connected directly to the Serial Modem, it is possible to configure the Serial Modem as well.

The configuration tool is included in the scope of supply.

Auxiliary Voltage

The auxiliary voltage V_{aux} (AC/DC) and the protective earth conductor are connected via three terminals. The wide-range power supply unit has reverse polarity protection (terminals L+ and L- could be exchanged to AC and DC operation) and can for example be used in substations with substation batteries. It features double or reinforced insulation and backs up the auxiliary voltage for >50ms.

DR Contact

The isolated DR contact (device run) is for alarming faulty device states. The device internally monitors the supply voltage and proper functioning of the device.

The contact is open in the normal operating state and closes on faults and auxiliary voltage failure. It is connected via two terminals (GOK 1+2).

INIT Button

The INIT button is for resetting the modem to its factory (default) settings and should only be operated by technically qualified personnel.

It can be used to set a defined baudrate locally for service work. The default baudrate is 9600 8N1. The modem also outputs a reset string with the date and version number of the firmware on its serial interface (RS232 / RS485 / FO).

This reset string can be read by a terminal program (e.g. HyperTerminal in Windows) on a connected PC. The serial interface of the PC must be set to the default baudrate.

After you have operated the INIT button, the baudrate set at the communications partner must also be adjusted, otherwise communication would no longer be possible.

You do not need to use the INIT button if you know the baudrate!

Operating the INIT button does not alter any settings relevant to security such as IP addresses or passwords!

Meaning of Displays

The LEDs indicate the state of the device and have the following meaning:

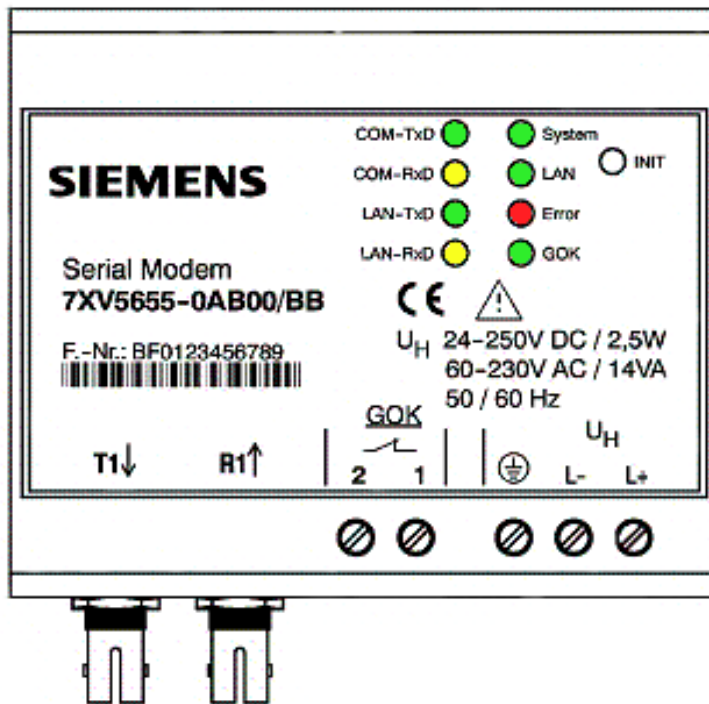

Fig. 6: Connectors, displays (LEDs) and INIT button

- **GOK** Device run: switched on, operating voltage OK device operational
- **System** Slow flashing (approx. 1Hz): no connection to the terminal device
fast flashing (approx. 2Hz) : connection with the terminal device is running (CONNECT)
- **LAN** Physical connection with the network is operational
- **LAN RxD** Receiving data packets from the Ethernet
- **LAN TxD** Transmitting data packets to the Ethernet
- **COM RxD** Receiving data on the serial line from the terminal device (RS232/485 or FO)
- **COM TxD** Transmitting data on the serial line to the terminal device (RS232/485 or FO)
- **ERROR** Error on the serial line (RS232/485 or FO)

Mounting and Commissioning

This section is intended for experienced commissioning personnel. This personnel must be familiar with the commissioning of protection and control systems, with the management of power systems and with the relevant safety rules and standards. Hardware modifications that might have to be made in certain cases are explained. For primary testing, the connected protection unit must be switched on.

General



Warning of improper transport, storage, installation or mounting of the device

Failure to observe these precautions can result in death, personal injury, or substantial material damage.

Problem-free and safe use of this device depends on proper transport, storage, installation and mounting of the device. All warnings and instructions in this manual must be taken into account.

In particular, the general installation and safety regulations for work with power current equipment (e.g. ANSI, IEC, EN, DIN, or other national and international regulations) must be observed.

Mounting Instructions

Devices for DIN rail mounting are only permitted for operation in enclosed housings or cubicles, and may only be mounted in locations that are accessible to qualified personnel only.

The DIN rail housing is intended for mounting on a symmetrical mounting rail according to EN 60715.

For mounting, the device is swung downwards onto the DIN rail, pressed downwards, and snapped on by pressing backwards. The connection is released by lifting the locking element on the underside of the device using a flat screwdriver to loosen it from the mounting rail. The device can then be lifted off the DIN rail in the opposite direction to the snap-on movement.

The data lines for electrical interfaces, e.g. RS232 or RS485, must be encased in screened, earthed cables.

The FO cables must comply with the connection standard of the device (tech. data).

The mounting location should be as vibration-free as possible. The permissible ambient temperature (operating and functional temperature) must be observed (see Technical Data).

Operation outside the functional temperature range or in environments with increased air pollution can lead to malfunctions, failure, and destruction of the device (note the IP class of the device).

Connecting the Device

This describes the connection of all data and power supply lines that are necessary for safe operation.

In the case of electrical installation, follow the rules governing mounting of power current equipment.



Warning

Always use wire end ferrules for stranded conductors.



Warning

Never look into fibre-optic waveguide elements or the ends of the fibres.

Please observe the permissible bending radii of the optical fibre waveguide (manufacturer data).

Bending cables to a smaller radius than the minimum bending radius can destroy the FO fibres.

Auxiliary Power Connection

The contacts for the operating voltage are established via the terminals on top of the device. For the assignment of terminals please refer to the relevant sections of this manual.

The supply voltage of the device must be protected with an external disconnection device including a fuse and identified as such. The fuse selected must be suitable for the cross-section of the connection wires or for the cubicle wiring. (For the fuse value, see the Technical Data.)

Screw terminal connection	Solid or stranded conductors with wire end ferrules for conductor cross-sections 0.25 mm ² to 2.5 mm ² . The dielectric strength of the connecting wires must be at least 300 V AC. Stripping length: up to 8 mm
Minimum cross-section of the wires for auxiliary voltage and earth (ground)	1.5 mm ²
Nominal conductor cross-section	2.5 mm ² , rigid conductor or with wire end ferrule
Tightening torque	0.5 Nm

Connection to the Sub D connector

The Sub D connector must be fastened tightly after connection. The pin assignment is to be found in the relevant sections of this manual (page 41 ff).

Ethernet Connection

The Serial Modem is connected to the network, i.e. a router or switch, by using a patch cable via the RJ45 (10BaseT) connector.

The dielectric strength of the Ethernet cable must be at least 300 V AC.

OR

The Serial Modem is connected directly to the operating PC using a cross-over patch cable via the RJ45 connector.

The "link LAN" LED indicates correct connection with the Ethernet.
If that is not the case, check the network connection or network cable.

Cat5 cables (or better) must be used.

Commissioning

Check whether the operating data match the values on the rating plate. Do not make any changes on the device that are not described in this manual.

Plug in the connecting cable for the RS232/RS485 and fasten it tight or plug in the FO cable and secure it. If you are not using the Sub D connector for RS232/RS485, attach the red cover supplied.

Set the DIP switches for serial mode (RS232 / 485 / FO).

Maintenance and Cleaning

The device is maintenance-free. Use only a dry cloth for cleaning. Never use liquid or aerosol cleaning agents.

Do not use liquids of any kind for cleaning.

Practical Safety Information

As is the case for all electrical equipment, there are some basic safety precautions to be taken. These safety precautions are primarily for your own protection but also prevent damage to the device.

Settings not described in the manual and changes to the device electronics can only be carried out by an authorised vendor.

Read the device manual carefully and keep it close at hand.

Make sure that ...

- The device is always connected to earth (ground)
- the device is never placed near a heating source or the outlet of an air-conditioning unit.
- The device is never exposed to direct sunlight.
- The device never comes into direct contact with liquids of any kind. Never use liquids in the vicinity of the device.
- opening the housing can lead to electric shock and other damage. Never make any changes to the device that are not permitted in this manual. Doing so could damage the device. Any damage caused by unauthorised handling of the device are done at own risk and own cost of repair or replacement.

Make sure that ...

- the rating of the supply voltage corresponds to the specification on the device main plate. If in doubt, contact your supplier.
- the supply voltage is protected against surges and other disturbances.
- the maximum power rating of the connected cables is not exceeded and conductors have the required minimum cross-section.
- all connected cables are protected against damage.
- a damaged supply voltage cable is replaced immediately.
- the line-side fuse is removed before cleaning the device to ensure complete disconnection from the power source, and precautions are taken to prevent unintentional reconnection.

Preparing the Operating PC or Service Notebook

Before commissioning the Serial Modem, the following precautions must be taken on the on the operating PC or service Notebook.

This requires the following operating systems

Windows® XP Prof. 32-Bit SP3

Windows® 7 Prof. 32-Bit SP1

Windows® 7 Prof. 64-Bit SP1

Windows® Server 2008 R2 / 64-Bit

These Windows Operating Systems were used to test the installation as well as the full scope of functionalities of the device.

Installation of the Modem Driver

To operate the Serial Modem in a WINDOWS® application requiring a dial-up link, the modem driver must first be installed in the WINDOWS® Control Panel.

The modem-driver „**ipEtherModem_Setup**“ for the serial modem contains two files “**ipEtherModem.inf**“ and ”**ipethermodem.cat**“.

Installing the Configuration Software V15

For the installation of the configuration tool corresponding set-up files are available for the various WINDOWS®-Operating Systems.

“ipEther.config.Setup_x86.exe” for Windows® XP SP3 and 7 SP1 32-Bit

“ipEther.config.Setup_x64.exe” for Windows® 7 SP1 64-Bit and Server 2008 R2

There are two ways of configuring the Serial Modem using the configuration tool via the Ethernet interface.

1. The modem is connected directly to the operating PC/Notebook using a cross-over patch cable. After the configuration tool has been started, the connected Serial Modem is automatically located and can be configured.
2. The Serial Modem is connected with a patch cable to a switch in an existing network, to which the operating PC/Notebook is connected as well. After the configuration tool has been started, all connected Serial Modems are located automatically and can be configured. To configure Serial Modems that are located in another network segment (e.g. behind a router), they must be searched for in the network by manually entering the IP address. The IP-addresses of these modems cannot be changed.

Configuring the Ethernet Interface of the Operating PC

For the operating PC to be able to communicate with the Serial Modem, the Ethernet interface of the operating PC/Notebook must be configured accordingly.

Changing the settings of the Serial Modem with a Terminal Program

The terminal program (e.g. "HyperTerminal" in WINDOWS® or the program „DIGSI Terminal“ for WINDOWS® XP and WINDOWS® 7) is required to make all settings relevant to security such as password protection and the valid IP addresses for call acceptance. These settings can only be activated or changed via the local RS232 interface using a terminal program, i.e. not via the Ethernet and also not locally via the Ethernet interface.

Installing the Modem Driver

Before you can use the Serial Modem in a WINDOWS® application, the modem driver must first be installed in the WINDOWS® Control Panel.

The modem driver may be found on the CD/DVD included, as well as in the Internet under: www.siemens.com/siprotec

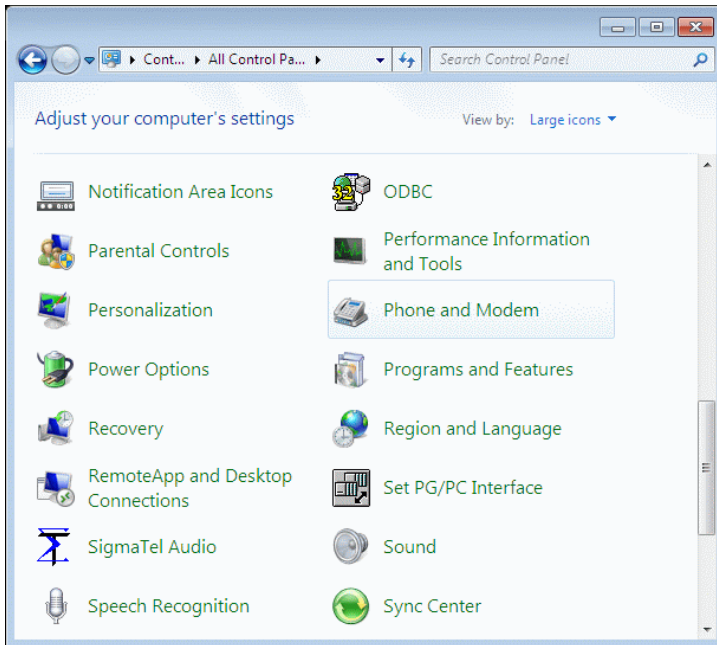

In the Control Panel, select **"Phone and Modem"** by double-clicking the icon.

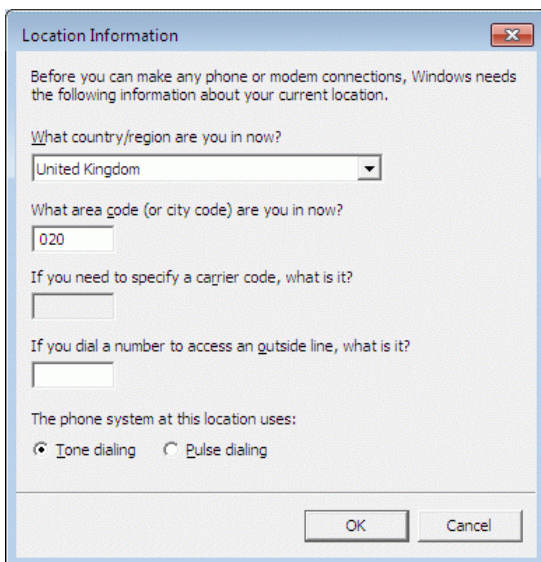

At least the **Country/Region** and the **city code** must be entered in the window **Location Information**.

Continue with **OK**.

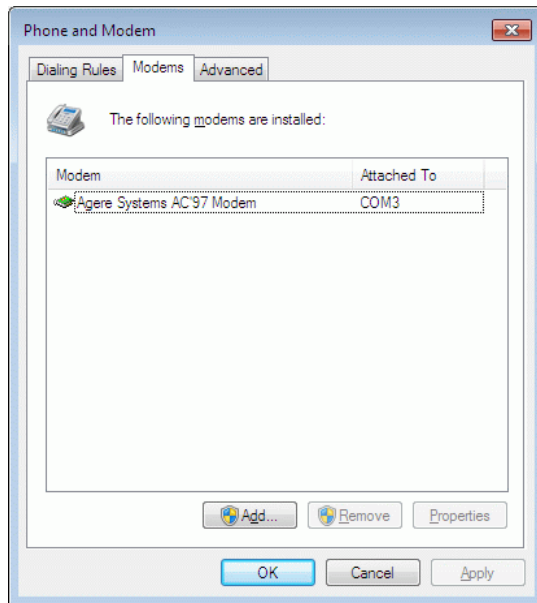

Add... installs a new modem driver in in WINDOWS®.

If no modem driver has been installed yet, WINDOWS® automatically offers an installation window.

Continue with **OK**.

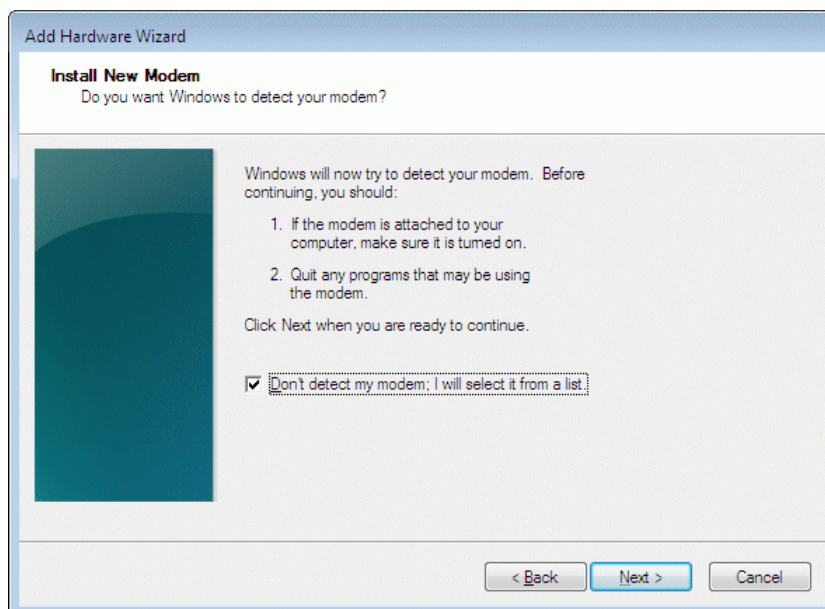

The modem must be selected manually.

This is done by placing a checkmark in the

Don't detect my modem; I will select it from a list checkbox.

Click **Next >**.

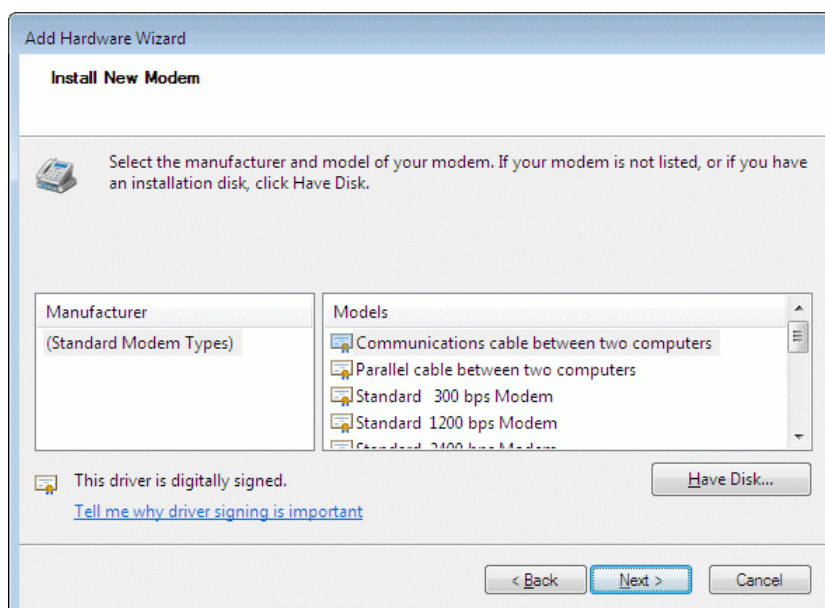

Install a new modem from **Have Disk...**

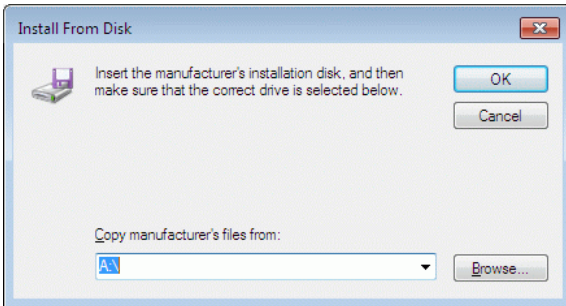

Select the correct drive (**Copy manufacturer's files from**) and go to the driver disk with the modem driver with **Browse...**

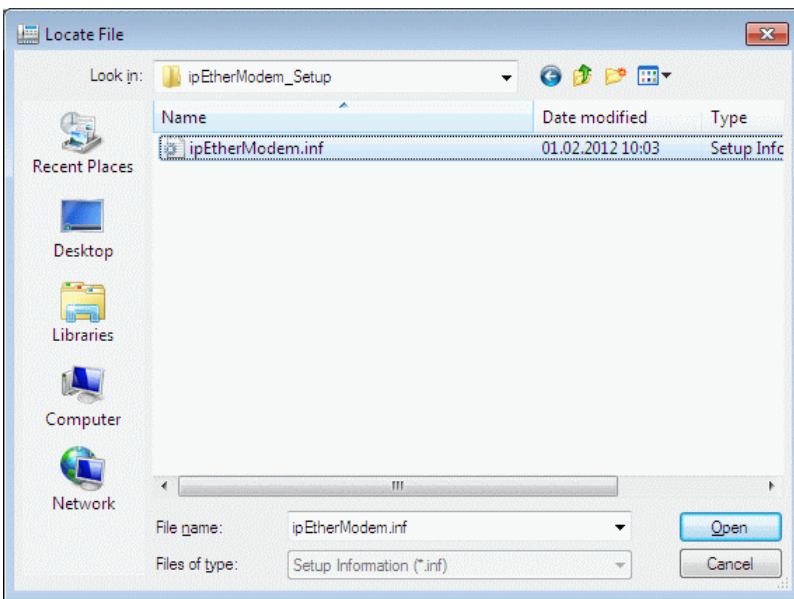

Select the path in which the modem driver **ipEtherModem.inf** is located.

Continue with **Open**

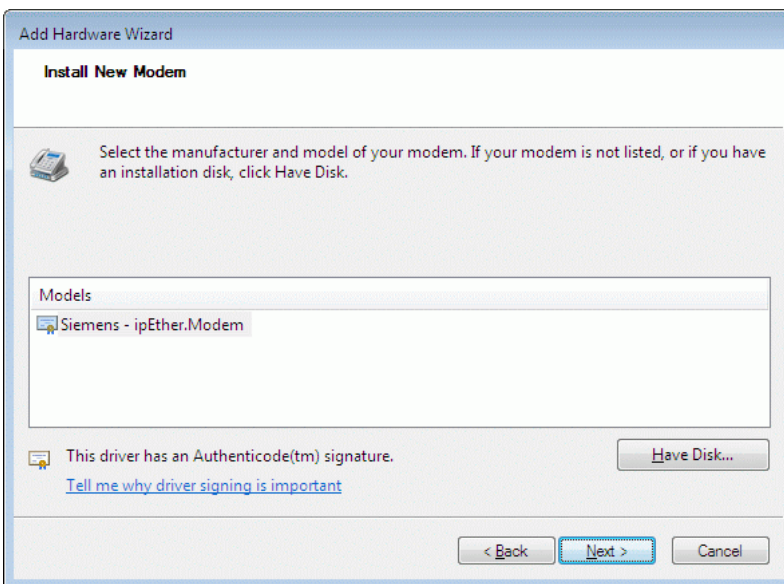

Select modem model

Siemens – ipEtherModem

This driver carries a digital signature from WINDOWS®.

Should a warning nevertheless be displayed, it can be ignored.

Continue with **Next >**

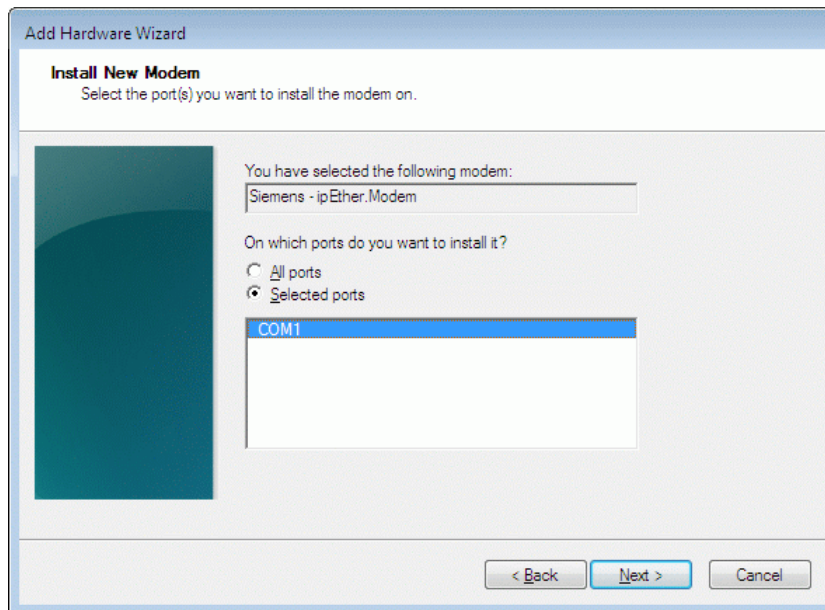

Select the serial port, e.g.
COM1
to which the Serial Modem
will later be connected.

Continue with **Next >**

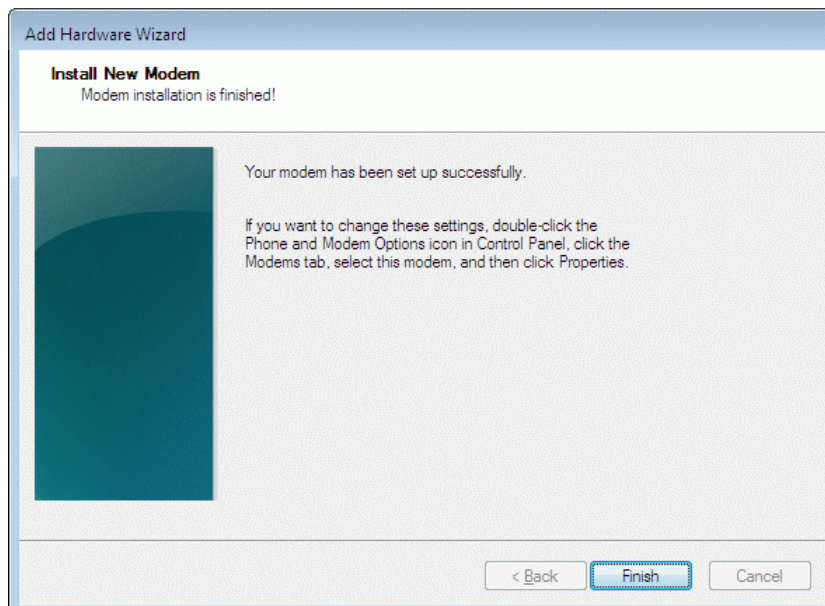

Installation is completed
with **Finish**

After installing the modem driver, the PC must be re-started.

Descriptions of the settings of the serial modem driver

The (basic-) settings of the modem may be applied any time.

For this purpose double-click on the icon „**Phone- and Modem**“ under “**System Control.**”

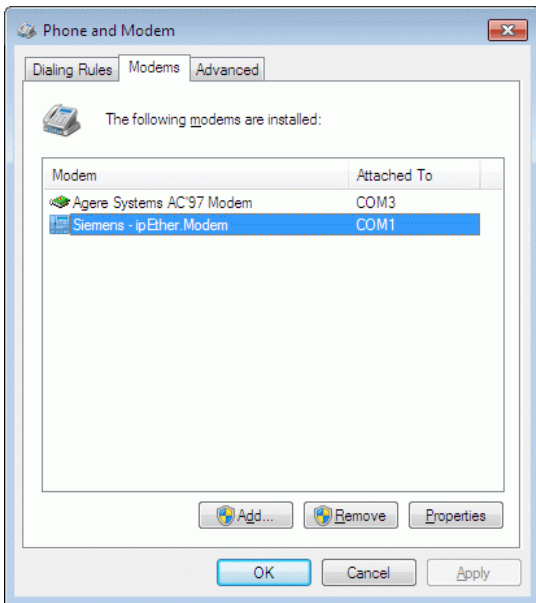

Overview of the installed modem drivers in WINDOWS®.

With **Properties**, you can check settings of the selected modem and change them.

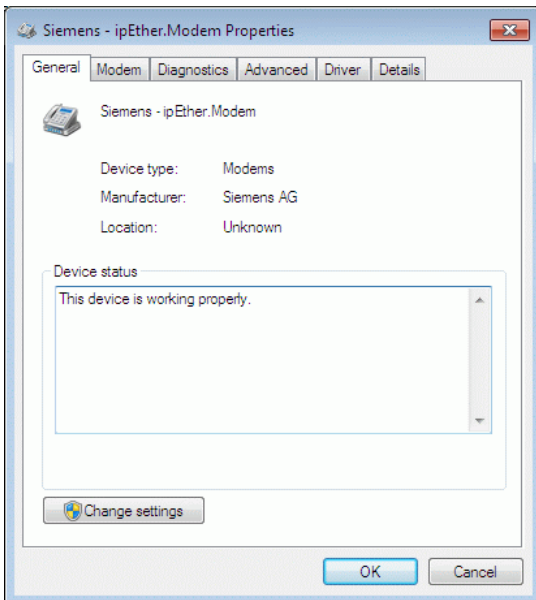

To change the modem settings, select **Change settings**.

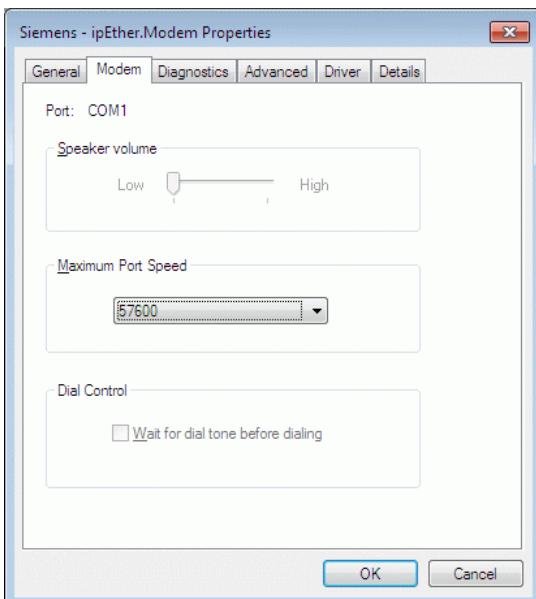

Here you can set the maximum baudrate to the end device.

Note: For communication with SIPROTEC®-protection devices, a maximum baud-rate of 57600 must be set.

The Serial Modem that is connected can be displayed under **Diagnostics** with its baudrate (default 9600 8N1).

Configuring the LAN Interface of the Operating PC

There are two ways of configuring the Serial Modem on a PC using the configuration tool via its Ethernet interface:

Direct PC ↔ modem LAN connection with "cross-over patch cable"

The modem is connected directly to the operating PC using a cross-over patch cable. The LAN interface of the computer must be assigned a fixed IP address for this purpose.

Note: If the computer is operated in a company LAN, a variable IP address is usually assigned by the server (see next section). If the Serial Modem is to be configured directly via the cross-over cable with this computer, a fixed IP address must be assigned to this computer for this time.



Select the appropriate "Local area connection" under "Network connections".

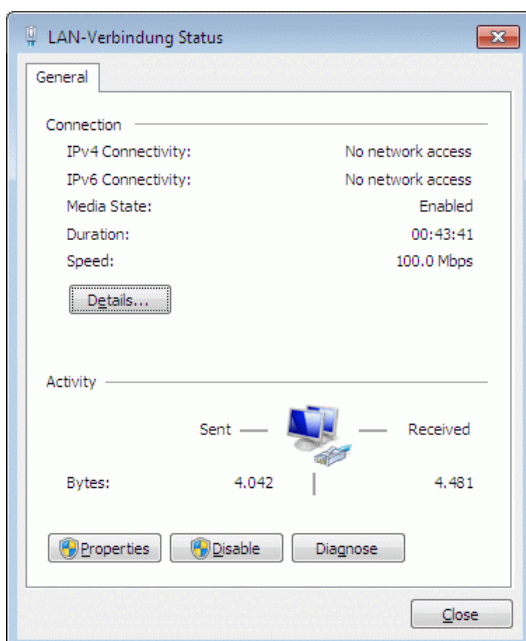

In the "Local area connection status" window, click the

"Properties"

button to switch to the local area connection settings.

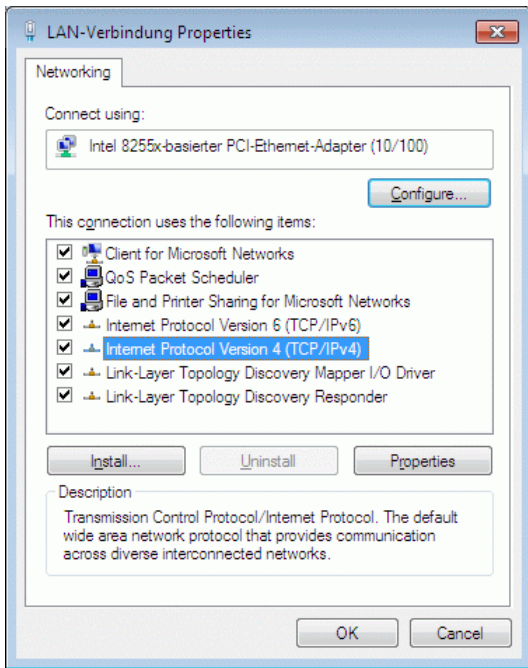

The IP address is set under **"Internet Protocol Version (TCP/IPvx)"** by clicking the **"Properties"** button.

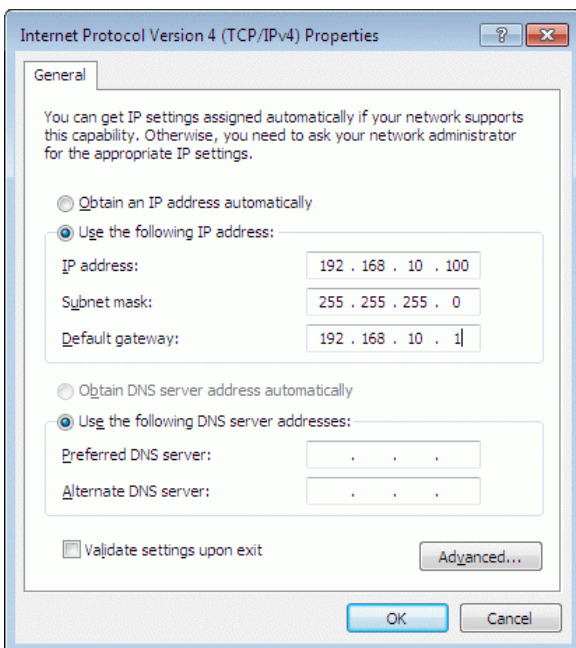

To assign a fixed IP address, select **"Use the following IP address"**

Under **"IP address:"**, enter a free IP address for private networks, e.g. **192.168.10.100**

Under **"Subnet mask:"** the associated subnet mask **255.255.255.0**

Under **"Default gateway:"** the default gateway address, e.g. **192.168.10.1**

Finish off with **"OK"**.

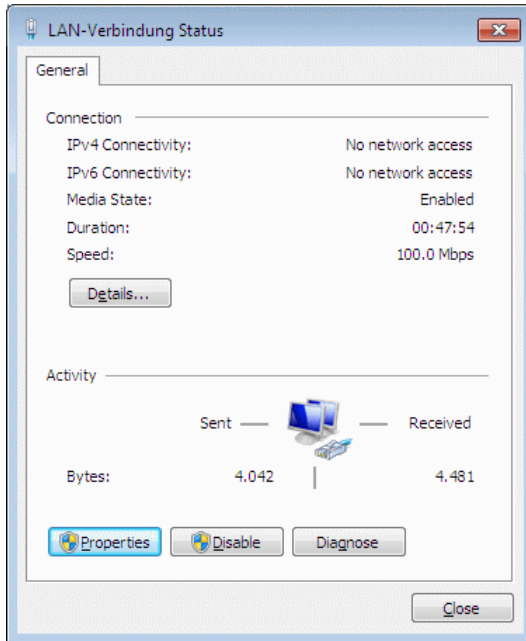

In the "Local area connection status" window, go to

"Support"

if you want to check the settings of the LAN interface.

Close the window again with the

"Close"

button.

After you have started the configuration tool, the connected modem is found automatically and can be configured (see Section "Configuration tool").

PC ↔ modem LAN connection in an existing network

The modem is connected with a patch cable (not cross-over) to a hub or switch in an existing network to which the operating PC is also connected. The PC usually obtains a free IP address from the server.

The LAN connection of the operating PC to the network can be checked as described in the previous section.

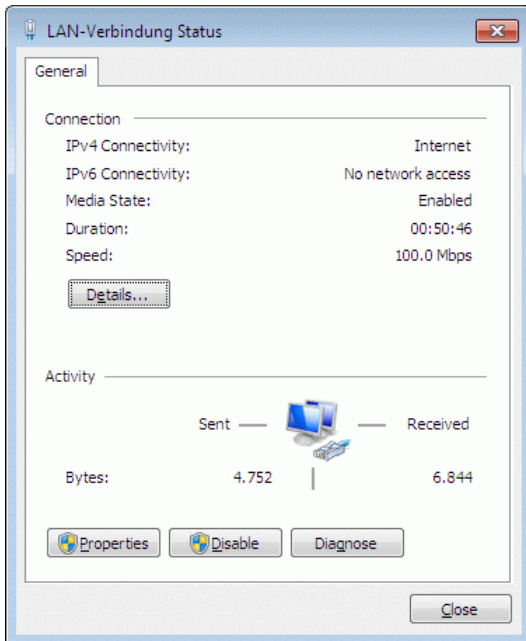

In the "Local area connection status" window, go to

"General"

to display the status of the network connection.

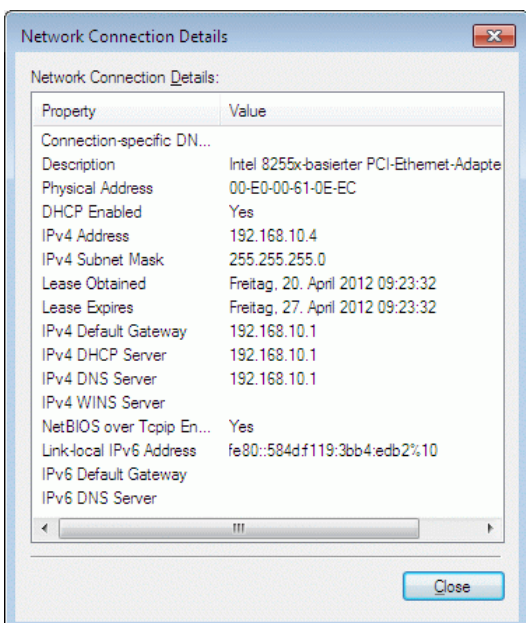

Under **"Details..."** you can look at the settings assigned to the connection.

Here, the network addresses are automatically assigned by a DHCP server in the network.

After you have started the configuration tool, all modems connected in the same network segment are found automatically and can be configured (see Section "Configuration tool")

Using "HyperTerminal" via the Serial Interface of a PC

This terminal program is supplied as a standard feature of the operating system WINDOWS® XP.

Start HyperTerminal under:

"Start → Programs → Accessories → Communications → HyperTerminal"

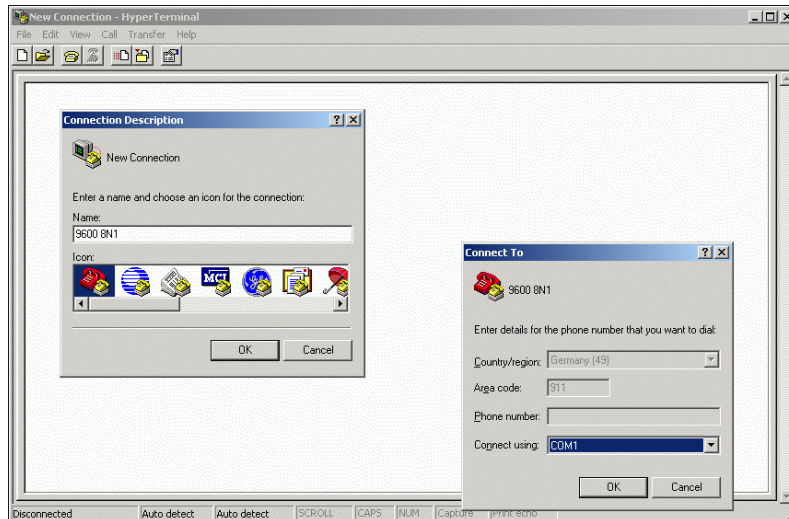

Enter a name for the new connection, e.g. 9600 8N1.

The connection can be saved on exiting.

Assign a PC interface to the connection, e.g. COM1.

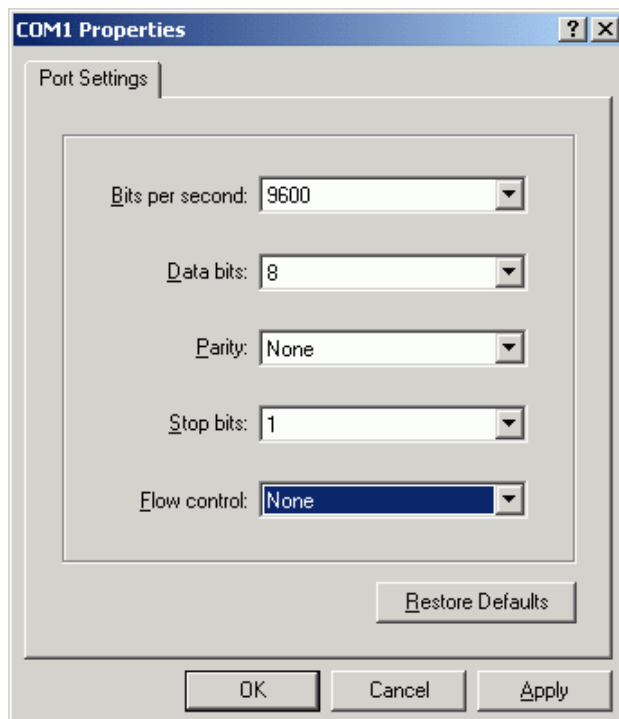

For a **new Serial Modem**, select the settings

9600 bits per second,
8 data bits,
none for parity,
1 stop bit and
none for flow control

Continue with

OK

Note: The Serial Modem can only be set via the serial interface in the currently set baudrate and data format. If these settings were changed, the connection settings in HyperTerminal would have to be adjusted.

It is advisable to note down these settings to avoid any problems accessing the modem later.

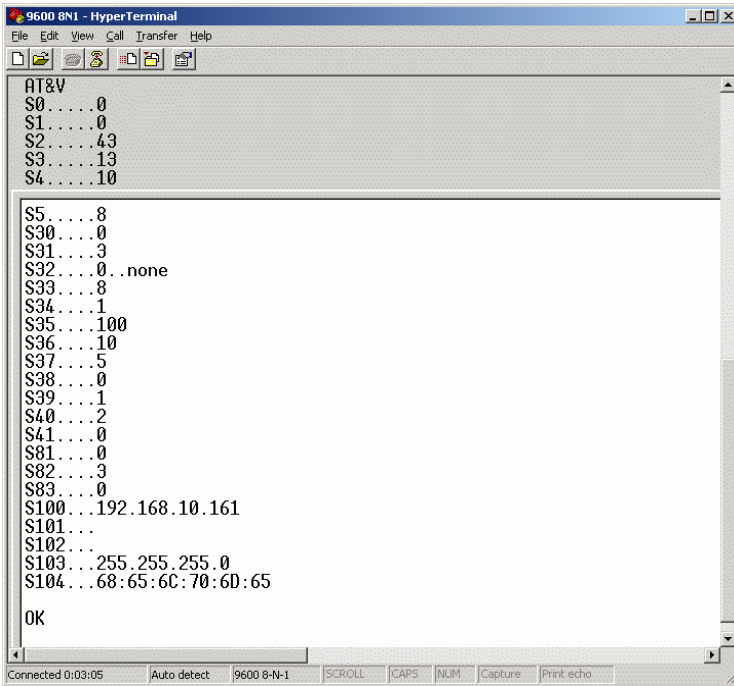

The screenshot shows a HyperTerminal window titled "9600 8N1 - HyperTerminal". The window contains the following text:

```
AT&V
S0....0
S1....0
S2....43
S3....13
S4....10

S5....8
S30....0
S31....3
S32....0..none
S33....8
S34....1
S35....100
S36....10
S37....5
S38....0
S39....1
S40....2
S41....0
S81....0
S82....3
S83....0
S100...192.168.10.161
S101...
S102...
S103...255.255.255.0
S104...68:65:6C:70:6D:65

OK
```

At the bottom of the window, there is a status bar with the following information: "Connected 0:03:05", "Auto detect", "9600 8-N-1", "SCROLL", "CAPS", "NUM", "Capture", and "Print echo".

If the Serial Modem is connected to the PC, it is possible to **read out** the current settings with the **AT&V** command.

These settings can be changed by entering "**Hayes commands**".

See the section on "Control Commands" for further information.

For Windows XP and WINDOWS 7 the terminal program “**DIGSI Terminal**“ is available on the included CD/DVD as well as in the Internet under www.siemens.com/siprotec.

After starting of the program, this is self-explanatory.

- select COM-Port
- set baud-rate as well as the data format
- press the button “connect

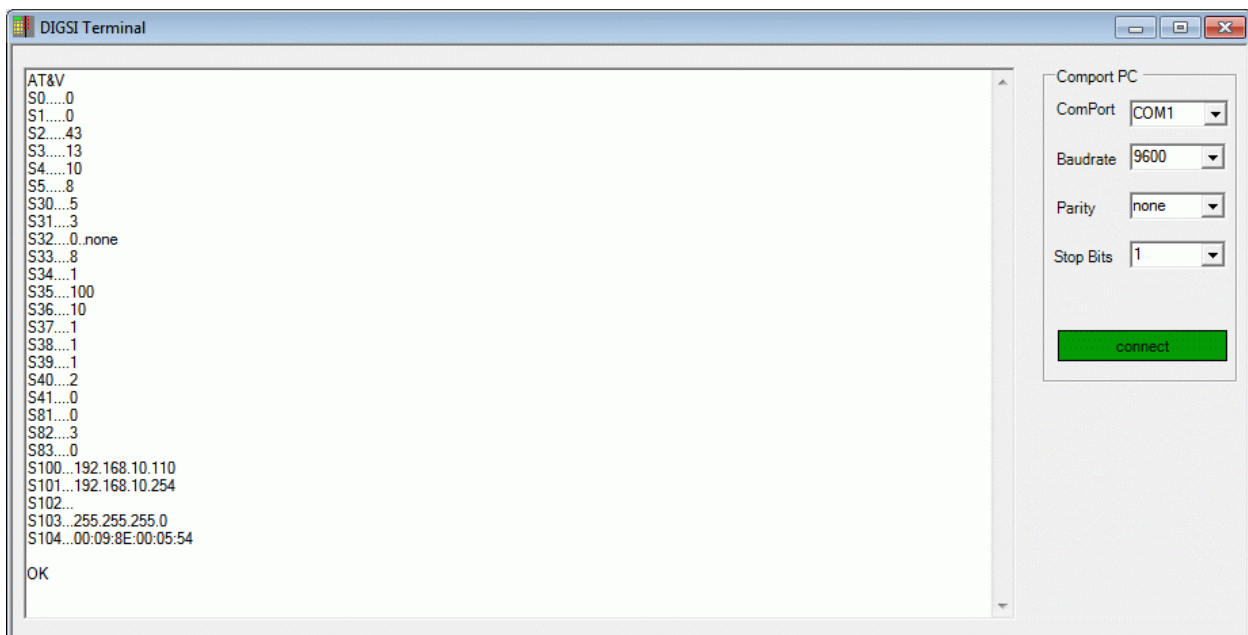
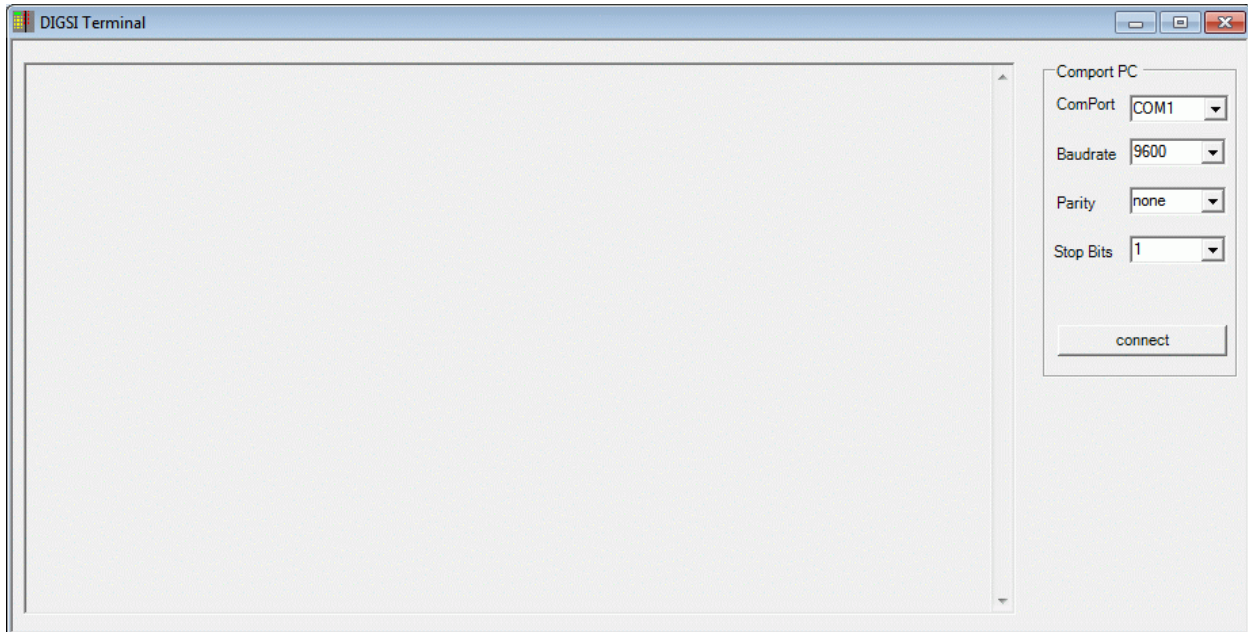

Out-put of the modem settings after entering AT&V.

Note: Entered characters are not displayed. To enable this, the “Echo” has to be activated with the command “ATE1“ on the connected device such as for example a modem.

The Configuration Tool

Installation of the configuration tool V15

Pre-requisite is one of the following operating systems:

- Microsoft Windows® XP Prof. 32-Bit SP3
- Microsoft Windows® 7 Prof. 32-Bit SP1
- Microsoft Windows® 7 Prof. 64-Bit SP1
- Microsoft Windows® Server 2008 R2 / 64-Bit

The configuration tool may be found on the included CD/DVD as well as in the Internet under www.siemens.com/siprotec.

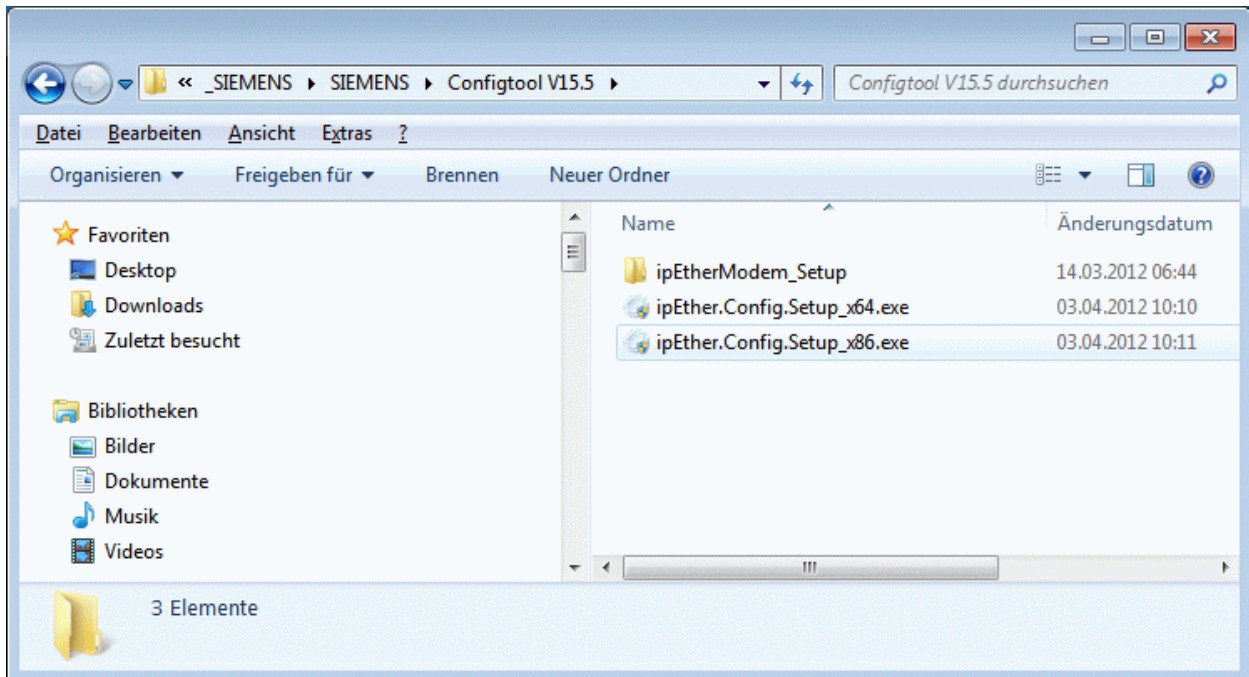

- Selection of the set-up filing directory in the WINDOWS® Explorer
- Start of the installation on the operating PC by double-clicking on the file :
- “ipEther.config.Setup_x86.exe” for Windows® XP SP3 and 7 SP1 32-Bit
- “ipEther.config.Setup_x64.exe” for Windows® 7 SP1 64-Bit and Server 2008 R2.

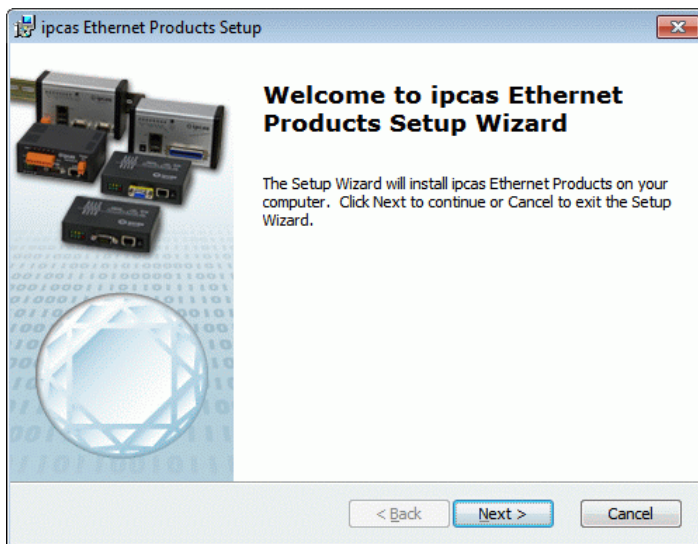

Continue the installation with
“Next >”

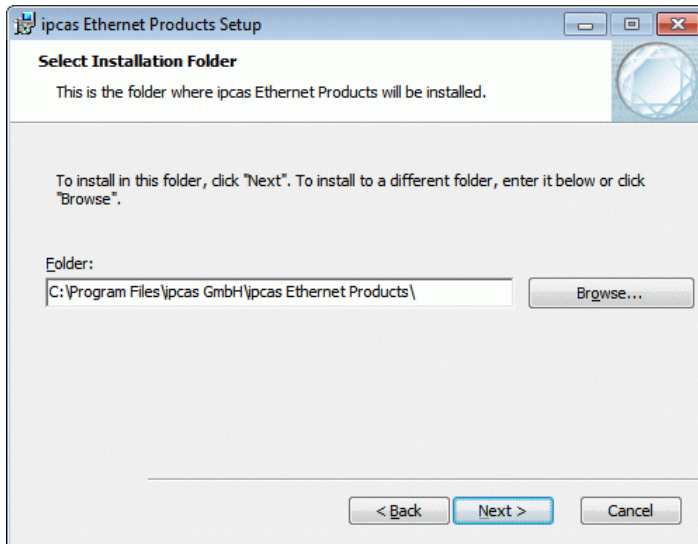

With “**Browse...**” the pre-set installation path can be altered.

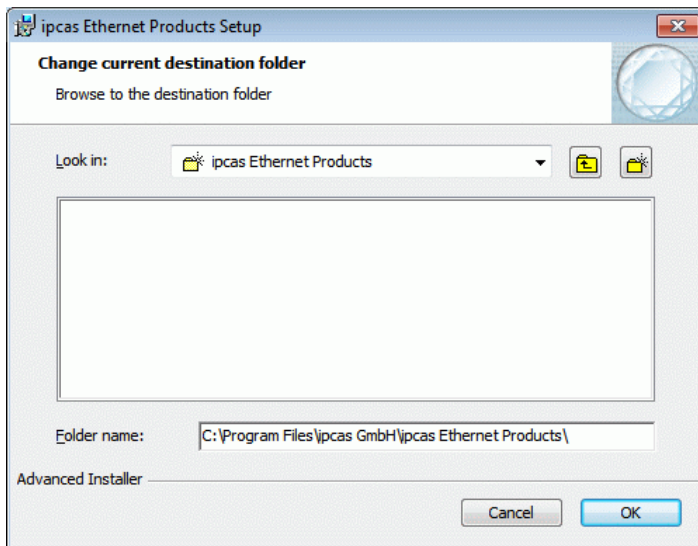

Select the installation folder here or create a new folder

Continue with “**OK**”

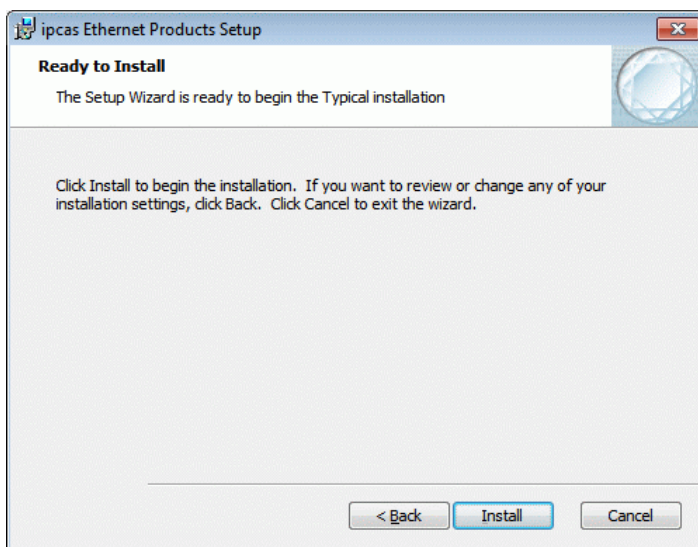

By selecting “**Install**” the configuration tool is installed on the operating PC.

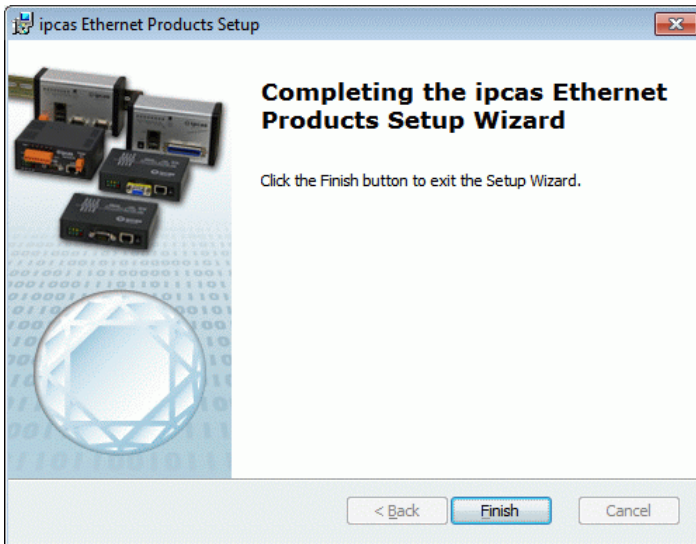

When this window is displayed the installation has been completed successfully and the process is completed with **“Finish”**.

The configuration tool may be started on the desktop of the PC/Notebook with the icon **“Configuration Utility”**.

De-installation of the configuration tool

The de-installation of the program may be carried out via **WINDOWS® System Control Panel-> Programs and Functions-> ipcás Ethernet Products**. Alternatively it may be done by starting the installation directory, ipEther.config.Setup_xyy.exe.

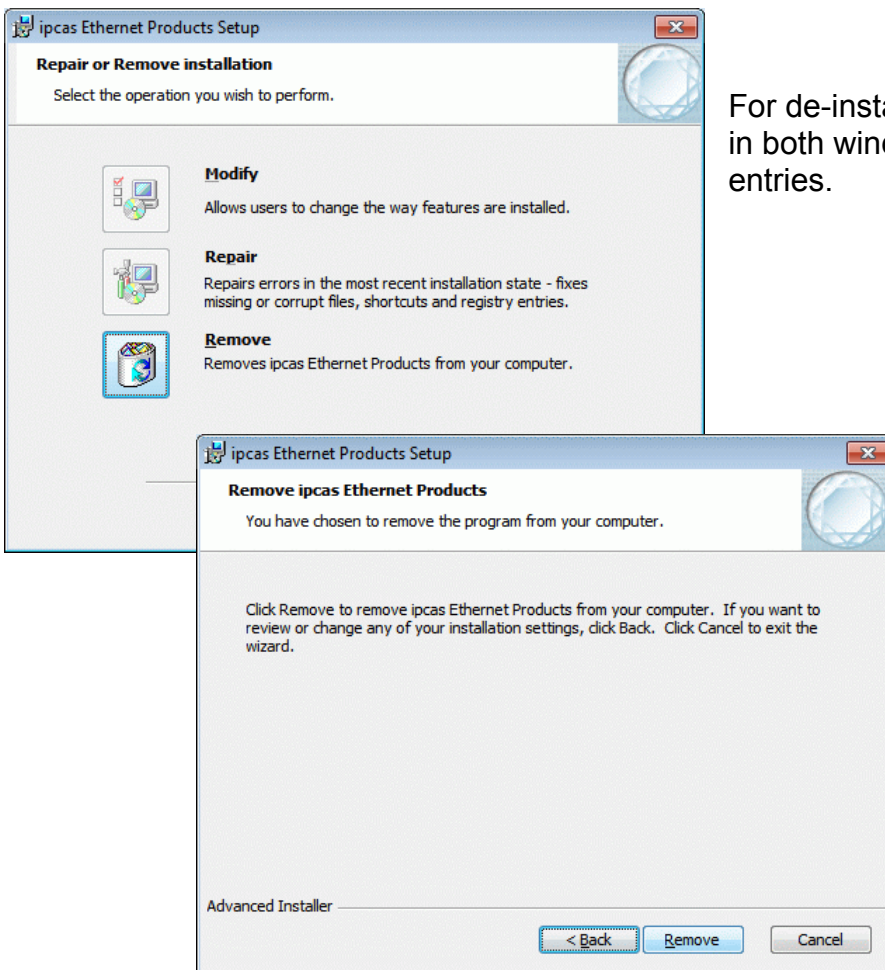

For de-installation select **„Remove“** in both windows and confirm the entries.

Configuring the Serial Modem with the Configuration Tool

The configuration tool provides a practical way of making "basic settings" such as modem name, IP address and baudrate of the Serial Modem.

For this purpose, the configuration tool is started and finds all Serial Modems in the same network segment which it then lists in a table.

All settings can also be made with AT commands via the serial interface. Password protection and protected call acceptance are only possible via this interface.

Overview Window

The configuration program finds all devices in its own network segment, even those without a valid IP address.

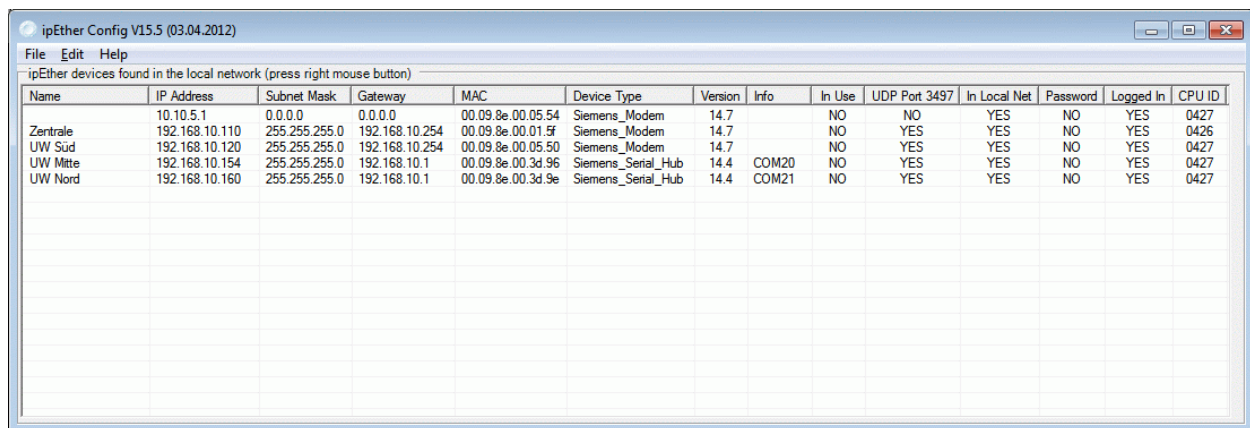

ipEther devices found in the local network (press right mouse button)														
Name	IP Address	Subnet Mask	Gateway	MAC	Device Type	Version	Info	In Use	UDP Port 3497	In Local Net	Password	Logged In	CPU ID	
Zentrale	10.10.5.1	0.0.0.0	0.0.0.0	00.09.8e.00.05.54	Siemens_Modem	14.7		NO	NO	YES	NO	YES	0427	
UW Süd	192.168.10.110	255.255.255.0	192.168.10.254	00.09.8e.00.01.5f	Siemens_Modem	14.7		NO	YES	YES	NO	YES	0426	
UW Mitte	192.168.10.120	255.255.255.0	192.168.10.254	00.09.8e.00.05.50	Siemens_Modem	14.7		NO	YES	YES	NO	YES	0427	
UW Nord	192.168.10.154	255.255.255.0	192.168.10.1	00.09.8e.00.3d.96	Siemens_Serial_Hub	14.4	COM20	NO	YES	YES	NO	YES	0427	
	192.168.10.160	255.255.255.0	192.168.10.1	00.09.8e.00.3d.9e	Siemens_Serial_Hub	14.4	COM21	NO	YES	YES	NO	YES	0427	

Clicking on the column header in the overview, e.g. "IP address", sorts the devices in ascending or descending order of the items in that column.

Items in the Overview Window:

Name	Modem name for better identification by means of a self-explanatory text.
IP Address	Current IP address
Subnet Mask	Current Subnet Mask
Gateway	Current Gateway
MAC	Worldwide unique MAC address
Device Type	Device Type
Version	Current firmware version
Info	Currently configured COM port (not available for Serial Modems)
In Use	If the entry is "YES", the device is in connection mode and it is not possible to make changes to the settings.
UDP-Port 3497	If this entry is "NO", the device will no longer be found. It is not connected, deactivated, or is behind a router that is blocking the UDP port 3497.

in local Net	If this entry is "NO", the device is not in the local network segment. If the device is installed behind a router, the IP address cannot be changed. This prevents the device from being accessed unintentionally.
Password	If this entry is "YES", the device is password-protected and the password must be entered before configuration (by right-clicking on "login"). <i>If the password is forgotten, the device must be submitted again (see last page).</i>
Logged in	If this entry is "NO", the password has to be entered before configuration (by right-clicking "login").
CPU-ID	Internal device ID (not relevant for users)

General Settings

When the Serial Modem is delivered, no valid IP address has been set yet. The default address is **10.10.5.1**.

A unique IP address must first be assigned to each device.

To set the IP address in the Serial Modem, the device must be connected in the same network segment. Otherwise, the device should be connected to the operating PC using a "cross-over" patch cable.

If the Serial Modem is integrated into a DHCP network, i.e. the available IP addresses are assigned automatically, the network administrator on the DHCP server **must** assign a **fixed IP address** for the Serial Modem.

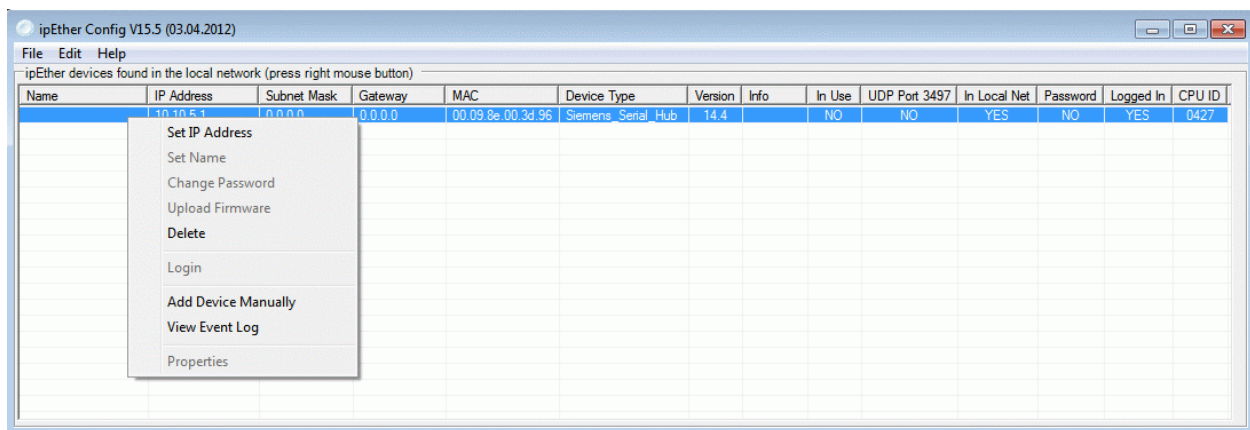

Right-clicking the device entry in the overview window displays a dialog box in which further actions can be performed.

Set IP Address

Enter a fixed IP address, Subnet-Mask and Default-Gateway for operation of the Serial Modems in a network. If the allocated IP-address and the Subnet-Mask are not compatible the properties can not be changed any more. In such an event please change the settings.

Set Device Name

Enter the name of the Serial Modem for a more transparent overview in the table.

Change Password

Before a password can be assigned or altered, the old password has to be entered. Then enter the desired new password twice.

No password has been set on delivery, which means that the space "Password" remains unfilled with the first change.

If the password protection is to be deactivated, the old password is entered and the empty spaces of the „New Password“ are confirmed with "Return".

Upload Firmware

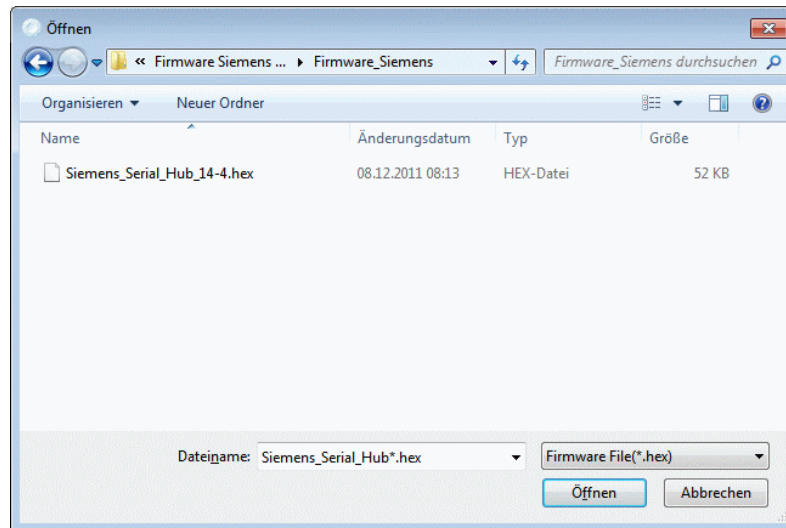

Locate the new firmware version and import it with "Open" or by double-clicking.
The firmware update re-sets the Serial Modem to its factory settings (default settings). Passwords are not re-set.

If the message: "Can't upload Firmware. See Logging" appears during a firmware update, please repeat the upload until the message: "device is up again" appears.

The configuration tool may be found on the included CD/DVD as well as in the Internet under www.siemens.com/siprotec

Delete

Currently marked entry is deleted.

Login

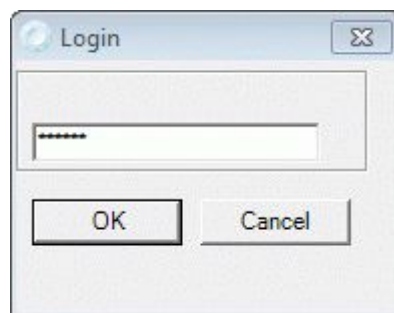

If the device is password-protected (Password required = "True"), the password must be entered before configuration.

Add Device Manually

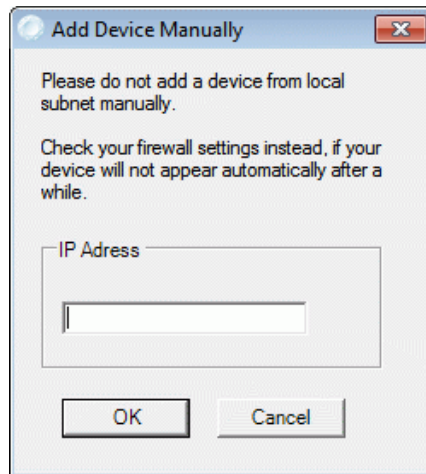

If the Serial Modem is connected behind a router, it is not located automatically but must then be added manually ("Add Device manually"). This is done by entering its IP address in the required space. If the device can be accessed at this address, it is imported into the list.

Note: If the device is installed behind a router, the IP address cannot be changed. This prevents the device from becoming unaccessible by mistake.

View Event Log

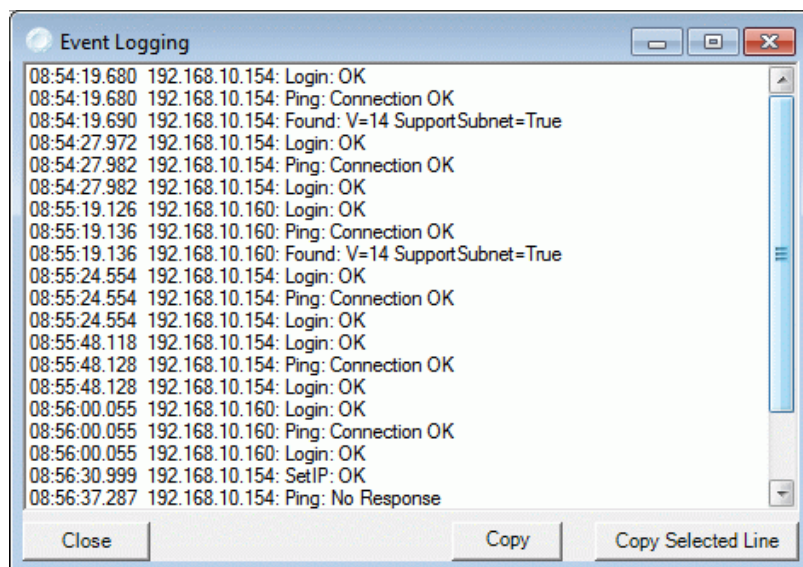

View current log-file (internal trace)

Properties

Type-specific configuration user surface
For more information, see the relevant chapters in this manual.

Properties

If the settings (Properties) are to be carried out or changed under Windows 7, the Configuration tool must be opened as Administrator. If the Tool has been started without administrative rights this is displayed in the header.

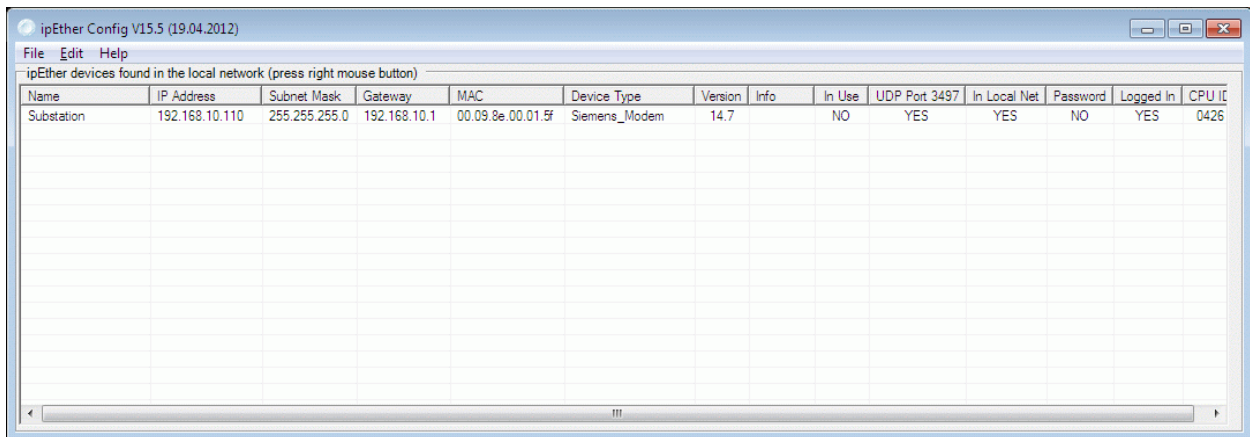

Double-clicking the device entry in the overview window displays a dialog box in which further settings can be made.

A detailed dialog box consisting of six setting tab cards opens:

TCP/IP Settings

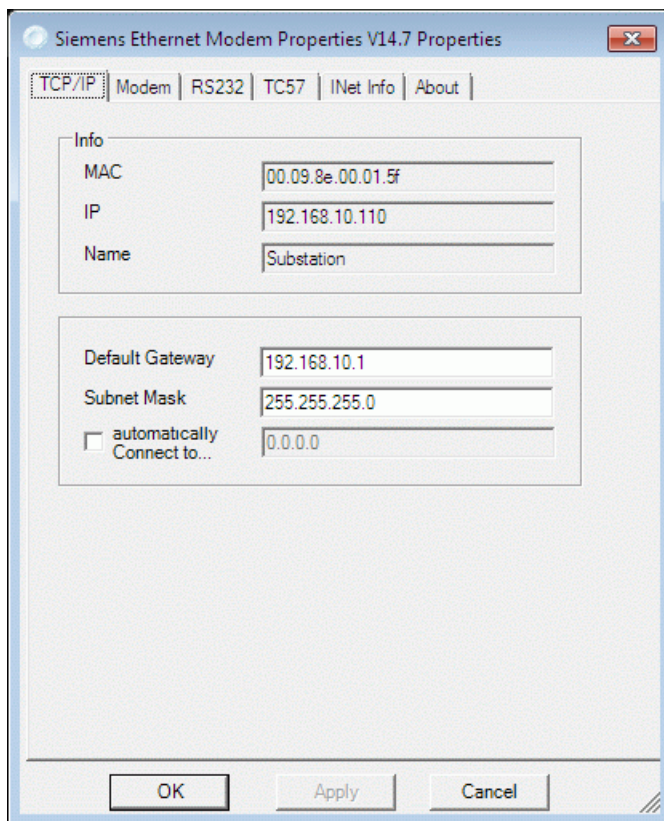

"Info" displays the

MAC address,
IP address and the
Device name

Further network settings such as

Default Gateway, and
Subnet Mask

are determined by the network and can be entered here.

By clicking

Automatically Connect to ... (leased line)

you can set up a leased line to another Serial Modem with the IP address entered.

After a connection break-off there is an automatic attempt at restoring the connection.

Modem Settings

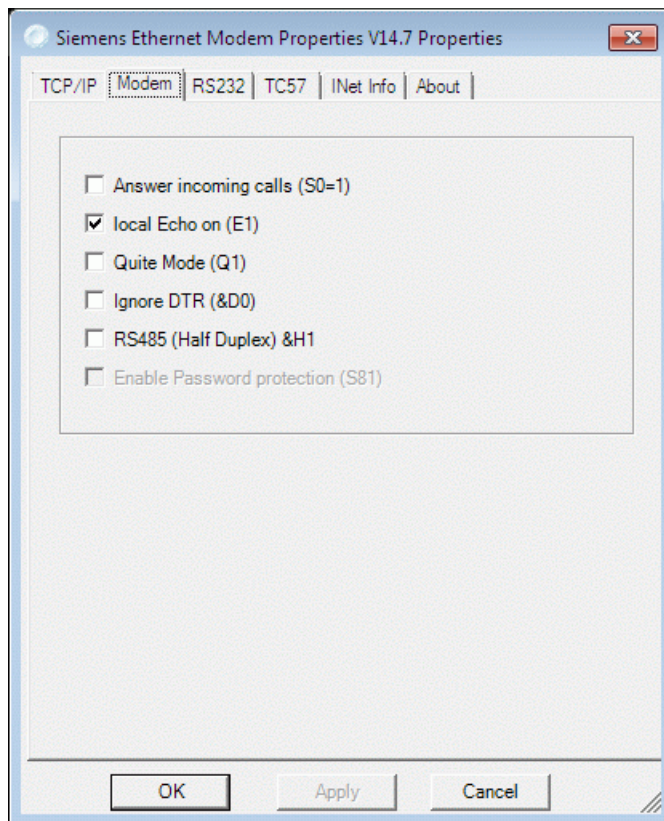

Under "modem", you can set how the modem behaves. Setting a checkmark activates the function in question.

Answer incoming calls activates the automatic call acceptance after the first dialling tone.

Local Echo on (E1) switches on the modem's echo.

Quiet Mode (Q1) switches result codes off.

Ignore DTR (&D0) ignores the DTR status change.
(Not used here !)

RS485 (Half Duplex) &H1 half-duplex control for RS485 with a bus system.

Enable Password protection (de)activates password protection for connection passwords (is blocked in the Serial Modem).

Enable Password protection via the serial interface only, see P.63)

Note: Please follow the application instructions for DIGSI 4 on the included CD/DVD as well as in the Internet under www.siemens.com/siprotec

RS232 Interface Settings (RS232 / RS485 / FO)

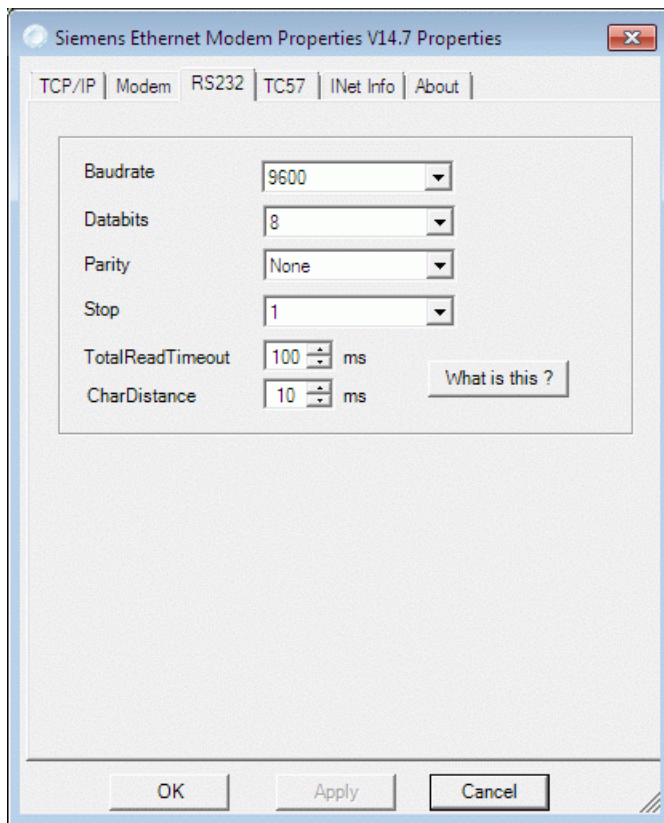

These settings adapt the serial interface of the Serial Modem to that of the terminal device. The terminal device may, for example, be an operating PC or protection unit with a serial interface (SIPROTEC®). These settings apply to all possible connections (RS232 or RS485 or FO).

The settings

Baudrate
Databits
Parity and
Stop bits

are adjusted to the communication behaviour of the serial terminal device.

Under **TotalReadTimeout**, it is usually OK to accept the default value of 100 ms.

The ideal signal throughput time can be ascertained with the "ping" tool (see below) or the "INet Info" dialog box.

CharDistance (i.e. character interval) with default value 5 ms should only be changed in exceptional cases.

TC57 Settings (Ethernet)

If a frame in TC57 format is received via the RS232 interface, it is sent immediately via the Ethernet without a "timeout". This procedure clearly increases the performance of the connection and ensures uninterrupted transmission of frames.

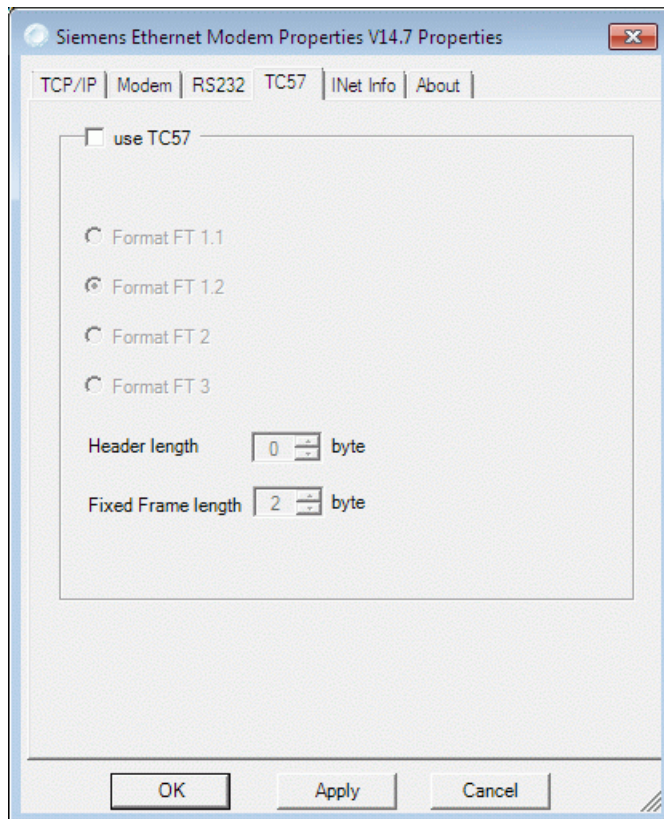

The IEC 60870–5–1 and IEC 60870–5–2 standard defines four standard frame formats for the data link layer. They are:

TC57 Format FT 1.1

TC57 Format FT 1.2

TC57 Format FT 2

TC57 Format FT 3

Frame formats FT 1.2, FT 2 and FT 3 have a frame of fixed length.

The frame with variable length for FT 2 and FT 3 has a header of fixed length. This contains "Start character", "Length", "User data" and "Checksum".

The user must select the required format and enter the values for "Fixed frame length" and "User data length".

The value in the "Fixed frame length" edit box is in the range 2 to 255 bytes.

The value in the "User data length" edit box is in the range 2 to 14 bytes. The value only refers to "User data" from the header.

Note: For the protocols IEC60870-5-103, VDEW or for the protocol used by DIGSI®, the format FT 1.2 (Header length = 0 byte and Fixed Frame length = 2 byte) is required.

INet Info

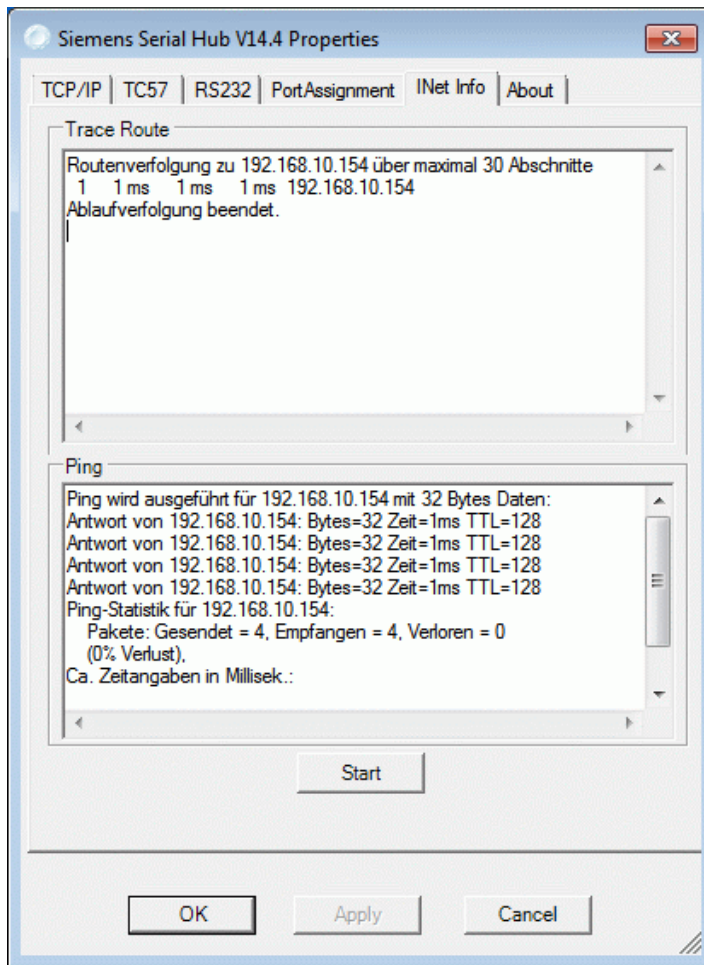

This window provides up-to-date network information.

The "**Start**" button transmits a **ping** to the serial Modem to ascertain the throughput time of the telegrams in the network.

Throughput time + 10ms = ideal "Total Timeout" here <10ms + 10ms = 20ms

About

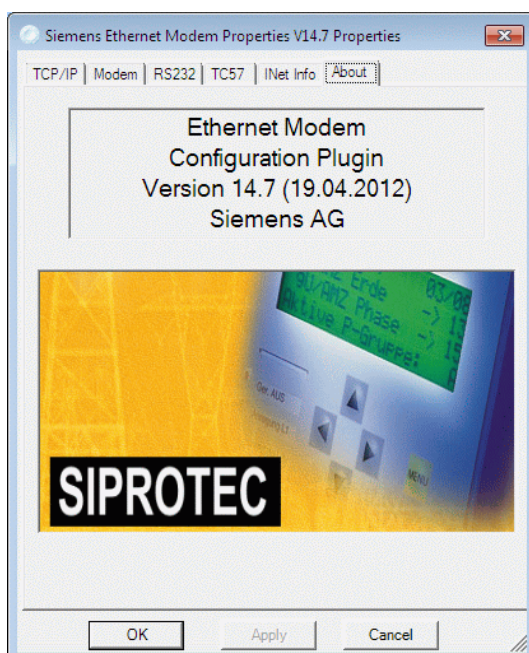

This window provides information about the configuration- and driver version and the date of issue of this configuration tool.

If the PC has Internet access, you can double-click the image for direct access to our **Download Area**.

All up-to-date documents, drivers and updates for our products are available under

www.siemens.com/siprotec.

Optimising Data Transfer

Great emphasis has been placed on compatibility in the design of this device. Due to the Ethernet, there are, however, some minor restrictions. Data is not transmitted in bytes to the network. This is done in data blocks via Ethernet. This might result in minor delays. Block formation function does not directly affect the application but might help to reduce the network load. Some fine tuning might be necessary for time-critical applications. This involves the two timeout parameters ("Total Read Timeout", "Character Distance").

Block Formation for Serial Data before Transmission into the Ethernet

After the first byte has been received, "Total Read Time" starts. After the time expires, all characters received so far are relayed to the Ethernet. The default value is 50 ms.

"Character Distance" is the maximum interval between two received characters. If this is exceeded, all characters received so far are transmitted into the Ethernet. The default value is 5 ms.

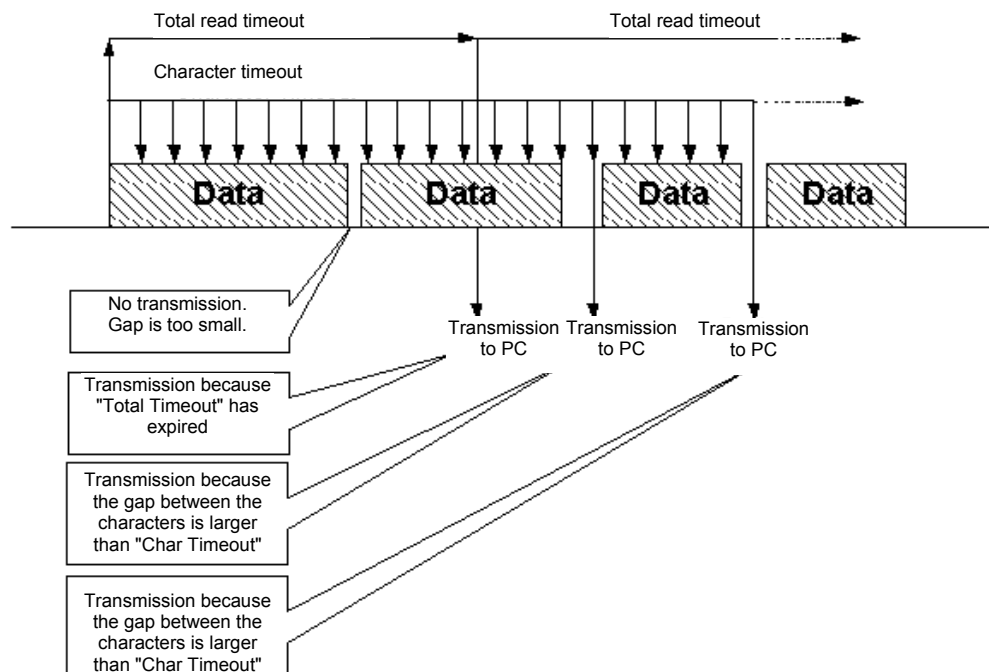

Protocol Code TC57 for Transmission into the Ethernet

This procedure considerably enhances transmission rates when TC57 compatible protocols are transmitted. If the RS232 interface detects a protocol package of this type, it is transmitted as a block via the Ethernet immediately, without waiting for a timeout to elapse.

The Serial Modem can be adapted to various standards.

The IEC 60870–5–1 and IEC 60870–5–2 standards define four standard frame formats for the data link layer:

0 = Format FT 1.1

2 = Format FT 2

1 = Format FT 1.2

3 = Format FT 3

Frame formats FT 1.2, FT 2 and FT 3 have a frame of fixed length.

The frame with variable length for FT 2 and FT 3 has a header of fixed length. This contains "Start character", "Length", "User data" and "Checksum".

The user must select the required format and enter the values for "Fixed frame length" and "Header length".

Protocol code for IEC 60870-5, VDEW and DIGSI®

The IEC 60870–5–102 / 103, VDEW, DIGSI® V3 and DIGSI® 4 protocols are identical to or similar to this specification so that the protocol code of this Serial Modem can be used.

This is done by activating the protocol code, selecting format FT1.2 and setting a fixed frame length of 2 bytes.

Control Commands

Your Serial Modem is the latest in Ethernet modems and is equipped with the AT command set. To enter the AT commands, you require a terminal program, e.g.: "HyperTerminal". This program is part of MS WINDOWS® and can be started under "Start - Programs - Accessories".

AT Command Entry and Execution

After power-on, the Serial Modem is ready for command input. Only in this mode can commands be accepted, interpreted and executed.

Command must always be entered with the currently set baudrate and data format (factory setting 9600 baud 8N1), otherwise the commands are ignored. If the factory setting has been changed, further operation or initialisation must be made with the new parameters.

If you do not know the settings, you can reset the modem to its default (factory) setting of 9600 baud 8N1 by pressing the INIT key (see p14).

All commands directed at the Serial Modem must be prefixed with the ASCII code AT or at (not permitted: At or aT) and be followed by "Enter". If several commands are to be entered, they can each be entered with the AT prefix and "Enter". It is also permissible to place these commands on a single line between an introductory AT and finish the command input with the "Enter" key.

For readability you might want to separate the individual commands with spaces. On reaching the end of the command line buffer, no further character entry is possible. The command line can, however, be edited with the "backspace" key or executed by pressing "Enter".

In password configuration mode, all commands, e.g. the passwords or valid IP addresses are entered individually.

After command entry, the settings are only stored in the volatile RAM. To retain the settings through an auxiliary power interruption, they must be saved to flash EPROM with the "AT&W" command.

On-Line Data Mode

After a successful connection setup to a remote terminal, the modem switches from command mode to on-line data mode.

The on-line data mode means that a connection to a remote data terminal (i.e. another modem) has been established: The modem is on-line (CONNECT). This applies to a successful connection setup (outgoing call / dialling) as well as to answering a call (call accept). In this mode, data exchange (data transmission) between two connected data terminals can take place.

To revert to command mode and back again while the connection is up, use the Escape and ATO commands. The Escape command consists of a sequence of three Escape characters (default setting: +++) and a valid command line. The Escape character is not the same as the  character of the ASCII character set. It can be changed with the S2 register.

After the three Escape characters have been entered, the modem switches to command mode. There is, however, no transmission interrupt before a valid command line is recognised.

Status: Online Mode
 Command: +++ [2-second pause]
 Status: Command Mode
 Command: ATO
 Status: Online Mode

Quick Reference for AT Commands and Registers

This chart, sorted by topic, provides frequently used AT commands and registers that enable you to modify the configuration of your Serial Modem.

Configuration	Commands	Registers
Default modem initialisation	AT&F	
Connection setup (dialling)	ATD	S37, S102
Call accept, dial, hang up	ATA, ATD, ATH,	S0
Switch between command and on-line data mode	+++, ATO	S2
Read out modem information	ATI, ATS, AT%V, AT&V	
Store initialisations	AT&W	
(Controls the effect of DTR) (not applicable here)	AT&D	S37
Controls modem responses	ATE, ATQ, ATV, AT&D	S37
Password configuration mode and password protection	ATP, ATZ	S81, S82, S83
Call accept from valid IP address	ATR	S110 – S119

Description of AT Commands

Hayes Commands

The Hayes command set (AT commands) has over time developed into an industry standard among modem manufacturers. In addition to these, manufacturers use their own modem commands that are specific to the brand. Some of these commands are not compatible with modems of other manufacturers.

ATA Call accept

This command makes the modem go off-hook to connect to the calling remote modem. If no signal is recognised after a specified time, the modem hangs up again.

ATD Dialling function.
 → *ATDipaddress*
 ATDP and ATDT are suppressed and executed as ATD
 P = pulse dial, T= tone dial
 → ATD192.109.223.4 → ATD192,109,223,4
 → ATDP192.109.223.4 → ATDP192,109,223,4
 → ATDT192.109.223.4 → ATDT192,109,223,4

ATE Activates/deactivates command echo:
 → ATE0 echo off
 → ATE1 echo on

ATH Makes modem go on or off hook.
 → ATH0 modem hangs up (goes on-hook), the connection is broken off.
 (Only possible in command mode)
 → ATH1 modem goes off hook (identical function to ATO).

ATN Assigns the modem a name
 A device name can be assigned to the modem (up to 20 characters, is stored in capital letters).
 → *ATN=name* Assigns a device name
 → ATN? Reads out a device name

ATO Returns to data mode.

→ ATO

Note: By entering +++ you can switch to command mode during a modem connection, where AT commands can be executed. This does not break off the connection. The ATO command terminates the command mode.

ATP Activates and deactivates the password configuration mode of the modem.

→ ATP<Enter> Activates password configuration mode

Only after first start-up when the password register is empty (default) or if no master password has yet been assigned. After that a master password can be assigned (see command ATZ).

→ ATP*master password* Activates password configuration mode

→ AT&P Ends password configuration mode.

Note: After successful entry of the master password, passwords can only be set or changed at the local serial interface.

The master password is only relevant to password configuration mode and the user passwords for connection, i.e. data transmission.

Passwords have a maximum length of 8 characters and are always transmitted encrypted.

Password protection can be switched on/off in password configuration mode by setting the register 81.

ATS81=1 activate; default = off (ATS81=0).

If the master password has been forgotten, the device must be sent in.

(For address, see last page of this manual)

ATQ Activates/deactivates modem echo.

→ ATQ0 send echo

→ ATQ1 no echo

ATR Valid IP addresses for call accept.

→ ATR*number=value* (number = 0-9)

→ ATR2=192.168.120.23

→ ATR2? read out register (see also AT&R)

Ten IP addresses, for which calls are accepted, can be defined in the password configuration mode (registers 110-119).

If this list is empty, calls are accepted from any remote modem.

If a call is not accepted by a modem the "ACCESS DENIED" message is output.

ATS Sets and queries the internal modem registers.

→ ATS*register=value* Sets the register

Example: → ATS0=1 modem answers a call after 1 ring.

→ ATS*register?* Queries the register:

Example: → ATS0? (output "+" default setting)

ATV Returns system echo of modem as character string or digits.

→ ATV0 response is a number

→ ATV1 response is a character string ("Ring", "Connect", "Busy")

See also section "Result Codes".

- ATZ** Change passwords.
- ATZ=*master password* Changes the master password (default empty)
 - ATZ1..9=User password Assign user password.
 - ATZ1? Queries the set password for checking
 - ATZ=<Enter> Deletes the master password.
 - ATZ1..9=<Enter> Deletes the user password.

Entries are only possible in password configuration mode (see ATP).

Up to 9 passwords may be saved in the modem.

Passwords consist of up to 8 characters, no distinction is made between upper and lower case letters. Special characters are allowed.

If the master password has been forgotten, the device must be sent in.

(For address, see last page of this manual)

- AT%V** Outputs the firmware version.
- AT%V (is equivalent to AT13)

- AT&F** Loads the default configuration.

→ AT&F

This command loads the factory (default) settings. The IP address and all settings that are only set in password configuration mode are retained.

Note:

The following registers were not reset:	
Register	Definition
S1	Number of rings (read only)
S31	Baud rate
S32	Parity
S33	Data bits
S34	Stop bits
S81	Password protection
S99	Time between two rings
S100	Own IP
S101	Default gateway
S103	Subnet mask
S104	MAC address
S110-119	Valid IP addresses for call accept

This command is also only executed with the currently set baud rate and the appropriate data format, i.e. the modem does not feature automatic baud rate detection.

- AT&P** Ends password configuration mode
Only possible in password configuration mode (see ATP).
- AT&R** Outputs a list of all set IP addresses for call accept.
Only possible in password configuration mode (see ATP and ATR).
- AT&V** Displays the current configuration.
- AT&W** Stores the current configuration in flash.
- AT&Z** Displays a list of all set passwords
(master password and connection passwords)
Only possible in password configuration mode (see ATP and ATZ).

Overview of Registers

The modem has internal registers, enabling you to modify its configuration (see also ATS command).

Register	Definition	Default	Options
S0	Auto answer	0	[0..9] rings
S1	Number of rings	0	Read only
S2	Escape character	+	ASCII
S3	CR character	0x0d	ASCII
S4	LF character	0x0a	ASCII
S5	BS character	0x08	ASCII
S30	Inactivity timer	0	[0..255] s (from device software 14.x on)
S31	Baud rate	3	1=2400 2=4800 3=9600 4=19200 5=38400 6=57600 7=115200
S32	Parity	0	0=None 1=Even 2=Odd 3=Mark 4=Space
S33	Data bits	8	7=7 8=8
S34	Stop bits	1	1=1 2=2
S35	RxD timeout	100	[5..255] ms
S36	Char timeout	10	[5..255] ms 0=Off
S37	Bit options	5	[0..255] decimal value
S38	Use TC57	0	[0..1]
S39	TC57 type	1	[0..3]
S40	Fixed frame length	2	[2..255]
S41	User data length	2	[2..14]
S81	Password protection	0	[0..1]
S82	Password blocking time	3	[0..255] minutes 0=Off
S83	Wrong password entry	0	[0..255] in the RAM only
S99 *	Time between two rings	4	[0..255] s
S100	Own IP	10.10.5.1	xxx.xxx.xxx.xxx
S101	Default gateway	0.0.0.0	xxx.xxx.xxx.xxx
S102	Auto remote	0.0.0.0	xxx.xxx.xxx.xxx
S103	Subnet mask	255.255.255.0	xxx.xxx.xxx.xxx
S104	MAC address	00:09:8E:x:x:x	Read only
S110 *	Valid IP address	0.0.0.0	xxx.xxx.xxx.xxx
S111 *	Valid IP address	0.0.0.0	xxx.xxx.xxx.xxx
S112 *	Valid IP address	0.0.0.0	xxx.xxx.xxx.xxx
S113 *	Valid IP address	0.0.0.0	xxx.xxx.xxx.xxx
S114 *	Valid IP address	0.0.0.0	xxx.xxx.xxx.xxx
S115 *	Valid IP address	0.0.0.0	xxx.xxx.xxx.xxx
S116 *	Valid IP address	0.0.0.0	xxx.xxx.xxx.xxx
S117 *	Valid IP address	0.0.0.0	xxx.xxx.xxx.xxx
S118 *	Valid IP address	0.0.0.0	xxx.xxx.xxx.xxx
S119 *	Valid IP address	0.0.0.0	xxx.xxx.xxx.xxx

* Registers are not output with AT&V

Description of Registers

S0 Automatic call accept

Range 0 ... 9 rings

Default **0**

In the S0 register, you can set the automatic call accept (auto answer). If $S0 > 0$, each incoming call is automatically answered. The value in S0 defines the number of rings the modem waits before it auto answers.

If the entered value is not within the valid range, the modem automatically enters the next possible value (minimum or maximum value) defining the number of rings the modem waits. If, for instance, you enter 10 in Germany, the modem automatically enters 9.

S1 Ring Counter

Range 0 ... 255 rings

Default **0**

The S1 register contains the number of rings of an incoming call. The value in S1 is reset to zero, if no rings have arrived for a time span specified in the S99 register (default 5 seconds). During this time new incoming calls cannot be distinguished and the modem cannot dial.

Storage in non-volatile memory is not possible.

S2 Escape Code Character

Range 0 ... 255 decimal

Default **43 (+)**

In the S2 register, you can define the Escape command '+++', allowing you to switch from on-line data mode to command mode.

Values 0 or >128 block switchover to command mode.

S3 Carriage Return Character

Range 0 ... 127 decimal

Default **13 (Carriage Return)**

Register S3 defines the return character.

S4 Linefeed Character

Range 0 ... 127 decimal

Default **10** (Linefeed)

Register S4 defines the linefeed character.

S5 Backspace Character

Range 0 ... 32, 127 decimal

Default **8** (Backspace)

Register S5 defines the backspace character.

S30 Inactivity Timer

Range 0 ... 255 (from device software 14.x on)

Default **0** (timer off)

In register S30, you can set the time the modems waits before it kills the connection automatically, if there has been no reception or transmission of data in the meantime. 0 deactivates the inactivity timer (Entry in seconds).

S31 Baudrate

Range 1 ... 7

Default **3** (= 9600 baud)

In the S31 register, you can set the baud rate. The baud rate defines the number of state changes of the transmitted signal per second.

1=2400 2=4800 3=9600 4=19200 5=38400 6=57600 7=115200

S32 Parity

Range 0 ... 4

Default **0** (no parity)

In the S32 register, you can set the parity bit

for error detection during asynchronous data transmission. Part of the data transmission format. Occasionally no parity, constantly one (mark) or zero (space). Even parity means that the bit is set, if the data bit number is even and vice versa for odd parity.

0=None 1=Even 2=Odd 3=Mark 4=Space

S33 Data Bits

Range 7 ... 8

Default 8

In the S33 register, you can set the number of data bits.

7=7 Bits 8=8 Bits

Format 7N1 (7 data bit and no parity) is invalid

S34 Stop Bits

Range 1 ... 2

Default 1

In register S34, you can set the number of stop bits. One or two bits in asynchronous transmission, indicating the end of a data word (packet).

1=1 stop bit 2=2 stop bits

S35 RxD Timeout (Total Read Timeout)

Range 5 ... 255 ms

Default 100 ms

In register S35, you can set the total read timeout.

After the first byte has been received, "Total Read Time" starts. After it has expired, all characters received so far are sent to the PC. This value must not be lower than the delay of the UDP packet in the Ethernet. You can use the "ping" tool in DOS to determine the throughput time.

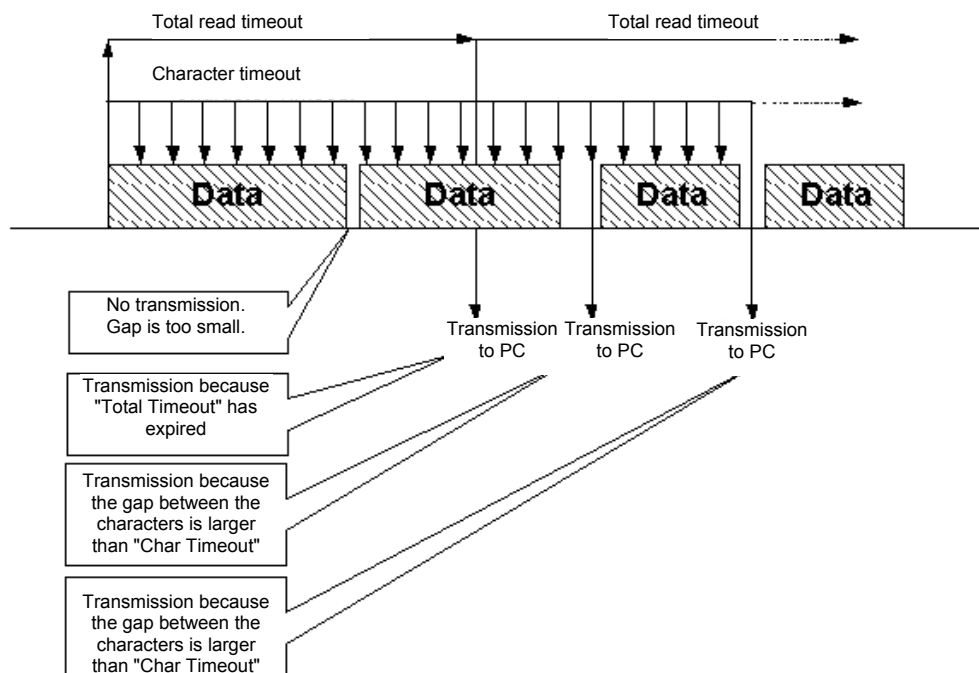
**S36 Char Timeout (Character Distance)**

Range 5..255 ms

Default **10 ms**

In register S36, you can set the character distance, i.e. the character interval.

If the time between two received characters (bytes) is greater than the defined character timeout, all bytes received so far are sent to the Ethernet

S37 Bit Options

Range 5 ... 255

Default **5** (binary: 0000 0101)

In register S37, you can set the bit options, see table below.

Bit	Effect	Default	Definition
2^7	n/c	0	
2^6	n/c	0	
2^5	n/c	0	
2^4	Q0 / Q1	0	Echo (see ATQ)
2^3	n/c	0	
2^2	&D0 / &D1	1	DTR control line (see AT&D) (not applicable here)
2^1	V0 / V1	0	System echo (see ATV)
2^0	E0 / E1	1	Command "echo" (see ATE)
			00000101 binary = 5 decimal

S38 Activate/Deactivate TC57 Code

Range 0 ... 1

Default **0**

The advantage of the TC 57 settings is that on receiving a frame with this format (from the RS232 line) the frame is immediately sent on to the Ethernet without having to wait for a timeout. This greatly improves communication speed and performance.

0 = registers 38-41 are inactive (default). 1 = registers 38-41 are active.

S39 Select TC57 Type

Range 0 ... 3

Default 1

The IEC 60870–5–1 and IEC 60870–5–2 standards define four standard frame formats for the data link layer:

0 = Format FT 1.1 2 = Format FT 2

1 = Format FT 1.2 3 = Format FT 3

Frame formats FT 1.2, FT 2 and FT 3 have a frame of fixed length.

The frame with variable length for FT 2 and FT 3 has a header of fixed length. This contains "Start character", "Length", "User data" and "Checksum".

The user must select the required format and enter the values for "Fixed frame length" and "User data length".

S40 TC57 Fixed Frame Length

Range 2 ... 255

Default 2

The value in the "Fixed frame length" edit box is in the range 2 to 255 bytes.

S41 TC57 User data length

Range 2 ... 255

Default 2

The value in the "User data length" edit box is in the range 2 to 14 bytes. The value only refers to "User data" from the header.

S81 Password Protection

Range 0 ... 1

Default 0

Register 81 activates and deactivates password protection.

Changes are only possible in password configuration mode (see ATP).

The default value is 0 (password protection inactive).

If password protection has been activated, the modem will exhibit the following behaviour:

After dial-up the modem outputs the message "PASSWORD:". The user has three tries at entering the password correctly. Then the modem is blocked for a definable time (see S82).

Incorrect password entries are counted (in the RAM only) ATS83.

DCD is only activated in the remote modem after successful password entry. After three incorrect password entries, the remote modem goes on-hook without any call-back. "NO CARRIER" appears.

S82 Password Blocking Time

Range 0 ... 255 minutes

Default 3 (minutes)

The blocking time is set in register 82. After three incorrect password entries the modem allows no further password request until the blocking time has elapsed. (0 = function deactivated).

Changes are only possible in password configuration mode (see ATP).

S83 Incorrect password entries

Range 1 Byte

Default 0

All incorrect password entries are counted in register 83. The value is only stored in the RAM, i.e. the counter in register 83 is back at 0 (zero) after an auxiliary power failure.

S99 Time Distance Between Rings

Range 10 ... 255

Default 4 (seconds)

In register S99, you can set the maximum permissible time interval between two received rings. The default value of 7.5 seconds is OK in most cases.

S100 IP Address

Range xxx.xxx.xxx.xxx

Default 10.10.5.1

In register S100, you can set your own IP address. The factory-set value of 10.10.5.1 must be adjusted to your network

Bear in mind, when modifying this value, that it cannot be chosen freely, but depends on the network address of the TCP/IP network. The address is entered in the familiar syntax (e.g. 192.168.31.5).

S101 Default Gateway

Range xxx.xxx.xxx.xxx

Default 0.0.0.0

In register S101, you can set the default gateway. Here you enter the gateway IP address, if connections to other subnetworks are to be established.

S102 Auto Remote

Range xxx.xxx.xxx.xxx

Default **0.0.0.0**

In register S102, you can set the auto remote partner. Enter the IP address of the "communication partner" to which a connection is to be established automatically (leased line).

After a connection break-off there is an automatic attempt at restoring the connection. The connection set-up and take-down can be controlled via DTR (see AT&D). Here the DTR signal is not applicable in this device (refer to register S30 Timeout).

S103 Subnet Mask

Range xxx.xxx.xxx.xxx

Default **255.255.255.0**

In register S103, you can set the subnet mask. The subnet mask only needs to be entered if the IpEther232.Modem is to be connected to another subnetwork.

In this case, enter the subnet mask for the subnetwork where the ipEther is located (e.g. 255.255.255.0).

Note: The IP address also defines the network class. This results in a default subnet mask (e.g. 255.255.0.0 for a Class B network). It can only be extended "towards the right".

S104 MAC Address

Range 00:09:8E:xx:xx:xx

This register contains the Mac address of the network interface, which cannot be changed.

S110 - S119 Valid IP Addresses

Range xxx.xxx.xxx.xxx

Default **0.0.0.0**

In registers 110 to 119, IP addresses can be set for which a call is accepted (read out: e.g.: AT\$112?). If no register contains an IP address, all calls are accepted.

If a call is not accepted by a modem, the "Access Denied" message is shown.

Result Codes

System return code as a character string or digits (see AT command ATV).
If system result codes are not suppressed with ATQ1.

Char string	Digit	Definition
OK	0	Command line processed
CONNECT	1	Successful connection setup
RING	2	Incoming call
NO CARRIER	3	No connection established or inactivity timer expired or connection broken off
ERROR	4	Error in command input
NO DIALTONE	6	No Ethernet connection
BUSY	7	Dialled line engaged
ACCESS DENIED	8	Call rejected due to failed password authentication
Password	11	Password OK
Wrong Password	12	Incorrect password

Optimising Data Transfer

Great emphasis has been placed on compatibility in the design of this device. Due to the Ethernet, there are, however, some minor restrictions. Data is not transmitted in bytes to the network, but Ethernet blocks are formed. This might result in minor delays. Block formation function does not directly affect the application but might help to reduce the network load. Some fine tuning might be necessary for time-critical applications as well. This involves the two timeout parameters ("Total Read Timeout", "Character Distance").

Block Formation for Serial Data before Transmission into the Ethernet

After the first byte has been received, "Total Read Time" starts. After the time expires, all characters received so far are relayed to the Ethernet. The default value is 50 ms.

"Character Distance" is the maximum interval between two received characters. If this is exceeded, all characters received so far are transmitted into the Ethernet. The default value is 5 ms.

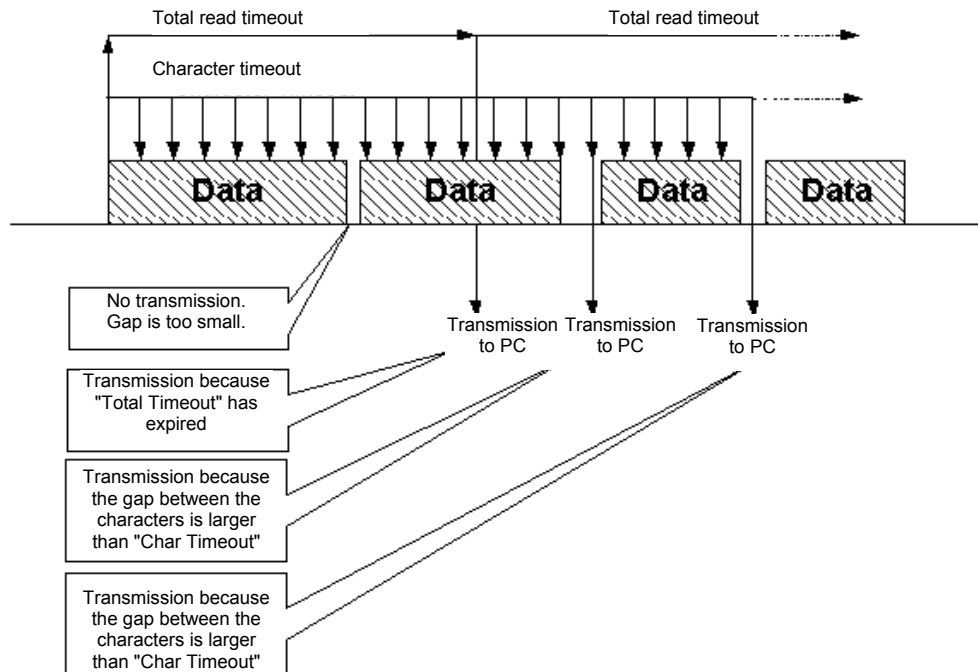

Protocol Code TC57 for Transmission into the Ethernet

This procedure considerably enhances transmission rates when TC57 compatible protocols are transmitted. If the RS232 interface detects a protocol packet of this type, it is transmitted as a block via the Ethernet immediately without waiting for a timeout to elapse.

The Serial Modem can be adapted to various standards.

The IEC 60870–5–1 and IEC 60870–5–2 standards define four standard frame formats for the data link layer:

0 = Format FT 1.1	2 = Format FT 2
1 = Format FT 1.2	3 = Format FT 3

Frame formats FT 1.2, FT 2 and FT 3 have a frame of fixed length.

The frame with variable length for FT 2 and FT 3 has a header of fixed length. This contains "Start character", "Length", "User data" and "Checksum".

The user must select the required format and enter the values for "Fixed frame length" and "User data length" (see registers S38 - 41).

Protocol code for IEC 60870-5, VDEW and DIGSI®

The IEC 60870–5–102 / 103, VDEW, DIGSI® V3 and DIGSI® 4 protocols are identical to or so similar to this specification that the protocol code of this Serial Modem can be used.

This is done by activating the protocol code, selecting format FT1.2 and setting a fixed frame length of 2 bytes (see registers S38 - 40).

Note: If a partner modem is dialled in an application (e.g. DIGSI®) from an "Ethernet office modem" with the supplied modem driver, the office modem is first reset to the factory settings with the "AT&F" command.

That also affects the TC57 settings, i.e. the settings must be passed on again in the dialling string.

For a typical application with VDEW or DIGSI® protocol, that would be S38=1; registers S39 and S40 are already set accordingly.

Note: All up-to-date documents, drivers and updates for our products are available under www.siemens.com/siprotec

Setting Up Password Protection

The Serial Modem features extensive password protection. This protects the called modem (substation modem) from unauthorised external access. The password is always transmitted encrypted via the Ethernet.

Password protection can only be configured after entering the master password in the password configuration mode with the terminal program via the serial interface, i.e. locally.

Note: The connection via the serial RS232 interface can only be established with the baudrate and data format currently set in the modem.

Activating Password Configuration Mode

You enter the configuration mode the first time by entering `ATP<Enter>`, i.e. no master password has been assigned yet. If the master password has been changed, the new master password must be entered.

- `ATP<Enter>` Entry on initial configuration.
- `ATPmaster password` Entry of the changed master password.

Changing / Deleting the Master Password

By entering `ATZ="new master password"`, you can change the master password.

- `ATZ=master` Password is "master" or "Master" or "MASTER"
- `ATZ=<Enter>` Deletes the password

If the master password has been forgotten, the device must be sent in.

(For address, see last page of this manual)

Assigning / Changing / Deleting User Passwords

A further 9 passwords can be set up (`ATZ1...ATZ9`).

- `ATZ1=secret` Password is "secret" or "Secret" or "SECRET"
- `ATZ1=<Enter>` Deletes the password

Each password can be up to 8 characters long. (Excess characters are ignored.) Case is ignored when passwords are entered and special characters are permitted.

Reading Passwords

`ATZ?` or `ATZ1?...ATZ9?` enable you to read out individual passwords and `AT&Z` all passwords.

- `ATZ1?` Password 1 is output
- `AT&Z` All passwords are listed

Activating Password Protection

Register 81 lets you activate or deactivate password protection for establishing connections with the remote Serial Modem.

- `ATS81=1` Activates password protection
- `ATS81=0` Deactivates password protection

Password Blocking Time

A password blocking time can be defined in register S82.

After three incorrect password entries the modem allows no further password request until the blocking time has elapsed.

→ AT S82=2 blocking time of two minutes

Saving Changes:

All changes are only applied when they are saved.

Saving is performed by entering AT&W.

→ AT&W

Note: If the settings are not saved, all changes are lost as soon as the Serial Modem is disconnected from the power supply.

Ending Password Configuration Mode:

Entering AT&P ends configuration mode.

→ AT&P Ends password configuration mode

Selecting a Password-Protected Serial Modem

Selecting the Remote (Substation) Modem

After you have selected a password-protected Serial Modem, the message "PASSWORD:" appears to prompt you to enter the password.

Entering a Password

To establish a link, you must enter one of 9 user passwords and confirm with "Enter". Transmission is always encrypted.

If the correct password has been entered, the connection with the device on the remote modem is established.

Note: The master password is only for activating password configuration mode; it does not permit connection setup.

Entering an Incorrect Password

If you enter the wrong password, the message "WRONG PASSWORD" is displayed. You have two more goes at entering the password.

If a call from an IP protected modem is not accepted, the message "ACCESS DENIED" is displayed and the password blocking time starts (register S82).

Note: A repeated call will not be accepted until the password blocking time has elapsed and the correct password has been entered.

Valid IP Addresses for Call Accept

To enhance the security of the called Serial Modem, the user can restrict call acceptance only to a number of permanently stored IP addresses.

Activating Password Configuration Mode

The settings can only be made in password configuration mode. You can enter this mode for the first time by entering `ATP<Enter>`. If the master password has been changed, the new master password must be entered.

- `ATP<Enter>` Entry on initial configuration.
- `ATPmaster password` Entry of the changed master password.

Entering / Changing / Deleting IP Addresses

In password configuration mode, you can store up to ten IP addresses in a list (`ATR0...ATR9`). Any assignment is possible.

If only an IP address is assigned, calls from this IP address only are accepted.

If this list is empty (default), incoming calls from all Serial Modems are accepted.

- `ATR0=192.168.10.12` Calls are accepted by IP address 192.168.10.12 (example).
- `ATR0=<Enter>` IP address 1 is deleted

Note: The connection via the serial RS232 interface can only be established with the baudrate and data format currently set in the modem.

Reading IP Addresses

`ATR?` or `ATR0?...ATR9?` enable you to read individual IP addresses and `AT&R` all IP addresses.

- `ATR0?` IP address 1 is output.
- `AT&R` All IP addresses are listed.

Saving Changes:

All changes are only applied when they are saved.

Saving is performed by entering `AT&W`.

- `AT&W`

Note: If the settings are not saved, all changes are lost as soon as the Serial Modem is disconnected from the power supply.

Ending Password Configuration Mode

After saving the settings, you must end password configuration mode again.

Entering `AT&P` ends configuration mode.

- `AT&P` Ends password configuration mode

Pin Assignment

The cables for RS232 and RS485 are connected to the same port and selected using the DIP switches.

RS232 Interface

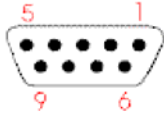
SERIAL PORT 9-pin SubD connector		Pin	Richtung	Definition
		1		Screen
		2	INPUT	RXD Receive Data
		3	OUTPUT	TXD Transmit Data
		4		not connected
		5		GND Ground (ext)
		6		not connected
		7		not connected
		8		Do not assign !
		9		not connected

RS485 Interface

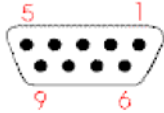
SERIAL PORT 9-pin SubD connector		Pin	Direction	Definition
		1		Screen
		2		Do not assign !
		3	INPUT/ OUTPUT	RS485 Data-A
		4		not connected
		5		GND ground (ext)
		6		not connected
		7		not connected
		8	INPUT/ OUTPUT	RS485 Data-B
		9		not connected

Ethernet Interface

Ethernet connector RJ 45

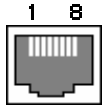

Pin	Name	Definition
1	TX+	Transmit Data+
2	TX-	Transmit Data-
3	RX+	Receive Data+
4	n/c	Not connected
5	n/c	Not connected
6	RX-	Receive Data-
7	n/c	Not connected
8	n/c	Not connected

Ethernet RJ45 connector

Auxiliary Voltage and Earth Connection

3-way terminal block

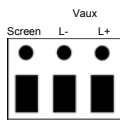

Pin	Name	Definition
1	L+	V_{aux+}
2	L-	V_{aux-}
3	Earth	Protective Earth

The device features internal reverse polarity protection for V_{aux} .

DR Contact

2-way terminal block

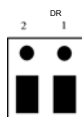

Pin	Name	Definition
1	GOK	Isol. DR
2	GOK-NC	Isol. DR-NC

Connecting Cable

RS232 connection options:

- | | |
|---|--|
| 1) PC/laptop to the Serial Modem (office) | → plug in serial DIGSI cable directly |
| 2) PC/laptop to the protection unit | → plug in serial DIGSI cable directly |
| 3) Station modem to SIPROTEC 4 or
7XV5300, 7XV5450, 7XV5550, 7XV5652 | → plug in serial DIGSI cable via gender
changer (male-male) to Serial Modem |

Serial DIGSI Cable

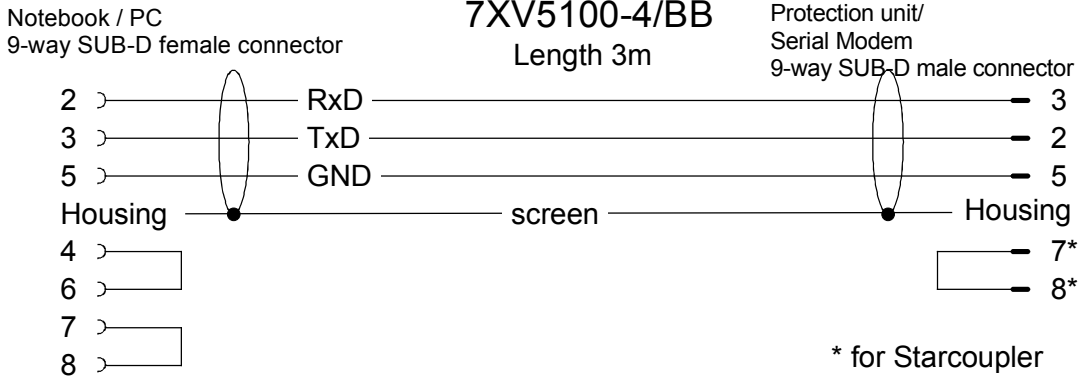

For further cables and adapters, see: www.siemens.com/siprotec

Serial RS485 Connecting Cable

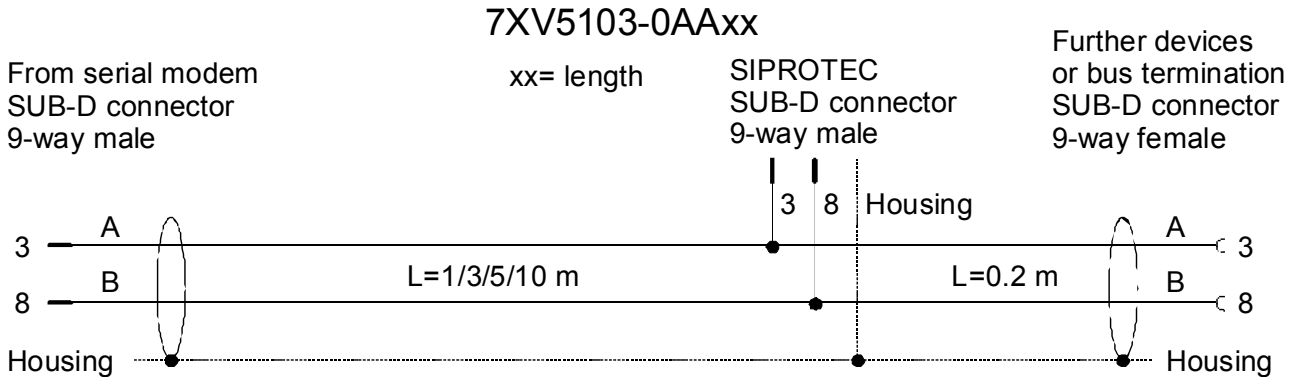

For further RS485 cables and adapters, see: www.siemens.com/siprotec

Technical Data

<p>Auxiliary voltage</p> <p>Power input</p> <p>Line-side fuse</p> <p>Alarm relay (DR) Connection Switching current (continuous) Switching voltage Switching capacity</p> <p>3-way terminal</p> <p>Minimum cross-section of the wires for auxiliary voltage and earth (ground) Nominal conductor cross-section</p> <p>Tightening torque Stripping length:</p>	<p>24 V – 250 V DC +/-20 % 60 V – 230 V AC +/-20 % , 45-65 Hz,</p> <p>2.5 W DC 14 VA AC</p> <p>T 2A/250 V AC and 250 V DC acc. to IEC 60127</p> <p>Relays, 1 NC isolated 2-way screw terminal, 1A 250V AC and DC 20 W / 20 VA</p> <p>1.5 mm²</p> <p>2.5 mm² , rigid conductor or with wire end ferrule</p> <p>0.5 Nm up to 8 mm</p>
<p>FO connection</p> <p>Connection method Wavelength Fibre Type Baud rate Protocol Laser class</p> <p>Transmit power in dBm , peak (type), NA = 0.275 Max. optical power for high level Min. optical power for low level Optical power budget NA = 0.275 Range</p>	<p>ST connector receiver and transmitter 820 nm Multimode fibre, 62.5/125 µm 2400 up to max. 115200 baud full-duplex 1 acc. to EN60825-1/-2 using glass fibre 62.5/125 µm -12.0 (fibre type 62.5/125 µm)</p> <p>Max. -40 dBm peak Min.: -24 dBm peak Min. 8 dB (62.5/125 µm)</p> <p>Max. 2 Km (attenuation 3 dB / Km 62.5 µm) Max. 2 m with plastic fibre</p>
<p>Ethernet interface Connection TCP/IP</p>	<p>10BaseT (10/100 Mbits) RJ45, screened, 8-way UDP Port 3497 (User Datagram Protocol) ICMP (Internet Control Message Protocol) ARP (Address Resolution Protocol)</p>
<p>RS232 and RS485</p>	

<p>Connection type</p> <p>Pin assignment</p> <p>Cable length RS232</p> <p>Baud rate</p>	<p>9-way SubD connector, 4/40 UNC screw connection</p> <p>See Pin Assignment</p> <p>Max. 10 m / 3280 feet</p> <p>2400 to 115200 baud, Rxd, Txd Parity : None, Even, Odd, Mark, Space</p> <p>Data : 7 or 8 bits Stop : 1 or 2 bits RS232 : full-duplex , RS485 : half-duplex</p>
DIP switches	<p>RS232/485 switchover</p> <p>Idle state FO ON/OFF</p> <p>RS485 termination</p>
LED displays	<p>DR (GN): Alarm (Vaux power o.k. and reset o.k.)</p> <p>COM-TxD (GN) : Transmit - RS232 or RS485 or FO</p> <p>COM-TxD (YE) : Receive - RS232 or RS485 or FO</p> <p>System (GN) : Connection to the PC via RS232 detected</p> <p>LAN-TxD (GN) : Transmit Ethernet</p> <p>LAN-TxD (YE) : Receive - Ethernet</p> <p>LAN (GN) : Connection to the Ethernet network</p> <p>Error (RD) : Modem error on RS232/Reset</p>
Firmware Driver	<p>Updatable</p> <p>Setup & configuration tool for WINDOWS[®] XP an WINDOWS[®] 7 32/64 Bit</p> <p>Note :</p>
Mechanical design Housing Dimensions Weight: Degree of protection acc. to EN60529 Protection class	<p>Plastic</p> <p>See Dimension Drawings</p> <p>Approx. 180 g</p> <p>IP20 (housing and terminals)</p> <p>I Protective Earth</p>
Safety Acc. to DIN EN61010 Part 1 Overvoltage category Pollution degree Fire resistance class (acc. to UL94)	<p>III</p> <p>2</p> <p>V0</p>

Standards:	IEC 60255 (product standard) IEEE Std C37.90.0/.1/ VDE 0435 For more standards, see each function
Insulation tests	
Standards: Voltage test (100% test) all circuits except auxiliary voltage and communication interfaces Voltage test (100% test) on auxiliary voltage Voltage test (100% test) only locked communication interfaces Surge withstand capability test (type test) all circuits except communication interfaces, class III	IEC 60255-5 and IEC 60870-2-1 2.5 kV (rms), 50 Hz 3.5 KV DC 500 V (rms), 50 Hz 5 kV (peak value); 1.2 / 50 μ s; 0.5 J; 3pos./neg. surges at 5s intervals

	Warning The 7XV5655-0BA00 is specifically intended for installation in a switchgear cubicle or distribution housing. After installation protective covering must be placed around the entire area of the terminals. Only then is the device sufficiently protected against impermissible contact with live parts.
---	---

EMC tests for immunity (type tests)	
Standards:	IEC 60255-6 and -22 (product standards) EN61000-6-2 (generic standard) VDE 0435 part 301DIN VDE 0435-110
High Frequency Test IEC 60255-22-1, Class III and VDE 0435 Part 303, Class III	2.5 KV (peak); 1 MHz; $\tau = 15$ ms; 400 surges per s; test duration 2s; $R_i = 200 \Omega$
Electrostatic Discharge IEC 60255-22-2, Class III	8 KV contact discharge; 15 KV air discharge pos./neg. polarity, 150 pF; $R_i = 330 \Omega$
Irradiation with RF field , frequency sweep IEC60255-22-3, Class III IEC61000-4-3, Class III	10 V/m, 80 MHz to 1000 MHz: 80% AM, 1 kHz
Irradiation with RF field , single frequencies IEC60255-22-3, IEC61000-4-3 - amplitude-modulated - pulse-modulated	Class III: 10 V/m 80, 160, 450, 900 MHz; 80 % AM 1kHz; duty cycle > 10 s 900 MHz; 50% PM, repetition frequency 200 Hz
Fast transients / bursts IEC 60255-22-4 and IEC61000-4-4 Class IV	4 kV; 5/50 ns; 5 kHz; burst length = 15 ms; Repeat rate 300 ms; pos./neg. polarity; test duration 1 min.; $R_i = 50 \Omega$
High energy surge voltages (SURGE) EN61000-4-5 insulation class 3 - Auxiliary voltages - Relay output	Pulse: 1.2/50 μ s common mode; 2 KV; 12 Ω ; 9 μ F differential mode : 1 kV; 2 Ω ; 18 μ F common mode; 2 KV; 42 Ω ; 0.5 μ F differential mode : 1 KV; 42 Ω ; 0.5 μ F

Conducted RF, amplitude-modulated IEC61000-4-6, Class III	10 V; 150 KHz – 80 MHz; 80 % AM, 1 KHz
Magnetic field with power frequency EN61000-4-8 IEC60255-6	0.5 mT; 50 Hz Class IV: 30 A/m continuous; 300 A/m for 3s; 50Hz
Oscillatory Surge Withstand Capability IEEE Std C37.90.1	2.5 kV (peak); 1 MHz; $\tau = 15 \mu\text{s}$; 400 surges per s; test duration 2s; $R_i = 200 \Omega$
Fast transient surge withstand capability IEEE Std C37.90.1	4 kV; 5/50 ns; 5 kHz; burst length = 15 ms; Repeat rate 300 ms; pos./neg. polarity; test duration 1 min.; $R_i = 50 \Omega$
Damped oscillations IEC 60694, IEC 61000-4-12	2.5 kV (peak value), polarity alternating 100 kHz, 1 MHz, $R_i = 200 \Omega$

EMC tests for emission (type tests)	
Standard:	EN 61000-6-4/3 (generic standard)
Radio interference voltage on lines Auxiliary voltage only IEC CISPR 22	150 kHz to 30 MHz Limit class B
Interference field strength IEC CISPR 11	30 to 1000 MHz Limit value class A

Mechanical tests, vibration and shock stress - stationary use	
Vibration IEC 60255-21-1, Class 2 IEC 60068-2-6	Sinusoidal, 10 to 58 Hz : 0.075 mm ampl. 58 to 150 Hz : 1.0 g accel. 20 cycles in 3 orthogonal axes
Shock IEC 60255-21-2, Class 1	Semi-sinusoidal, 5 g accel., 11 ms duration 3 shocks each in both directions of the 3 axes
Seismic vibration IEC 60255-21-3, Class 1 IEC 60068-3-3	Sinusoidal, 1 to 8 Hz : 4 mm ampl. horizontal 1 to 8 Hz : 2 mm ampl. vertical 8 to 35 Hz : 1 g accel., horizontal 8 to 35 Hz : 0.5 g accel., vertical 1 cycle in 3 orthogonal axes

Mechanical tests, vibration and shock stress - during transport	
Vibration IEC 60255-21-1, Class 2 IEC 60068-2-6	Sinusoidal, 5 to 8 Hz : 7.5 mm ampl. 8 to 150 Hz : 2 g accel., 20 cycles in 3 orthogonal axes
Shock IEC 60255-21-2, Class 1 IEC 60068-2-27	Semi-sinusoidal, 15 g accel., 11 ms duration 3 shocks each in both directions of the 3 axes
Shock IEC 60255-21-2, Class 1 IEC 60068-2-27	Semi-sinusoidal, 10 g accel., 16 ms duration 1000 shocks each in both directions of the 3 axes

Climatic tests	
Recommended operating temperature	0 °C to 55 °C
Limit temp. during operation	-5 °C to +70 °C
Limit temp. during storage	-25 °C to +55 °C (factory packing)
Limit temp. during transport	-25 °C to +70 °C (factory packing)
Humidity Maximum relative humidity	80 % at temperatures up to 31 °C, decreasing linearly down to 50 % at 40 °C
Installation altitude Maximum height above sea level	2,000 m

All devices must be installed so that they are not exposed to direct sunlight, nor subject to great fluctuations in temperature that may cause condensation.

Dimensions

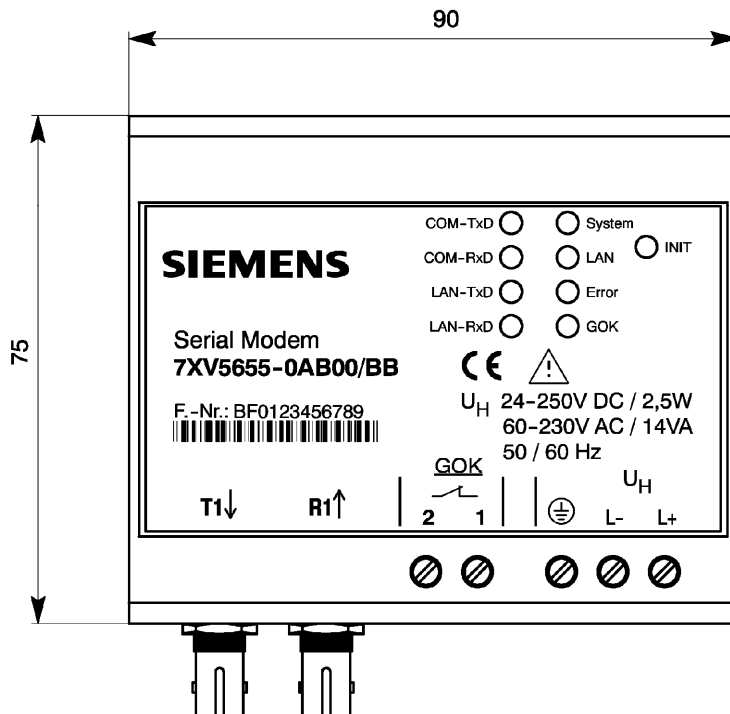
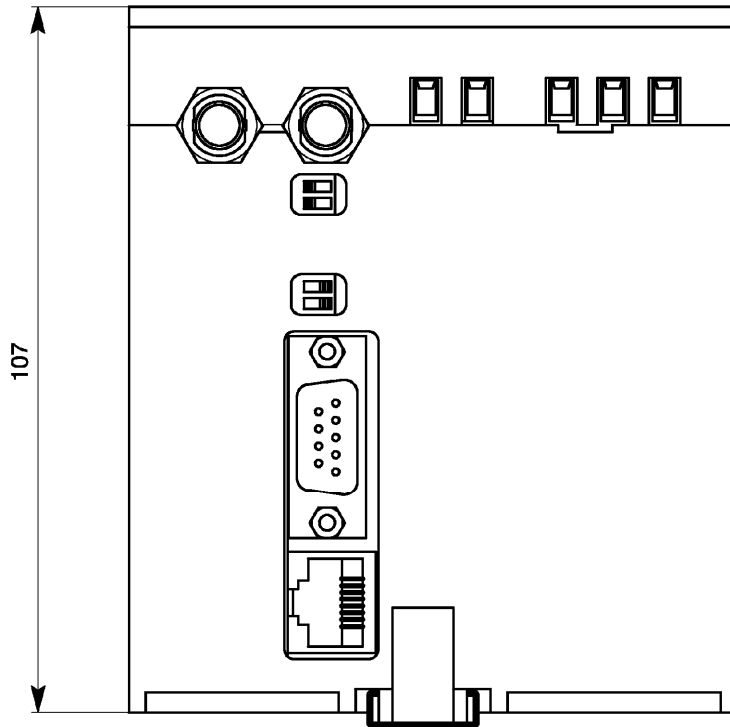

Ordering Information

Name	Order No.												
Serial Modem	7	X	V	5	6	5	5	-	0	B	B	0	0
10BaseT connection 10/100 Mbits, RJ45 connector Serial RS232/485 interface 9-way Sub D connector Gender changer (male-male) FO interface, ST connection DIN rail mounted device for 35mm rail Aux. voltage 24-250 VDC / 60-230 VAC													

If you have any comments or questions regarding this product please contact :

Siemens AG

Infrastructure & Cities Sector
Smart Grid Division
Energy Automation

Tel : +49 180 524 8437 (248437 correspondes to "cities" on telephone keypad)

Fax: +49 180 5242471

E-Mail: support.ic@siemens.com

Internet: www.siemens.com/siprotec

Weitergabe sowie Vervielfältigung dieser Unterlage, Verwertung und Mitteilung ihres Inhalts nicht gestattet, soweit nicht ausdrücklich zugestanden. Zuwiderhandlungen verpflichten zu Schadenersatz. Alle Rechte für den Fall der Patenterteilung oder GM-Eintragung vorbehalten.

The reproduction, transmission or use of this document or its contents is not permitted without express written authority. Offenders will be liable for damages. All rights, including rights created by patent grant or registration of a utility model or design, are reserved. Release 3.00.00

Änderungen vorbehalten
Subject to change without prior notice