

GOOSE Inspector

7XS5900-0AA00

Online Monitoring Tool for IEC 61850

General Description

With the Online Monitoring Tool GOOSE Inspector you can capture IEC 61850 related packets from the station bus. The IEC 61850 telegrams can be decoded, checked, displayed, filtered, stored in a ring buffer and if necessary be printed.

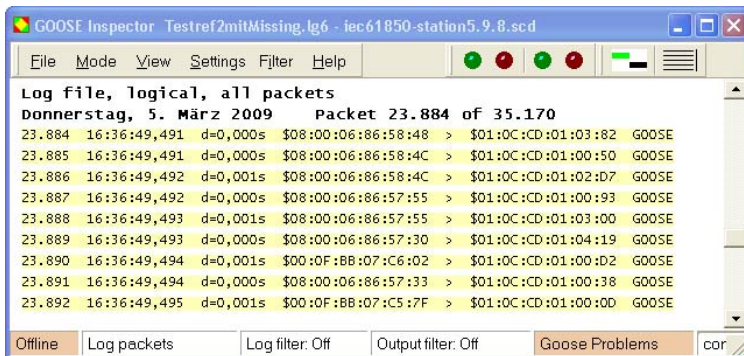

Picture 1: main window with menu and packet list

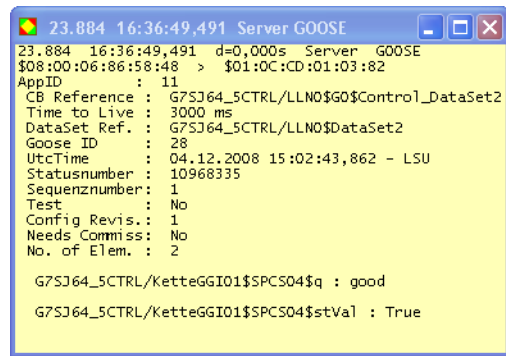

Picture 2: Detail view window

Through the Import of a **Station Configuration Description** file (SCD) the users of Siprotec devices and DIGSI will have a comfortable view with the **Siemens Application Monitor** (SAM). To reduce the complexity in using the GOOSE Inspector, the view of the SAM is similar to the well known graphical user interface of the DIGSI station configurator. The tool observes the GOOSE transmission at the Ethernet network and displays the actual status of each application and GOOSE message with colored icons (according to traffic lights).

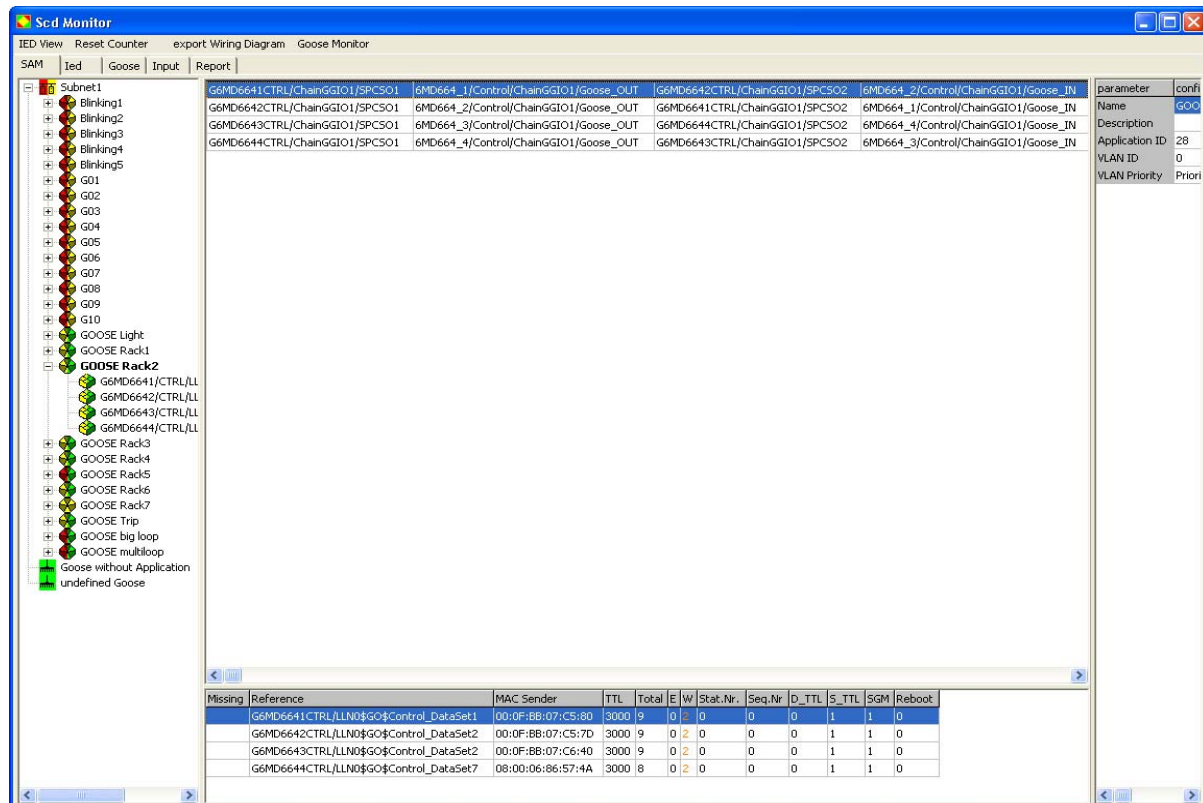

Picture 3: SAM (Siemens Application Monitor) with integrated GOOSE-Monitor

With SAM it is also possible to export a signal list, which shows all the sources and dedicated destinations of all applications, which supports a step-by-step test and documentation of all IEC 61850 signals.

Concept

With GOOSE Inspector also users without detailed knowledge of IEC 61850 standard can monitor and evaluate the existing GOOSE communication. After importing the SCD-file the GOOSE Inspector checks without complex configuration the GOOSE messages which are available at the station bus. The check contains the verification of the configured and captured GOOSE parameters and additionally the periodical and complete appearance of all GOOSE messages. In the following some examples for warnings and errors, which will be calculated and displayed in real-time:

Criteria for a GOOSE-warning:

- A GOOSE message will be received with a short delay
- Loss of a single GOOSE-message
- Small variance between captured and configured GOOSE-message

Criteria for a GOOSE-error:

- Missing GOOSE-message
- Loss of multiple GOOSE-messages
- A Status (eg. Switching status) was skipped
- Severe variance between captured and configured GOOSE-message
- Unconfigured, but captured GOOSE-messages

The SAM displays the actual status of applications and GOOSE-messages via colored icons like traffic lights. The icons are structured in a hierarchical tree, which shows the relation between the application and the GOOSE messages. The upper level (eg. application) assumes always the worst status of the next lower level (eg. one GOOSE-message). Because of this a single faulty GOOSE-message can be detected very fast and simple.

		Configurationfile		
		normal	warning	error
Logfile	normal			
	warning			
	error			

Picture 4: Icons with traffic light character

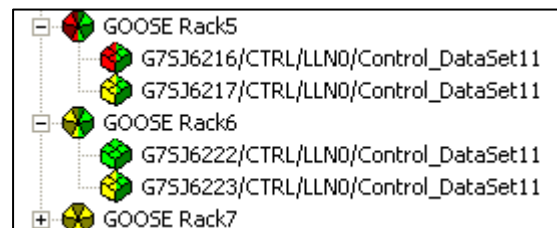

Picture 5: Hierarchical tree

For specialists there is the possibility to set a filter inside SAM, which allows a fast analysis in detail (eg. for a faulty GOOSE-message). It is possible to have access to all packets, which are stored in the ring buffer. The filtered GOOSE-messages will be displayed in the main and detail view window.

Missing	Reference	MAC Sender	TTL	Total	E	W	Stat.Nr.	Seq.Nr	D_TTL	S_TTL	SGM	Reboot
	G6MD6644CTRL/LLN0\$GO\$Control_DataSet7	08:00:06:86:57:4A	3000	8	0	2	0	0	0	1	1	0
	G6MD6641CTRL/LLN0\$GO\$Control_DataSet1	00:0F:BB:07:C5:80	3000	9					0	1	1	0
	G6MD6642CTRL/LLN0\$GO\$Control_DataSet2	00:0F:BB:07:C5:7D	3000	9					0	1	1	0
	G6MD6643CTRL/LLN0\$GO\$Control_DataSet2	00:0F:BB:07:C6:40	3000	9					0	1	1	0

Picture 6: Extract of the GOOSE-monitor and set up of a filter

Integration of the GOOSE Inspector at the stationbus

The connection to the network will be realized via the network interface card of your PC.

If the PC is connected to a normal port of a switch you will receive GOOSE messages automatically. Other network traffic (like client server communication via MMS) will not be received. So your main focus can be the capturing and analysis of GOOSE-messages.

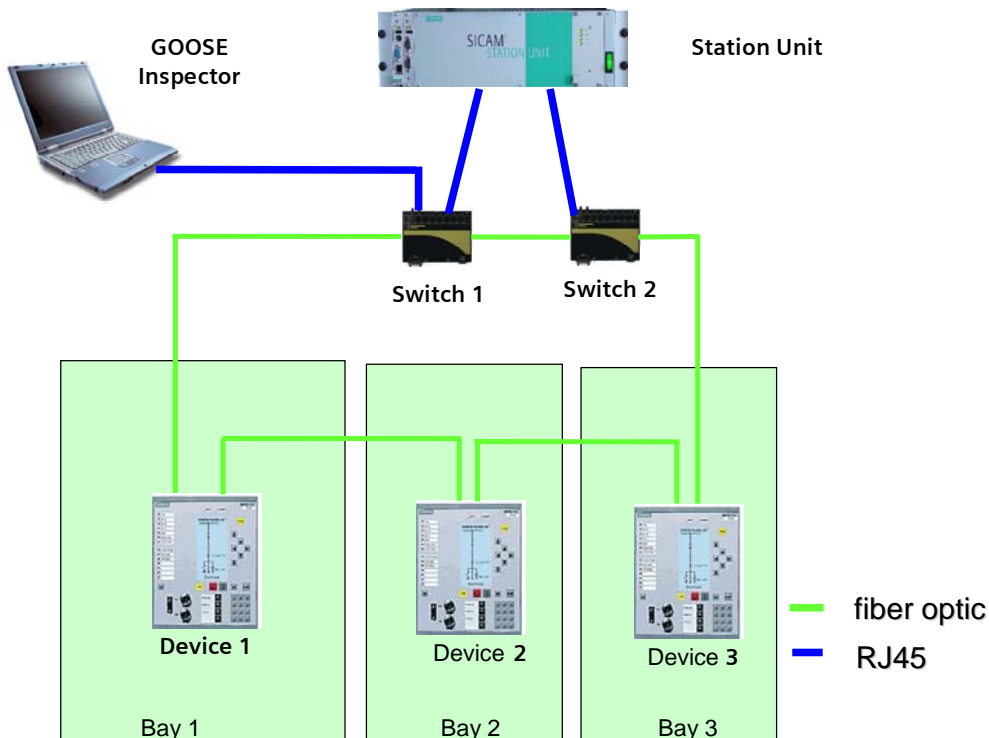

Picture 7: schematic network sketch

Planned new additional functions

The following listed additional functions will be offered to owners of user licenses without any costs.

- Real-time monitoring of dedicated status values (binary tracks)
- Error logs for detailed analysis in long term records
- Event logs

Technical Data

Protocol:

IEC 61850, MMS- and GOOSE-Coding with BER

Included in delivery:

Contains installation CD with USB-dongle and PDF user manual

Supported languages:

English, German

Minimal system requirements:

Windows XP, 32 Bit, SP2 or SP3

CPU at least 1,3 GHz

RAM 500MB

Network interface (Ethernet LAN, TCP/IP)

USB-Port for licence-dongle

Recommended system requirements:

Windows XP, 32 Bit, SP2 or SP3

Duo CPU at least 1,6 GHz

RAM 2 GB

Network interface (Ethernet LAN, TCP/IP)

USB-Port for licence-dongle

Ordering Data

Product Name

GOOSE Inspector

GOOSE Inspector for IEC 61850 Ethernet stationbus

Online-Monitoring of IEC 61850 GOOSE telegrams

licence for one computer

contains Installation CD with USB-dongle and user manual

Order No.:

7XS9 00 - 0AA00

Responsible for technical content:
Markus Spangler, E D EA PRO LM 2
Siemens AG, Nuremberg
Internet: www.SIPROTEC.com

Division: Energy
Energy Automation
PO box 48 06
D-90026 Nuremberg

