

## Introduction

The following application shows an overview, how the different logical nodes describe the different types of switches, which can be realized in IEC 61850 Siprotec 4 devices. An attached IEC 61850 example explains the use of the interlocking feature.

## Explanation of the different logical nodes XCBR, XSWI, CILO, CSWI

### Logical Node XCBR

This LN is used for modeling switches with short circuit breaking capability. Additional logical nodes are required to complete the logical modeling for the breaker being represented. The closing and opening commands are subscribed by the logical node CSWI.

The available data objects of the logical node XCBR are the following:

Data object	Description
Beh	Behaviour (on, off, blocked, test, test-blocked) (read-only) of the logical node
Mod	Mode (on, off, blocked, test, test-blocked) (controllable) of the logical node
Health	Health reflects the state of the logical node related HW and SW (ok, warning, alarm)
NamPlt	This is the name plate of the logical node
Loc	This Data indicates the switchover between local and remote operation
OpCnt	This Data represents a count of operations that is not reset able.
Pos	This Data is accessed when performing a switch command or to verify the switch status or position.
BlkOpn	This Data is used to block 'open operation' from another logical node.
BlkCls	This Data is used to block 'close operation' from another logical node
CBOpCap	This is an enumeration representing the physical capabilities of the breaker to operate. It reflects the switching energy as well as additional blocking due to some local problems. (None, Open, Close-Open, Open-Close-Open, Close-Open-Close-Open)

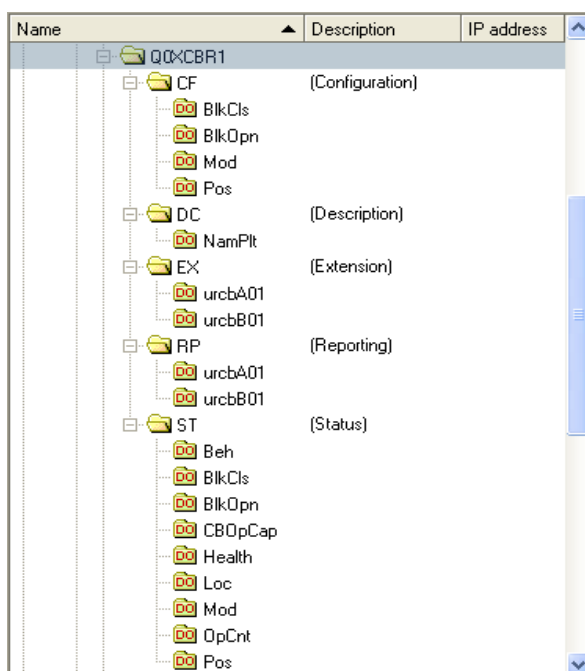

The data objects “urcbA01” and “urcbB01” in the functional constraints “RP” and “EX” are used for unbuffered report control blocks.

Figure 1: Screenshot IEC-Browser, available data objects in the logical node XCBR

## Logical Node XSWI

This LN is used for modeling switches without short circuit breaking capability, for example disconnectors, air break switches and ground switches. Additional logical nodes are required to complete the logical modeling for the switch being represented. The closing and opening commands are subscribed by the logical node CSWI.

The available data objects of the logical node XSWI are the following:

Data object	Description
Beh	Behaviour (on, off, blocked, test, test-blocked) (read-only) of the logical node
Mod	Mode (on, off, blocked, test, test-blocked) (controllable) of the logical node
Health	Health reflects the state of the logical node related HW and SW (ok, warning, alarm)
NamPlt	This is the name plate of the logical node
Loc	This Data indicates the switchover between local and remote operation
OpCnt	This Data represents a count of operations that is not reset able.
Pos	This Data is accessed when performing a switch command or to verify the switch status or position.
BlkOpn	This Data is used to block 'open operation' from another logical node.
BlkCls	This Data is used to block 'close operation' from another logical node
SwTyp	Switch type (Load Break, Disconnector, Earthing Switch, High Speed Earthing Switch)
SwOpCap	This is an enumeration representing the physical capabilities of the switch to operate. It includes additional blocking due to some local problems. (None, Open, Close, Open and Close)

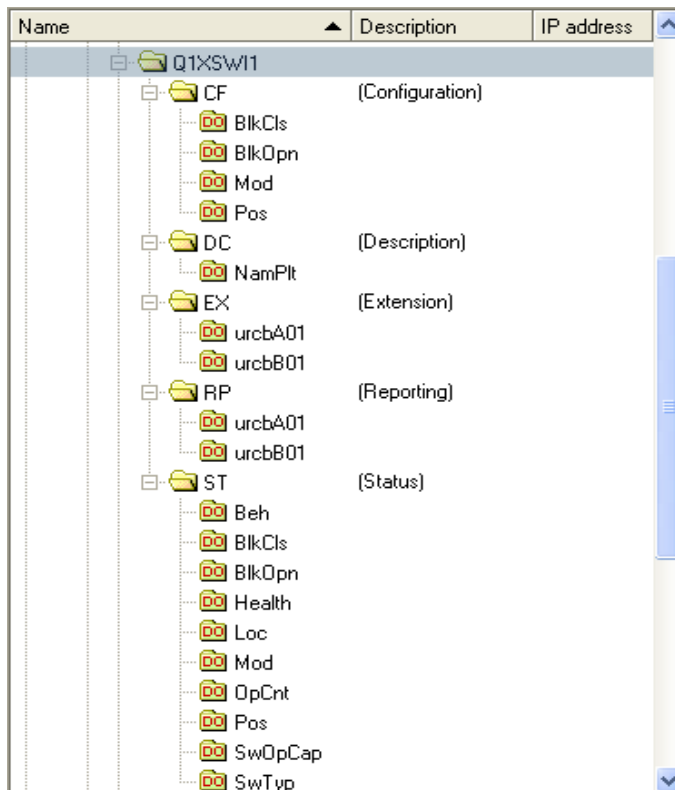

The data objects “urcbA01” and “urcbB01” in the functional constraints “DC” and “EX” are used for unbuffered report control blocks.

Figure 2: Screenshot IEC-Browser, available data objects in the logical node XSWI

### Logical Node CSWI

This logical node is used to control circuit breakers and switches. The data object “Pos” in the functional constraint “CO” will be changed by the Station Unit for operating the switch/circuit breaker. The operation is not possible if the interlocking conditions in the logical node CILO or the data objects “Block Open” and “Block Close” forbid to operate.

The available data objects of the logical node CSWI are the following:

Data object	Description
Beh	Behaviour (on, off, blocked, test, test-blocked) (read-only) of the logical node
Mod	Mode (on, off, blocked, test, test-blocked) (controllable) of the logical node
Health	Health reflects the state of the logical node related HW and SW (ok, warning, alarm)
NamPlt	This is the name plate of the logical node
Loc	This Data indicates the switchover between local and remote operation
Pos	This Data is accessed when performing a switch command or to verify the switch status or position (for command you need FC “Command”, to show position you need FC “Status”).

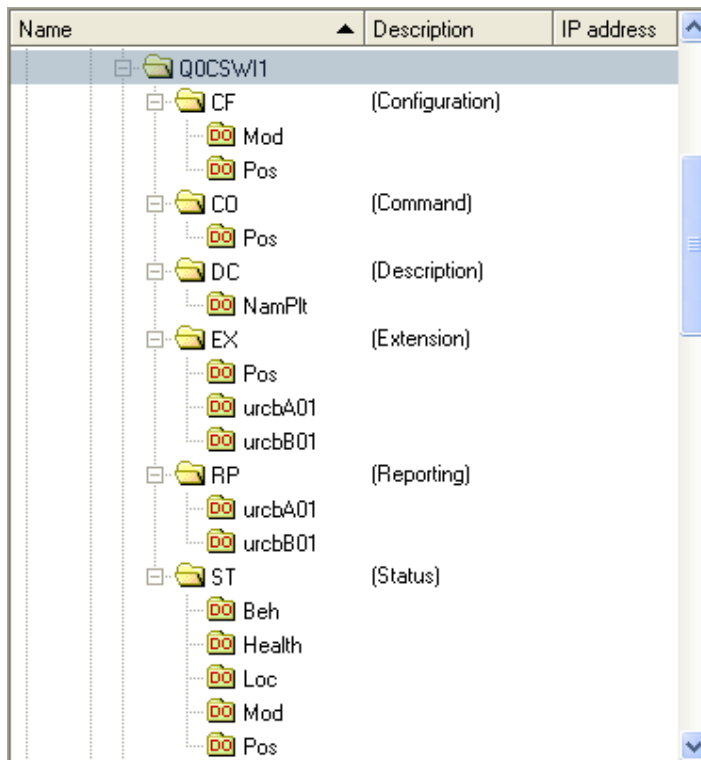

The data objects “urcbA01” and “urcbB01” in the functional constraints “RP” and “EX” are used for unbuffered report control blocks.

Figure 3: Screenshot IEC-Browser, available data objects in the logical node CSWI

## Logical Node CILO

This logical node is used to “enable” a switching operation if the interlocking conditions are fulfilled. One instance per switching device is needed. At least all related switchgear positions have to be subscribed. The interlocking algorithm is a local issue and will be realized in the CFC logic of the SIPROTEC device.

The available data objects of the logical node CSWI are the following:

Data object	Description
Beh	Behaviour (on, off, blocked, test, test-blocked) (read-only) of the logical node
Mod	Mode (on, off, blocked, test, test-blocked) (controllable) of the logical node
Health	Health reflects the state of the logical node related HW and SW (ok, warning, alarm)
NamPlt	This is the name plate of the logical node
EnaOpn	The interlocking function itself determines the status of this data and thus permits the opening of the device when TRUE. The control service checks this value before he controls “Open/Off” a switch.
EnaCls	The interlocking function itself determines the status of this data and thus permits the closing of the device when TRUE. The control service checks this value before he controls “Close/On” a switch.

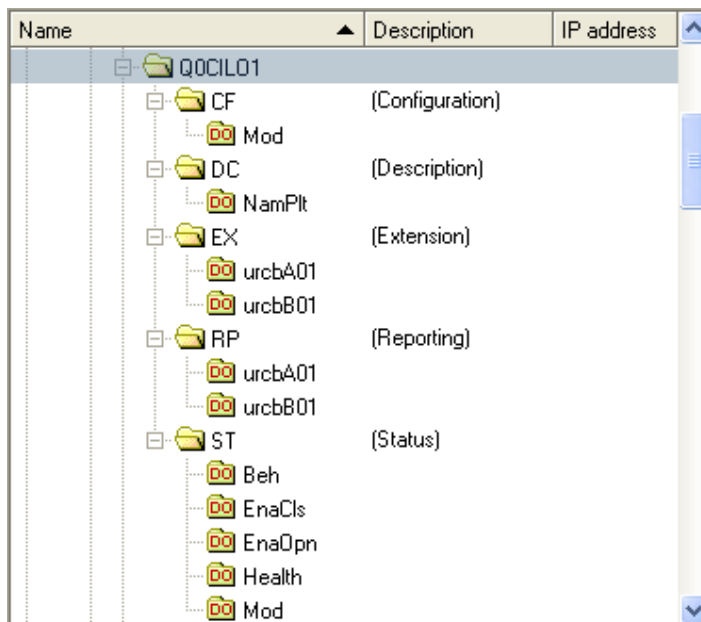

The data objects “urcbA01” and “urcbB01” in the functional constraints “RP” and “EX” are used for unbuffered report control blocks.

Figure 4: Screenshot IEC-Browser, available data objects in the logical node CILO

## Realization in Siprotec devices:

The mapping of the origin SIPROTEC parameter values to the IEC61850 data attributes is described in the PIXIT-file of the dedicated SIPROTEC relay (download of all PIXIT-files is possible at [www.siprotec.com](http://www.siprotec.com)).

The circuit breaker is often named “Q0”, the disconnector “Q1” and the ground switch “Q8” corresponding to German Standard “DIN40719-2”. Therefore these terms are used as the default prefixes for the logical nodes.



signals which are derived via binary inputs. The command as a source for system interface to be operated by a station unit. The feedback as destination “system interface” and “CFC-logic” for further processing.

Two binary inputs for feedback are required for double point indication i.e. if:

- the switch device is opened=off (01)
- the switch device is closed=on (10)
- the switch device is in intermediate / not valid position (either 00 or 11).

Controls without feedback can also be used; in this case interlocking will not be possible. For interlocking the feedback signals are the most important information.

In this example, the interlocking must check the status of the disconnecter (Q1) and the earth switch (Q8) before releasing a close command to the circuit breaker Q0. In picture 6 the CFC chart is shown. The status of the disconnecter and earth switch is decoded with DI\_TO\_BOOL gates.

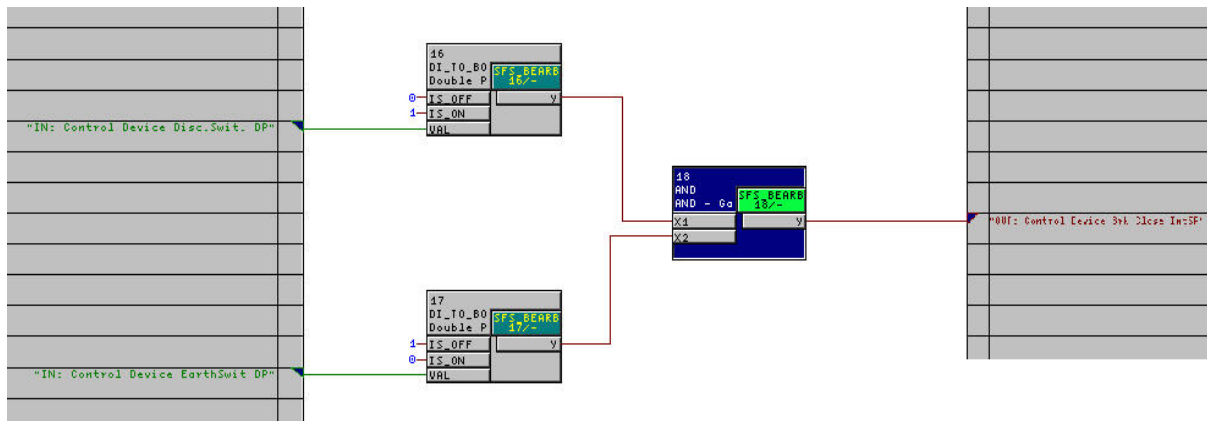

Picture 6: application of interlocking in CFC

The first DI\_TO\_BOOL gate decodes the closed position of the disconnecter switch (Q1). The 2<sup>nd</sup> DI\_TO\_BOOL gate decodes the open position of the ground switch (Q8).

If both these conditions are valid, the AND gate will generate the signal for releasing the circuit breaker close command “Brk Close”.

## Realization of circuit breakers and switches with IEC61850 in SIPROTEC 4 devices

The default settings already contain signals for interlocking (internal single point annunciations, see picture 5). For user defined signals these must first be created in the I/O matrix and routed to source CFC. Otherwise these will not be available for selection later.

Ultimately the interlocking condition of the circuit breaker command must be allocated to the release signal derived with the logic in picture 6 ( see picture 7 ). In the input/output matrix you have to click with the right mouse button on the circuit breaker and choose the *object properties*-item.

The release signal *Control Device Brk Close* is responsible for the switching ON the circuit breaker.

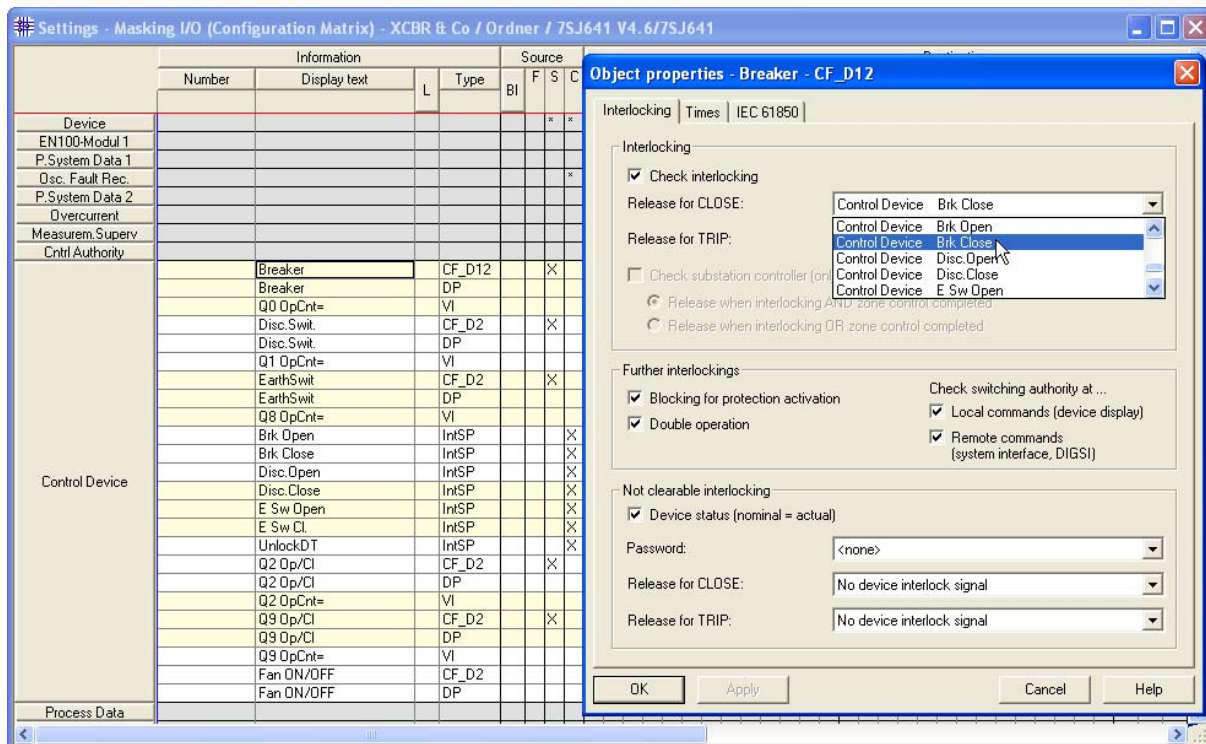

Picture 7: Object properties of the circuit breaker

For the control functions such as circuit breaker OFF or other devices the same procedure must be carried out with the relevant interlocking conditions.

The default settings of SIPROTEC 4 devices always contain a CFC chart with standard interlocking functions.

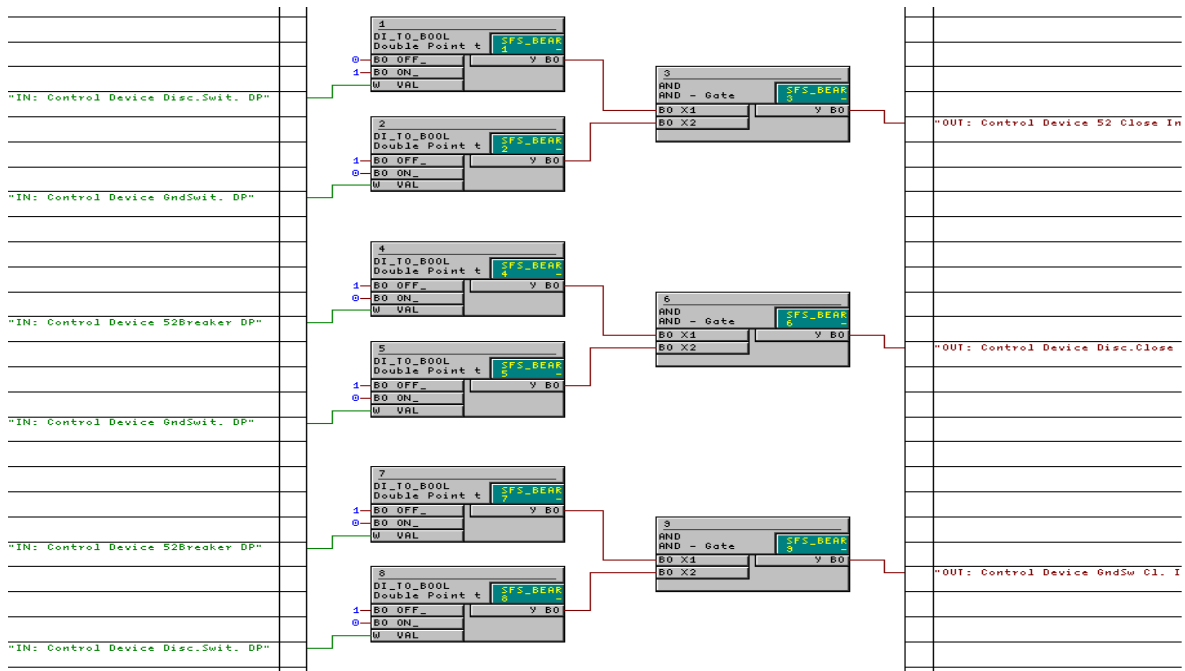

Picture 8: Extended CFC chart for interlocking of several switching devices

To create a logical node XCBR (if necessary) insert a control command in the matrix like in the figure below:

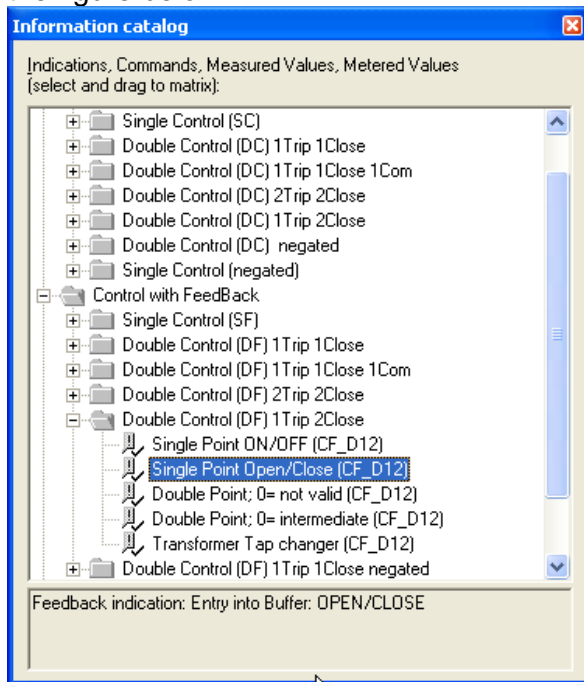

Picture 9: Information catalog for different commands, indications



## Realization of circuit breakers and switches with IEC61850 in SIPROTEC 4 devices

Drag and drop the control command to the matrix. Two lines one for the command and the second one for the feedback appear automatically.

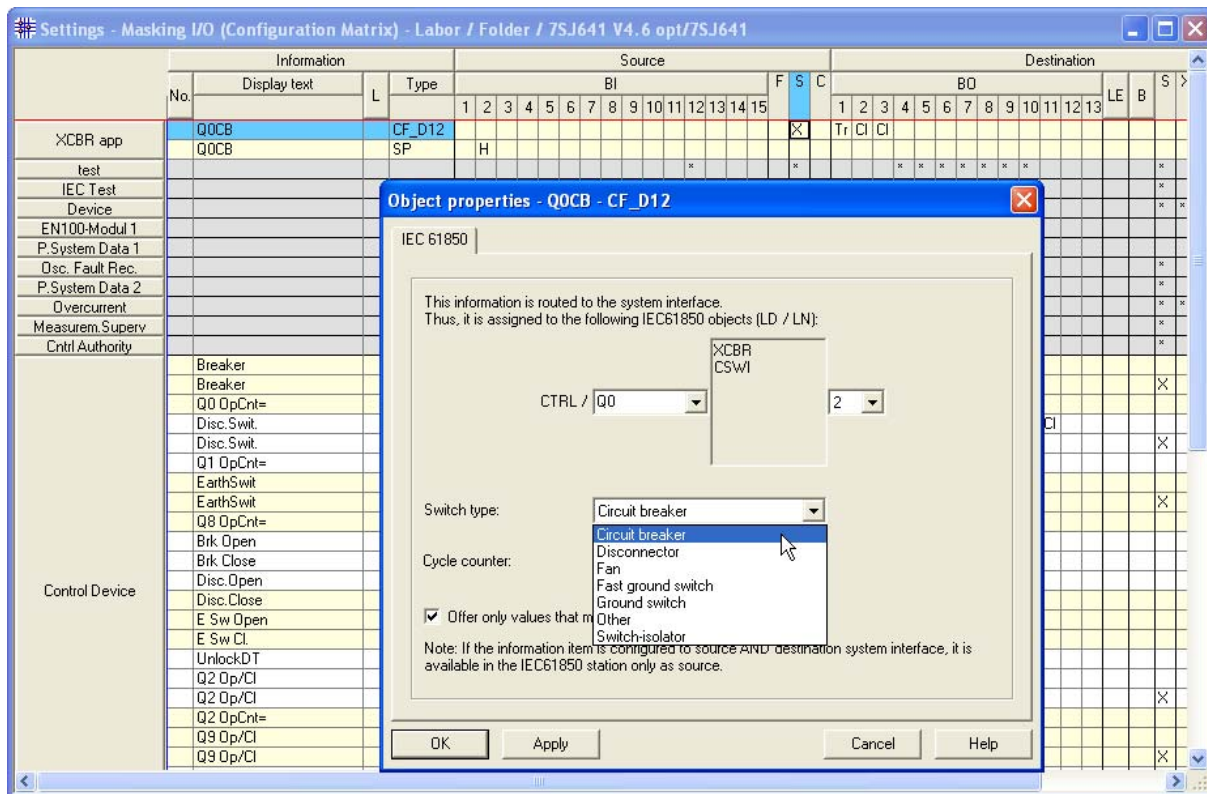

Picture 10: object properties window of the created command for a circuit breaker

Assign the information to the system interface, and then the object property window of this command appears automatically. Choose "Circuit breaker" as the switch type and give the logical node a prefix, e.g. "Q0" and a suffix.

As you can see this choice will automatically assign this control command to the logical nodes XCBR and CSWI (and CILO, but not listed here).

In case of choosing another switch type, e.g. "Disconnecter" the control command will automatically assigned to the logical nodes XSWI and CSWI (and CILO, but not listed here) as well:



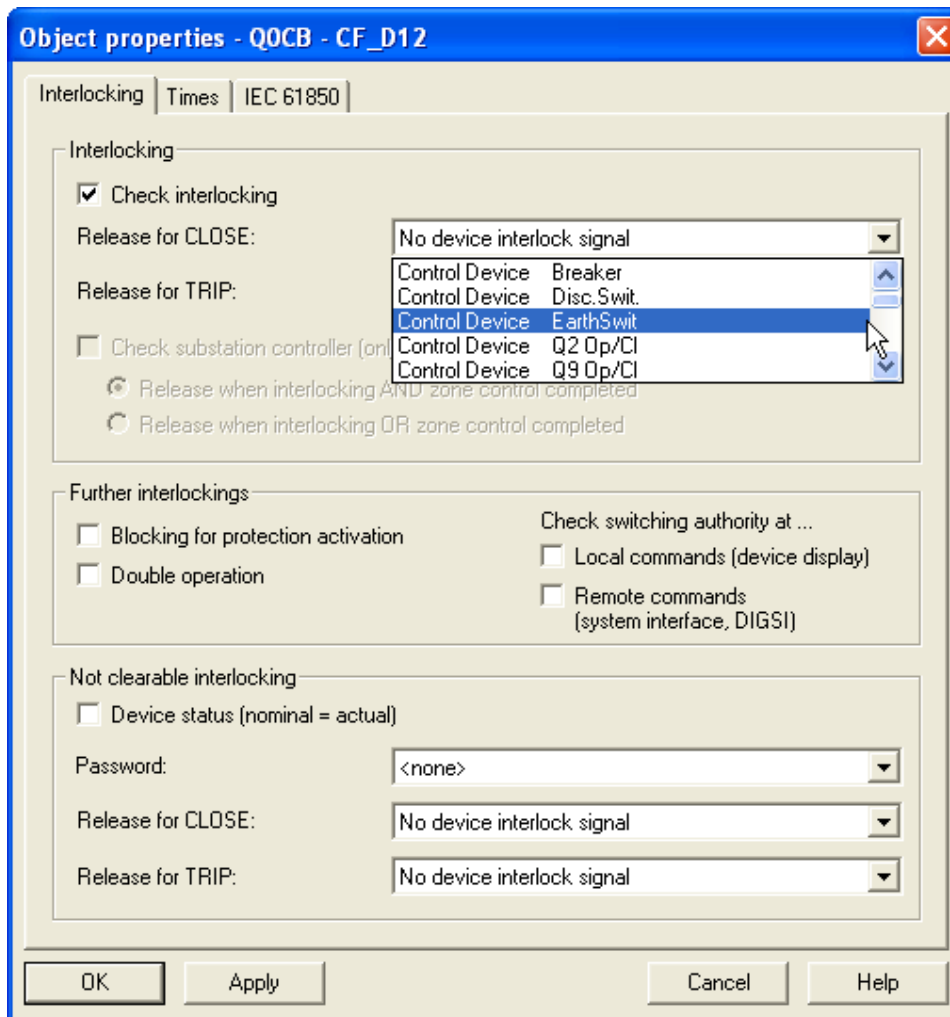

Picture 13: insert the interlocking conditions for the circuit breaker

After updating the information to the IEC 61850 station configurator and updating the SIPROTEC device you can check the configuration.