

# SIEMENS

## SIMATIC



### Industrial PC SIMATIC Rack PC 547B

#### Operating Instructions

<u>Introduction</u>	<b>1</b>
<u>Safety information</u>	<b>2</b>
<u>Description</u>	<b>3</b>
<u>Application planning</u>	<b>4</b>
<u>Mounting</u>	<b>5</b>
<u>Connecting</u>	<b>6</b>
<u>Commissioning</u>	<b>7</b>
<u>Integration</u>	<b>8</b>
<u>Functions</u>	<b>9</b>
<u>Expansions and configuration</u>	<b>10</b>
<u>Maintenance and service</u>	<b>11</b>
<u>Troubleshooting/FAQs</u>	<b>12</b>
<u>Specifications</u>	<b>13</b>
<u>Dimension drawings</u>	<b>14</b>
<u>Detailed descriptions</u>	<b>15</b>
<u>Appendix</u>	<b>A</b>
<u>ESD directives</u>	<b>B</b>
<u>List of abbreviations/acronyms</u>	<b>C</b>

## Safety Guidelines

This manual contains notices you have to observe in order to ensure your personal safety, as well as to prevent damage to property. The notices referring to your personal safety are highlighted in the manual by a safety alert symbol, notices referring only to property damage have no safety alert symbol. These notices shown below are graded according to the degree of danger.

 <b>DANGER</b>
indicates that death or severe personal injury <b>will</b> result if proper precautions are not taken.
 <b>WARNING</b>
indicates that death or severe personal injury <b>may</b> result if proper precautions are not taken.
 <b>CAUTION</b>
with a safety alert symbol, indicates that minor personal injury can result if proper precautions are not taken.
<b>CAUTION</b>
without a safety alert symbol, indicates that property damage can result if proper precautions are not taken.
<b>NOTICE</b>
indicates that an unintended result or situation can occur if the corresponding information is not taken into account.

If more than one degree of danger is present, the warning notice representing the highest degree of danger will be used. A notice warning of injury to persons with a safety alert symbol may also include a warning relating to property damage.

## Qualified Personnel

The device/system may only be set up and used in conjunction with this documentation. Commissioning and operation of a device/system may only be performed by **qualified personnel**. Within the context of the safety notes in this documentation qualified persons are defined as persons who are authorized to commission, ground and label devices, systems and circuits in accordance with established safety practices and standards.

## Prescribed Usage

Note the following:

 <b>WARNING</b>
This device may only be used for the applications described in the catalog or the technical description and only in connection with devices or components from other manufacturers which have been approved or recommended by Siemens. Correct, reliable operation of the product requires proper transport, storage, positioning and assembly as well as careful operation and maintenance.

## Trademarks

All names identified by ® are registered trademarks of the Siemens AG. The remaining trademarks in this publication may be trademarks whose use by third parties for their own purposes could violate the rights of the owner.

## Disclaimer of Liability

We have reviewed the contents of this publication to ensure consistency with the hardware and software described. Since variance cannot be precluded entirely, we cannot guarantee full consistency. However, the information in this publication is reviewed regularly and any necessary corrections are included in subsequent editions.

# Table of contents

<b>1</b>	<b>Introduction</b> .....	<b>7</b>
1.1	Preface.....	7
1.2	Guideline to the operating instructions .....	8
<b>2</b>	<b>Safety information</b> .....	<b>9</b>
2.1	General safety instructions .....	9
<b>3</b>	<b>Description</b> .....	<b>11</b>
3.1	Overview .....	11
3.2	Areas of application .....	12
3.3	Highlights .....	12
3.4	Function .....	13
3.5	Features .....	14
3.6	Design .....	17
3.6.1	External structure.....	17
3.6.2	Operator Controls .....	18
3.6.3	Connection components .....	19
3.6.4	Status indicators .....	21
<b>4</b>	<b>Application planning</b> .....	<b>23</b>
4.1	Transport.....	23
4.2	Unpacking and checking the delivery unit .....	23
4.3	Ambient and environmental conditions.....	25
4.4	Access protection.....	26
<b>5</b>	<b>Mounting</b> .....	<b>27</b>
5.1	Installing the device .....	27
<b>6</b>	<b>Connecting</b> .....	<b>29</b>
6.1	Connecting peripherals .....	29
6.2	Connecting the device to power.....	30
6.3	Equipotential bonding .....	33
<b>7</b>	<b>Commissioning</b> .....	<b>35</b>
7.1	Requirements for commissioning.....	35
7.2	Initial Commissioning - Initial Startup.....	35
7.3	Windows XP, Vista Security Center.....	36
7.4	Notes on operation.....	37
7.4.1	DVD burner .....	37

7.4.2	Removable hard disks.....	38
7.4.3	2HDD system (optional).....	40
7.4.4	RAID system .....	41
<b>8</b>	<b>Integration.....</b>	<b>49</b>
8.1	Integration .....	49
<b>9</b>	<b>Functions.....</b>	<b>51</b>
9.1	Overview of the monitoring functions.....	51
9.2	Temperature monitoring/display .....	52
9.3	Watchdog (WD).....	52
9.4	Fan monitoring .....	53
9.5	Monitoring software.....	53
<b>10</b>	<b>Expansions and configuration.....</b>	<b>55</b>
10.1	Opening the device .....	55
10.2	Memory expansion.....	58
10.3	Installing expansion cards.....	58
10.3.1	Notes on the modules .....	58
10.3.2	Installing an expansion module.....	59
10.4	Installing drives .....	60
10.4.1	Options of installing disk drives.....	60
10.4.2	Installing and removing a disk drive or removable rack.....	61
10.4.3	Installing and removing a hard disk .....	63
<b>11</b>	<b>Maintenance and service.....</b>	<b>65</b>
11.1	Removing and installing hardware components .....	65
11.1.1	Repairs.....	65
11.1.2	Replacing filters.....	66
11.1.3	Removing the device fan.....	67
11.1.4	Replacing the backup battery .....	69
11.1.5	Removing the power supply module.....	70
11.1.6	Removing the motherboard.....	71
11.1.7	Processor replacement .....	72
11.2	Reinstalling the software .....	74
11.2.1	General installation procedure .....	74
11.2.2	Restoring the Factory State of the Software Using the Restore DVD .....	75
11.2.3	Installing Windows .....	76
11.2.3.1	Setting up partitions for Windows 2000, XP, Server 2003 operating systems .....	77
11.2.3.2	Installing Microsoft Windows operating systems .....	79
11.2.4	Setting up the language selection for Windows 2000 MUI .....	80
11.2.5	Language selection on Windows XP Professional and Windows Server 2003.....	81
11.2.6	Recovery of Windows Vista .....	82
11.2.7	Installing drivers and software .....	85
11.2.8	Installing the RAID Controller software.....	85
11.2.9	Installing burner/DVD software .....	85
11.2.10	Installing updates .....	86
11.2.10.1	Updating the operating system .....	86
11.2.10.2	Installing or updating application programs and drivers .....	86
11.2.11	Data backup.....	87
11.2.11.1	Creating an image.....	87

<b>12</b>	<b>Troubleshooting/FAQs</b> .....	<b>89</b>
12.1	General problems .....	89
12.2	Problems when using modules of third-party manufacturers .....	91
<b>13</b>	<b>Specifications</b> .....	<b>93</b>
13.1	General specifications.....	93
13.2	Power requirements of components (maximum values) .....	97
13.3	AC voltage supply .....	97
13.4	Technical data of the telescopic rails .....	98
<b>14</b>	<b>Dimension drawings</b> .....	<b>99</b>
14.1	Dimensional drawing of the device .....	99
14.2	Dimensional drawing for the use of telescopic rails.....	100
14.3	Dimensional drawings for the installation of expansion modules .....	101
<b>15</b>	<b>Detailed descriptions</b> .....	<b>103</b>
15.1	Motherboard.....	103
15.2	System resources .....	103
15.3	Interrupt assignments .....	104
15.4	BIOS Setup .....	107
<b>A</b>	<b>Appendix</b> .....	<b>109</b>
A.1	Guidelines and declarations.....	109
A.2	Certificates and Approvals .....	110
A.3	Service and support .....	112
A.4	Retrofitting instructions .....	113
<b>B</b>	<b>ESD directives</b> .....	<b>115</b>
B.1	ESD guidelines .....	115
<b>C</b>	<b>List of abbreviations/acronyms</b> .....	<b>117</b>
C.1	Abbreviations .....	117
	<b>Glossary</b> .....	<b>123</b>
	<b>Index</b> .....	<b>133</b>



# Introduction

## 1.1 Preface

### Purpose of this documentation

These operating instructions contain all the information you need to commission and use the SIMATIC Rack PC 547B.

It is intended both for programming and testing/debugging personnel who commission the device itself and connect it with other units (automation systems, further programming devices), as well as for service and maintenance personnel who install expansions or carry out fault/error analyses.

### Scope of validity of this document

This documentation is valid for all variants of the SIMATIC Rack PC 547B and describes the device shipped as of December 2007.

### Position in the information landscape

These operating instructions are available on the supplied "Documentation and Drivers" CD.

For supplementary instructions on how to handle the software, please refer to the corresponding manuals.

### Conventions

The term Rack PC or device is also used within this documentation as abbreviation of the product name SIMATIC Rack PC 547B.

### History

Currently released versions of these operating instructions:

Version	Comments
07/2007	First edition
12/2007	<ul style="list-style-type: none"> <li>• Remedy</li> <li>• New operating system: Windows Vista</li> </ul>

## 1.2 Guideline to the operating instructions

Organization of contents	Contents
Table of contents	Organization of the documentation, including the index of pages and chapters
Introduction	Purpose, layout and description of the important topics.
Safety information	Covers all general safety-related aspects of statutory regulations in terms of the installation, commissioning and operation of the product/system.
Description	Fields of application, the features and the design of the product/system
Application planning	Aspects of storage, transport, environmental and EMC conditions to be considered in the preparatory stage
Mounting	Product installation options and installation instructions
Connecting	Options of connecting the product and connection instructions
Commissioning	Commissioning the product/system.
Integration	Options of integrating the product into existing or planned system environments/networks
Functions	Monitoring and display functions
Expansions / programming	Installation of expansion devices (memory, modules, drives)
Maintenance and service	Replacement of hardware components, restoring and setup of the operating system, installation of drivers and software
Troubleshooting	Problems, cause, remedy
Specifications	General specifications in compliance with relevant standards and current/voltage values
Dimension drawings	Dimensions of the device and of modules
Detailed descriptions	Design, function and features of the vital components, allocation of system resources and use of the BIOS Setup
Appendix	Guidelines and certifications, service and support, notes on retrofitting
ESD directives	General ESD guidelines.



## Safety information

### 2.1 General safety instructions

 <b>CAUTION</b>
Please observe the safety instructions on the back of the cover sheet of this documentation. You should not expand your device unless you have read the relevant safety instructions.

This device is compliant with the relevant safety measures to IEC, EN, VDE, UL, and CSA. If you have questions about the validity of the installation in the planned environment, please contact your service representative.

#### Repairs

Only authorized personnel are permitted to repair the device.

 <b>WARNING</b>
Unauthorized opening and improper repairs can cause considerable damage to property or danger for the user.

#### System expansions

Only install system expansion devices designed for this device. The installation of other expansions can damage the system and violate the radio-interference suppression regulations. Contact your technical support team or where you purchased your PC to find out which system expansion devices may safely be installed.

<b>CAUTION</b>
If you install or exchange system expansions and damage your device, the warranty becomes void.

### Battery

This device is equipped with a Lithium battery. Batteries may only be replaced by qualified personnel.

 <b>CAUTION</b>
There is the risk of an explosion if the battery is not replaced as directed. Replace only with the same type or with an equivalent type recommended by the manufacturer. Dispose of used batteries in accordance with local regulations.

 <b>WARNING</b>
Risk of explosion and release of harmful substances! For this reason, do not burn lithium batteries, do not solder on the cell body, do not open, do not short circuit, do not reverse polarity, do not heat above 100°C, dispose of correctly, and protect against direct sunlight, dampness and dew.

### ESD directives

Modules containing electrostatic sensitive devices (ESDs) can be identified by the following label:



Strictly follow the guidelines mentioned below when handling modules which are sensitive to ESD:

- Always discharge your body's static electricity before handling electrostatic sensitive devices (for example, by touching a grounded object).
- All devices and tools must be free of static charge.
- Always pull the mains connector and disconnect the battery before you install or remove modules which are sensitive to ESD.
- Handle modules fitted with ESDs by their edges only.
- Do not touch any wiring posts or conductors on modules containing ESDs.

## Description

### 3.1 Overview

The SIMATIC Rack PC 547B is a powerful industrial PC in 19" rack format design (4HE). It is perfectly suited for high-performance industrial PC applications.

- Maximum performance
- Attractive price



Figure 3-1 SIMATIC Rack PC 547B

## 3.2 Areas of application

The SIMATIC Rack PC 547B offers system integrators, cabinet designers, system engineers and machine designers a 19" rack PC platform for high-performance IT applications on the control and cell levels. It can be used for:

- Process and visualization applications
- Industrial image processing
- Quality assurance / surveillance tasks
- Measurement, control and rule-based tasks
- Data acquisition and management

The SIMATIC Rack PC 547B has CE certification for use in the industrial sector as well as in residential and commercial areas, and small businesses. In addition to the industrial applications, it can also be used in building services automation or in facilities open to the public.

## 3.3 Highlights

### Highlights

#### Latest PC technology:

- State-of-the-art Intel technology
- High performance and scalability
- PCI-, PCIe x1-, PCIe x16 slots

#### Industrial suitability:

- Dust protection
- Service-friendly
- CE certification for industrial and office use
- Transport safety for expansion cards
- Monitoring functions

#### Investment security:

- Guaranteed spare parts availability for at least 3 years

#### High system availability:

- SIMATIC PC DiagMonitor - PC diagnostics / message software via OPC/SNMP/LAN
- Preventative data backup with the SIMATIC PC/PG Image Creator
- RAID1 – redundant data storage on two hard drives, also "hot swap" in connection with SATA mounting frames.

## 3.4 Function

- Integrated, assigned monitoring functions
  - Fan speed (CPU, power supply and front fan)
  - Temperature (case, processor)
  - Program execution (watchdog)
- RAID1 for automatic data mirroring of two serial ATA hard drives
- Enhanced diagnostic/messaging by way of Ethernet, E-mail, SMS, and for direct input in SIMATIC software by way of OPC (optional using SIMATIC PC DiagMonitor):
  - Operating hours counter
  - Hard disk status
  - System status (Heart Beat)
  - Automatic logging of all messages to a log file
  - Option of remote monitoring of networked SIMATIC PCs

## 3.5 Features

General features	
Design	<ul style="list-style-type: none"> <li>• 19" rack, 4 HU</li> <li>• Robust full metal rack design case, lacquered outside and coated inside</li> <li>• Prepared for mounting telescopic rails</li> <li>• Horizontal and vertical mounting position is possible</li> <li>• Tower installation by means of Tower Kit</li> <li>• Lockable front cover as access protection</li> </ul>
Enclosure	<ul style="list-style-type: none"> <li>• Dust protection by means of overpressure ventilation using bearing seated front fan through filter</li> <li>• Card retainer for reliable operation of PC modules under vibration and shock conditions</li> </ul>
Drive bays	<ul style="list-style-type: none"> <li>• Front: 3 x 5.25" and 1 x 3.5"</li> <li>• Internal: 2x 3.5"</li> </ul>
Slots for expansion cards	<ul style="list-style-type: none"> <li>• 4 x PCI long</li> <li>• 2 x PCIe x1 long</li> <li>• 1 x PCIe x16 long</li> </ul>
Graphics	<ul style="list-style-type: none"> <li>• Intel® GMA950 on-board graphics controller 2-D and 3-D engine integrated in chipset, Dynamic Video Memory Technology (uses up to 224 MB of RAM) Max. 1280x1024 at 100 Hz / 32-bit color depth Max. resolution: 2048x1536 at 75 Hz / 16-bit color depth</li> <li>• in PCIe x16 slot (optional) PCIe x16 graphic card (dual head: 2 x VGA or 2 x DVI), 128 MB RAM Up to 2048x1536 pixels at 75 Hz / 32-bit color depth</li> </ul>
<b>Ports</b>	
Ethernet	1 x 10/100/1000 Mbps (RJ45)
USB	4 x front, 2 x back; high-current
Serial	COM1 (V.24), COM2 (V.24) optional
Parallel	LPT1
Graphics	1 x VGA
Keyboard	1 x PS/2
Mouse	1 x PS/2
Audio	Mic in, Line in, Line out
Power supply	100 - 230 V AC, wide range; with short-term buffering against power failure: Max. 16 ms at 0.85 rated voltage

Watchdog functions	
Temperature	<ul style="list-style-type: none"> <li>Overshoot/undershoot of permissible operating temperature</li> </ul>
Fans	<ul style="list-style-type: none"> <li>RPM monitoring, wear monitoring</li> </ul>
Watchdog	<ul style="list-style-type: none"> <li>Monitoring of program execution</li> <li>Monitoring time can be parameterized in software</li> <li>Restart can be parameterized in the event of a fault</li> </ul>
Status LEDs	<ul style="list-style-type: none"> <li>POWER (internal power supply unit, PC switched On)</li> <li>HARDDISK (access to hard disk)</li> <li>STATUS (temperature and fan status)</li> </ul>

Standard versions	
Processor	Intel® Core™ 2 Duo E6600 (2.4 GHz, 1066 MHz FSB, 4 MB L2C, EM64T, VT)
RAM expansion	512 MB SDRAM DDR2 667 (PC2 5300) Single channel 4 DIMM slots for maximum 4 GB
Disk drives	
Floppy disk drive	1.44 MB
3.5" hard disk (SATA)	250 GB, built in
Operating system	None

Optional accessories	
Processor	<ul style="list-style-type: none"> <li>Intel® Core™ 2 Duo E4300 (1.8 GHz, 800 MHz FSB, 2 MB L2C, EM64T)</li> <li>Intel® Celeron® 440 (2.0 GHz, 800 MHz FSB, 512 KB L2C)</li> </ul>
RAM expansion	Up to 4 GB, dual-channel
Disk drives	
DVD-ROM	Read: DVD ROM: Single layer 16x, Dual Layer 8x DVD+R/RW, DVD-R/RW 8x, DVD-RAM 2x CD-ROM, CD-R 32x, CD-RW 20x
DVD burner	Read: DVD ROM: Single Layer 16x, Dual Layer 12x DVD-R/+R: Single Layer 16x, Dual Layer 7x DVD-RW/+RW 13x CD-ROM/CD-R 48x, CD-RW 40x Writing: DVD+R 18x, DVD+RW 8x, DVD-R 18x, DVD-RW 6x, DVD+R9 (DL) 8x, DVD-R DL 8x CD-R 48x, CD-RW 32x

Optional accessories	
Hard disks 3.5" (SATA)	<ul style="list-style-type: none"> <li>• 2x 250 GB</li> <li>• 1x or 2x 120 GB SATA; 3.5", in removable cartridges</li> <li>• RAID1; 3.5" (mirrored drives) built in</li> <li>• RAID1; 3.5" (mirrored drives) in "hot swap" removable cartridges</li> </ul>
Graphics controllers	PCIe x16 graphics adapter, Dual Head (2x VGA or 2x DVI)
Operating system	Preinstalled / supplied on Restore DVD <ul style="list-style-type: none"> <li>• Windows 2000 Professional MUI*</li> <li>• Windows XP Professional MUI*</li> <li>• Windows Server 2003 including 5Client MUI*</li> </ul> *MUI: <b>M</b> ulti language <b>U</b> ser <b>I</b> nterface; 5 languages (German, English, French, Spanish, Italian)

Languages that can be installed from recovery CD / DVD				
Language	Windows 2000	Windows XP	Windows Server 2003	Windows Vista
German	X	X	X	X
English	X	X	X	X
French	X	X	X	X
Italian	X	X	X	X
Spanish	X	X	X	X
Japanese		X	X	X
Chinese Hong Kong		X		X
Chinese (simplified)		X	X	
Chinese Taiwan				X
Korean		X		

Optional expansions	
SIMATIC PC DiagMonitor software	Software tool for monitoring SIMATIC PCs both locally and remote: <ul style="list-style-type: none"> <li>- Watchdog</li> <li>- Temperature</li> <li>- Fan speed</li> <li>- Hard disk monitoring (SMART, RAID Status)</li> <li>- System/Ethernet monitoring (heartbeat)</li> </ul>
SIMATIC PC Image Creator software	Software tool for saving data locally



## 3.6 Design

### 3.6.1 External structure

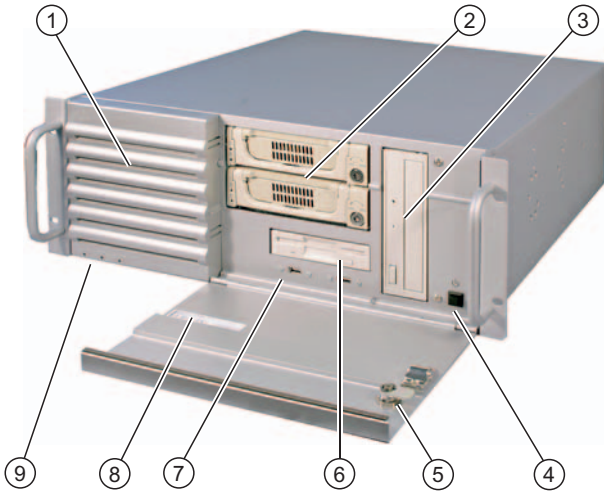
Front view of the device	Pos	Description
	(1)	Front panel with aperture for ventilation of the device (filter mat and fan are located behind this front panel)
	(2)	Installation options for DVD ROM drives, DVD burners and removable drive cartridges
	(3)	Installation options for DVD ROM drives, DVD burners
	(4)	On/off button
	(5)	Front door with lock, provides protection against dirt and unauthorized access. Keep the front door closed during normal operation.
	(6)	Diskette drive
	(7)	USB ports
	(8)	Rating plate
	(9)	Status displays

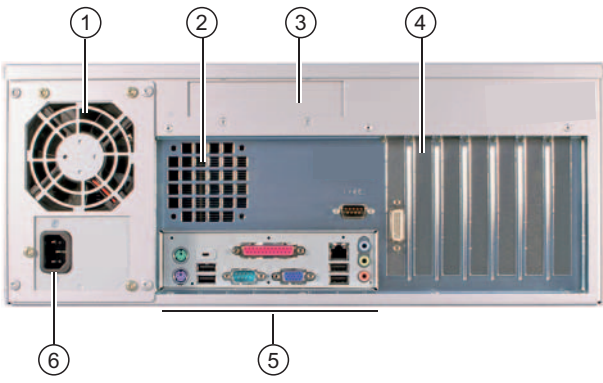
Rear view of the device	Pos	Description
	(1)	Power unit fan
	(2)	Fan aperture Installation option for 60 mm fan
	(3)	Blanking panel Option for installing a cover for external ports
	(4)	Expansion slots 4 x PCI, 2x PCIe x1, 1x PCIe x16
	(5)	Connection elements
	(6)	Power supply connection

### 3.6.2 Operator Controls

Operator control on/off button	Pos	Description
	(1)	The on/off/reset buttons have three functions: <ul style="list-style-type: none"><li>- Switch on the PC (press briefly 1x)</li><li>- Shut down the operating system and PC (press briefly 1x)</li><li>- Switch off the PC without shutting down the operating system (press and hold more than 4 seconds) = hardware reset.</li></ul>

**CAUTION**

Data may be lost when the PC performs a hardware reset.

 **WARNING**

The on/off button signal does not cut off power to the PC!

### 3.6.3 Connection components

#### Ports

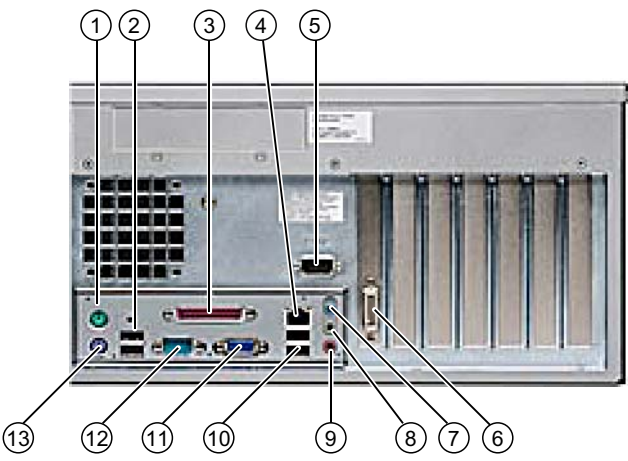
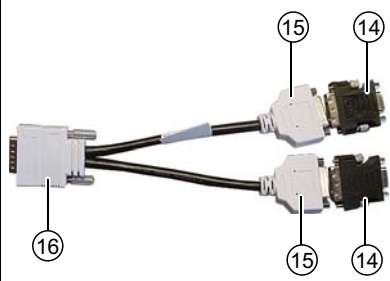
Port location at the rear of the device		
		
Pos	Description	Description
(1)	MOUSE	Connection for a PS/2 mouse
(2)	USB C and D	Connection for USB devices
(3)	LPT	Parallel port, 25-pin
(4)	LAN	RJ 45 Ethernet connection 10/100/1000 Mbps
(5)	COM 2	Serial port 2 (V.24), 9-pin D-sub connector (optional)
(6)	DMS59 connector	DMS59 interface socket of the dual-head graphics card (optional)
(7)	Micro (input)	Microphone connection
(8)	Audio (output)	Headphone connection
(9)	Audio (input)	Connector for analog audio source (Line in)
(10)	USB A and B	Connection for USB devices
(11)	VGA	Connection for VGA monitor
(12)	COM 1	Serial port 1 (V.24), 9-pin D-sub connector
(13)	KEYBOARD	Connection for a PS/2 keyboard
(14)	VGA	VGA connection
(15)	DVI-I	DVI-I connection
(16)	Dual-head adapter	Connector on dual-head graphics card (optional)

### Power supply

Position of the IEC power connector	Description
 A close-up photograph of the IEC power connector on the back of a device. The connector is a standard three-pronged AC power inlet, mounted on a light-colored metal panel. It is surrounded by four screws. Above the connector, a portion of a cooling fan is visible.	IEC connector for the AC power supply to the device. The maximum permitted power range is 120 to 240 V AC.

### 3.6.4 Status indicators

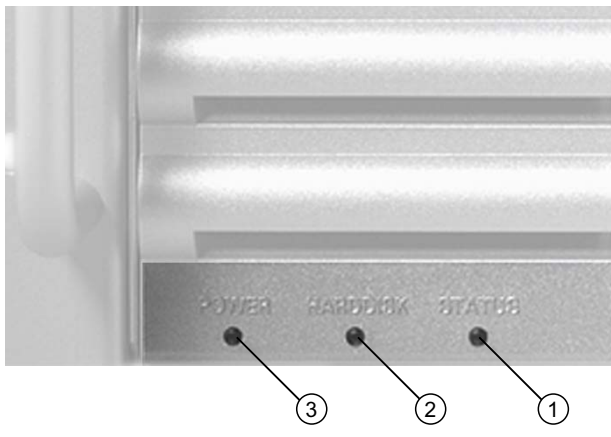
Status displays				
				
Pos	Display	Meaning	LEDs	Description
(1)	STATUS	Fan/temperature status	OFF RED	<ul style="list-style-type: none"> <li>No error</li> <li>Temperature critical (CPU, device temperature).</li> <li>CPU heat sink fan fault</li> <li>Enclosure fan fault</li> <li>Power supply fan fault</li> </ul>
(2)	HARDDISK	Display for hard disk access	OFF GREEN	<ul style="list-style-type: none"> <li>No access</li> <li>Access</li> </ul>
(3)	POWER	PC operating status display	OFF YELLOW GREEN	<ul style="list-style-type: none"> <li>Hibernate, switched off or unplugged</li> <li>Windows standby</li> <li>PC in operation</li> </ul>



## Application planning

### 4.1 Transport

Despite the device's rugged design, its internal components are sensitive to severe vibrations or shock. You must therefore protect the PC from severe mechanical stress when transporting it.

You should always use the **original packaging** for shipping and transporting the device.

#### CAUTION

##### **Risk of damage to the device!**

When transporting the PC in cold weather, it may be submitted to extreme variations in temperature. In this situation, ensure that no moisture (condensation) develops on or inside the device.

If condensation develops, wait at least 12 hours before switching on the device.

### 4.2 Unpacking and checking the delivery unit

#### Unpacking the device

Note the following points when you unpack the unit

- It is advisable not to dispose of the original packing material. Keep it in case you have to transport the unit again.
- Please keep the documentation in a safe place. It is required for initial commissioning and is part of the device.
- Check the delivery unit for any signs of visible transport damage.
- Verify that the shipment contains the complete unit and your separately ordered accessories.
- Please inform your local dealer of any disagreements or transport damages.
- Please inform Siemens AG by means of the enclosed SIMATIC IPC/PG quality control report form.

**Noting the device identification data**

The device can be identified uniquely with the help of these numbers in case of repairs or theft.

Enter the following data in the table below:

- Serial number: The serial number (S VP) is located on the rating plate inside the front door.

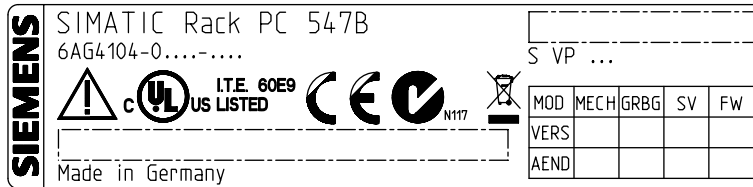

Figure 4-1 Rating plate

- Order number of the device
- Ethernet address: The Ethernet address of the device is available in BIOS Setup (F2 function key), at Info > (F1 function key) > LAN Address.
- Microsoft Windows "Product Key" on the "Certificate of Authenticity" (COA). The COA label is attached to the inside of the front door. You may need the Product Key in case you reinstall the operating system.



Figure 4-2 COA label

Serial number	S VP ...
<input type="checkbox"/> Order no.	6AG4104-0 ...
Microsoft Windows Product Key	
Ethernet address	

**Device equipment**

You will find a list of device equipment on a label behind the front door.



## 4.3 Ambient and environmental conditions

When you plan your project, you should make allowances for:

- The climatic and mechanical environmental conditions specified in the specifications provided by your operating instructions.
- Avoid extreme ambient conditions as far as possible. Protect your PC from dust, moisture, and heat.
- The device has been designed for usage in a normal industrial environment according to IEC 60721-3-3 (pollutant class 3C2 for chemical influence, 3S2 for sand and dust). SIMATIC Rack PCs may not be used in severe operating environments, for example locations with acidic vapors or gasses, without additional protective measures (such as the provision of clean air).
- Keep the PC out of direct sunlight.
- Mount the PC as safely as possible to prevent danger (for example, of falling over).
- The device conforms to protection class IP 30 at the front panel.
- The clearance in the area of the ventilation slots must be at least 50 mm, so that the PC is sufficiently ventilated.
- Do not cover the vent slots of the device.
- The device enclosure satisfies fire protection requirements to EN 60950. It may therefore be installed without additional fire-proofing measures.
- The connected or added peripherals must not introduce a counter emf greater than 0.5 V into the device.

 **WARNING**

If these conditions are not upheld while mounting the system, the approvals according to UL 60950, EN 60950 are forfeited and there is a danger of overheating and personal injury.

## **4.4 Access protection**

The access protection of the Rack PC exists only when the front panel is closed and no keyboards with an On/Off button (power button) are being used.

---

### **Note**

In Windows, you have the option of setting the function of the On/Off button to meet your requirements. You can make these setting in the "Power Options" menu.

---

## Mounting

### 5.1 Installing the device

#### Optional mounting locations

The device can be mounted in control desks, switching cabinets and 19" rack systems, both horizontally and vertically.

#### Optional mounting methods

The device can be mounted with the following methods

- Mounting with cabinet brackets
- Mounting on device bases
- Tower installation: a separate tower kit can be ordered for tower installation (not available in some countries).
- Mounting on telescopic rails  
These telescopic rails allow you to fully extract the device out of the cabinet or rack. Refer to the sections "Technical data of the telescopic rails" and "Dimensional drawing for the use of telescopic rails" for more detailed information.

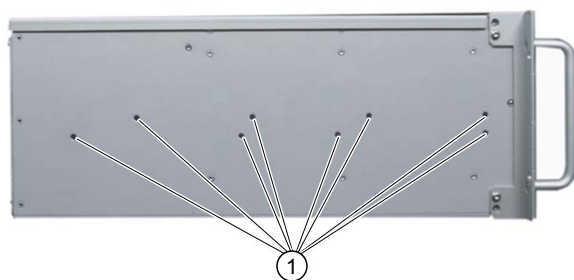

Position of the mounting holes (1) for angle brackets or telescopic rails

<b>CAUTION</b>
The mounting screws of the telescopic rails may not protrude more than 5 mm into the enclosure.

---

**Note**

For vertical operation, mount the device on a horizontal metal base and secure it against tipping. The following device bases are available from Rittal for this purpose: Rittal Type TE 7000.620, Rittal Type VR 3861.580, Rittal Type DK 7063.710.

Please refer to the case manufacturer's instructions regarding device bases.

---

 <b>CAUTION</b>
--

<b>Risk of injury!</b>
------------------------

It is not permitted to mount the device only on the 19" brackets of the front panel.
--

## Connecting

### 6.1 Connecting peripherals

#### Note before connecting

**NOTICE**

Connect only peripherals approved for industrial applications according to EN 61000-6-2.

**Note**

Hot-plug peripherals (USB) may be connected while the PC is in operation.

**CAUTION**

Peripherals that are incapable of hot-plugging may only be connected after the device has been disconnected from the power supply.

**CAUTION**

Strictly adhere to the specifications for peripheral equipment.

**NOTICE**

The connected or added peripherals must not introduce any counter emf into the device.  
A counter emf greater than 0.5 V to ground on the + 3.3V DC / + 5V DC / + 12V DC power rail due to a connected or integrated component can prevent normal operation or even destroy the computer.

When measuring the counter emf, remember the following:

- The computer must be turned off and the power supply connector should be plugged in.
- During the measurement, all cables from the plant to the computer should be connected.
- All other components in the plant must be active

## 6.2 Connecting the device to power

### Note before connecting

---

**Note**

The long-range power supply module is designed for operation on 100-240 AC networks. It is not necessary to adjust the voltage range.

---

** WARNING**

Do not connect or disconnect power and data cables during thunderstorms.

** WARNING**

The device may only be operated on grounded power supply networks (TN systems to VDE 0100, part 300, or IEC 60364-3).

Operation on ungrounded or impedance-grounded power networks (IT networks) is prohibited.

** WARNING**

The permitted nominal voltage of the device must conform with local mains voltage.

** CAUTION**

The mains connector must be disconnected to fully isolate the device from mains. Ensure easy access to this area.

A master mains disconnect switch must be installed if the device is mounted in a switch cabinet. Always ensure free and easy access to the power inlet on the device or that the safety power outlet of the building installation is freely accessible and located close to the device.

---

**Note**

The power supply contains a PFC (Power Factor Correction) circuit to conform to the EMC directive.

Uninterruptible AC power systems (UPS) must supply a sinusoidal output voltage in the normal and buffered mode when used with SIMATIC PCs with a PFC.

UPS characteristics are described and classified in the standards EN 50091-3 or IEC 62040-3. Devices with sinusoidal output voltage in the normal and buffered mode are identified with the classification "VFI-SS-...." or "VI-SS-....".

---

## Localized information

### Outside of the USA and Canada, operation on a 230 V power supply:

This device is equipped with a safety-tested power cord which may only be connected to a grounded shockproof power outlet. If you choose not to use this cable, you must use a flexible cable of the following type: Min. 18 AWG conductor cross-section and 15-A / 250-V shock-proof connector. The cable set must be compliant with safety regulations and stipulated IDs of the country where the system is to be installed.

### For the USA and Canada:

A CSA or UL-listed power cord must be used for the United States and Canada.

The connector must be compliant with NEMA 5-15.

### 120 V AC power supply

A flexible power cord approved to UL and with CSA label should be used. It should have the following features: Type SJT with three leads, min. 18 AWG conductor cross-section, max. length 4.5 m, parallel grounding plug 15 A, min. 125 V.

### 240 V AC power supply

A flexible power cord approved to UL and with CSA label should be used. It should have the following features: Type SJT with three conductors, min. 18 AWG conductor cross-section, max. length 4.5 m, and tandem grounded connector 15 A, min. 250 V.

## Connecting

Steps for connecting the device to mains	
1	Connect the IEC connector
2	<p>Connect the power cord to the mains outlet and switch on the mains isolation switch (if this exists).</p> <p>The yellow power LED (standby) on the front panel of the PC lights up.</p>



### Secure the power plug

You can secure the power plug in order to avoid unintentional disconnection of the power cord.

Steps for securing the power plug	
1	Remove the fastening screw (1) on the power supply module.
2	Screw the power plug interlock (2) onto the power supply module.

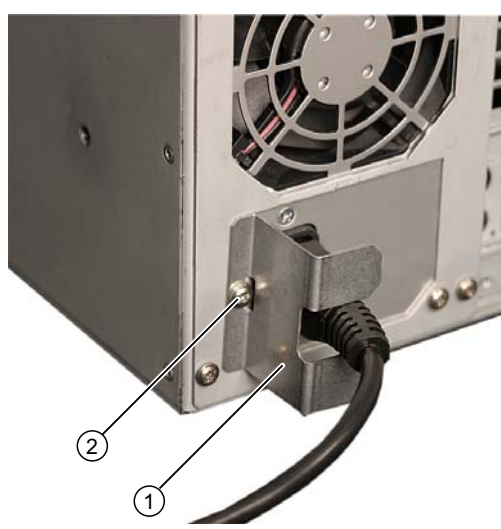

**⚠ WARNING**

If the power plug is secured with a clamp, the power outlet must be freely accessible to allow the device to be easily removed from the mains.



## 6.3 Equipotential bonding

A low-impedance ground connection improves the discharge of interference generated by external power cables, signal cables or cables for I/O modules to ground.

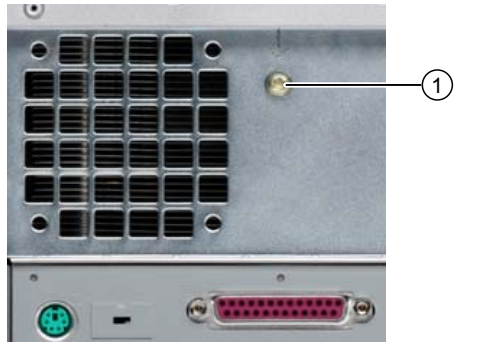
Equipotential bonding terminal	
<p>The equipotential bonding terminal (1) on the device (large surface, large-area contact) must be interconnected with the central grounding busbar of the cabinet or plant in which the PC is to be installed. The minimum conductor cross-section may not be less than 5 mm<sup>2</sup>.</p>	



## Commissioning

### 7.1 Requirements for commissioning

- Before you switch on the device, you should verify that all peripheral devices such the keyboard, mouse, monitor and the power supply are connected.
- The operating system of your device is preinstalled on the hard disk.

#### CAUTION

##### Risk of damage to the device!

Make sufficient allowances for the device to acquire room temperature before you put it into use. If condensation develops, wait at least 12 hours before switching on the device.

### 7.2 Initial Commissioning - Initial Startup

The Rack PC operating system is automatically set up the **first** time you switch on the device. Proceed as follows:

1. Press the on/off button. The green power LED lights up. The PC performs a POST. During the self-test, this message appears:  
Press <F2> to enter SETUP
2. Wait until this message is cleared, then follow the instructions on the screen.
3. Type in the Product Key as required. You find this key on the "Certificate of Authentication" in the "Product Key" line.

#### NOTICE

The PC may not be switched off at any time during the entire installation procedure.  
**Do not** change the default BIOS settings, otherwise the operating system setup may become corrupted.

4. Automatic restart

After you have entered all necessary information and after the operating system setup is completed, the PC is automatically restarted and displays the user interface of the relevant operating system.

From now on, after you switch on the PC, the user interface of the operating system is automatically opened when the startup routine is completed.

## Switching off the device

---

### Note

When working with Windows, always switch off the PC by clicking **Start > Shut Down**.

---

Press the on/off button behind the front panel door. The green power LED is switched off. Disconnect the mains connector to isolate the device from mains.

## 7.3 Windows XP, Vista Security Center

### Warning from the Windows Security Center

A warning from the Windows Security Center appears the first time you switch on your device. The Security Center checks the status of the device in regard to the three important security aspects listed below. If a problem is detected (an outdated antivirus program, for example), the Security Center issues a warning and makes recommendations on how you can better protect the device.

- **Firewall:** The Windows Firewall adds protection to the device by blocking network or Internet access to the device by unauthorized users. Windows checks if the device is protected by a software firewall.  
The firewall is enabled by default in the factory state.
- **Antivirus software:** Antivirus programs add protection to the device by searching for and eliminating viruses and other security threats. Windows checks if a full-range, up-to-date antivirus program is running on the device.  
No antivirus software is installed in the factory state.
- **Automatic updates:** Using the Automatic Update feature allows Windows to regularly search for the latest critical updates for the device and to install them automatically. This feature is disabled in the factory state.
- **Real-time protection (Vista only):** Windows Defender displays warnings if spyware or possibly unwanted software is installed or executed on the computer. You will also receive a warning if programs attempt to modify important Windows settings.

Configure the Security Center according to your requirements.

## 7.4 Notes on operation

### 7.4.1 DVD burner

The DVD burner drive is an optional feature. Recording methods supported by the disk drive: Disc-at-once, Track-at-once, Session-at-once, Packet writing. CD-R, CD-RW, DVD+R, DVD-R, DVD-RW and DVD+RW and dual layer media can be used.

#### Burner software

In order to utilize full functionality of the DVD burner you need to install additional software (burning software). This software is included on the CD supplied with the device. Insert the CD in the drive, run setup and follow the instructions on the screen.

#### NOTICE

When first starting the burner software, no disks should be inserted in the drive. This is because disks with errors can interrupt the automatic hard drive recognition. This makes it impossible to correctly display the possible burner functions.

#### Notes on burning optical disks

#### CAUTION

##### **Danger of data errors when burning disks!**

Burning is permissible only in an undisturbed environment, i.e. shock and vibration stress must be avoided. Because of heavy fluctuation in the quality of CD-Rs, data may be corrupted in a burning session, even if no error message is initially displayed. The written data can only be verified by comparing these with the source. To be on the safe side, data should be verified after every burning session.

### 7.4.2 Removable hard disks

The removable cartridges support hot-swapping in a RAID1 system.

#### Replacing a hard disk

 <b>CAUTION</b>
Hard drives may only be replaced in an removable cartridge if the device status display is off.

**Note**

The table and information below apply only to the delivery state of the device, that is no changes or expansions were made.

How to remove the hard disk drive:

1. Check which hard disk the RAID controller has reported being faulty (hard disk at channel 1 or 2).

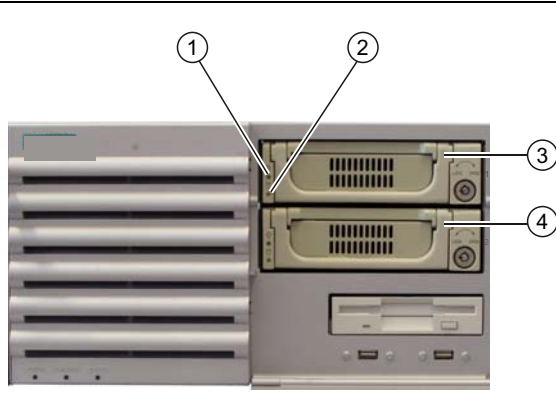
	(1)	Power LED voltage supply available
	(2)	HDD activity display

The table below shows the assignment of the removable cartridge positions in the device to the RAID system reports:

RAID BIOS	RAID software	SATA interface	Installation location	Enclosure labeling
Port 0	Device Port 0	SATA1	(3) Removable cartridge 1	1
Port 2	Device Port 2	SATA3	(4) Removable cartridge 2	2

Information about the recovery of the RAID system is available in the next section.

1. Set the key switch to the "OPEN" position.
2. Lift up the folding handle of the hard disk cartridge.
3. Pull the hard disk cartridge out.

Notes on operation

<b>NOTICE</b>
Always interlock the hard disk cartridge with the removable cartridge in order to ensure reliable operation of the device.

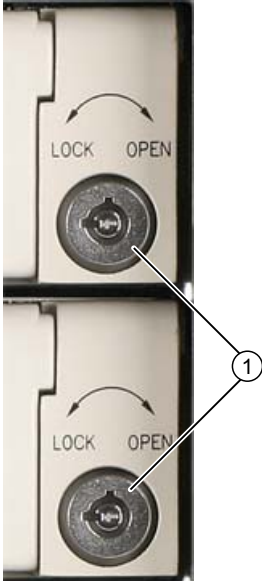
	(1)	Removable cartridge lock
--	-----	--------------------------

### 7.4.3 2HDD system (optional)

When the device ships, the second hard disk is connected to SATA port 3. This hard disk drive is not set up. This gives you the option of backing up your data to this hard disk. For information on hard disk capacities, refer to your order documentation.

#### Booting from the slave hard disk

In order to allow booting from the second hard disk, you need to configure it as the primary boot device. Make the following settings in your BIOS Setup:

Select Boot > Hard Drive > <Disk name> e.g. STxxxxxxx- SATA3, then press the "+" key to move it up in the boot order.

<b>NOTICE</b>
The drive letters for the partitions on both drives are assigned by the operating system used. You can change these in the Control Panel as required.



## 7.4.4 RAID system

This is a RAID1 system configuration (data mirroring with two hard disks). This configuration enhances system availability as the system is able to continue operation if a hard drive fails, or if there is a cable problem at a channel.

---

### Note

You can find information regarding Intel RAID controllers in the RAID documentation on the included "Documentation and Drivers" CD in the Drivers\RAID\Intel directory.

---

```
Intel(R) Matrix Storage Manager option ROM v5.6.2.1002 ICH7R wRAID5
Copyright(C) 2003-06 Intel Corporation. All Rights Reserved.

RAID Volumes:
ID Name Level Strip Size Status Bootable
0 Volume0 RAID1(Mirror) N/A 149.1GB Rebuild Yes

Physical Disks:
Port Drive Model Serial # Size Type/Status(Vol ID)
0 ST3160815AS 5RA01YJT 149.1GB Member Disk(0)
2 ST3160815AS 5RA01YHY 149.1GB Member Disk(0)

Press <CTRL-I> to enter Configuration Utility...
```

### RAID system management functions

The pre-installed RAID system software offers enhanced functionality for RAID system operation and management. Start the SW by selecting the "Start > Programs > Intel Matrix Storage Manager" command.

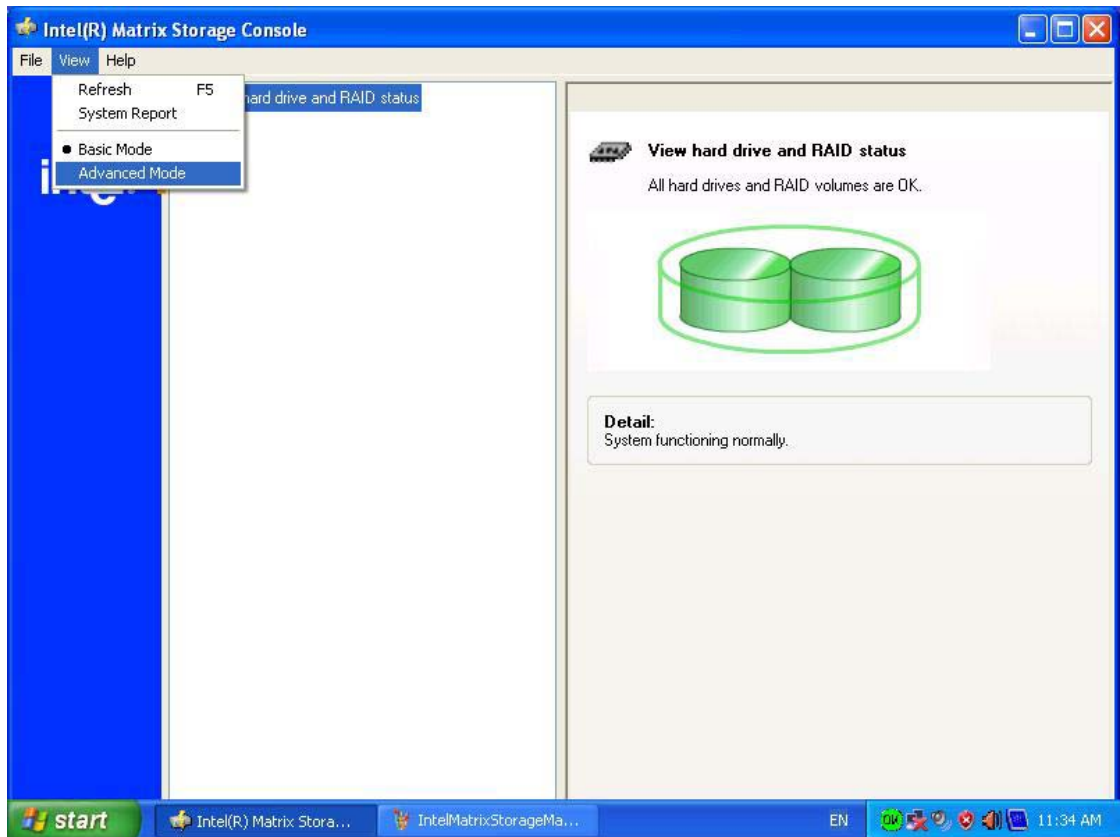

The "View -> Advanced Mode" command returns details of the RAID volumes.

The command "View -> System Report" can be used to create a report with details of the RAID volumes.

#### NOTICE

The RAID status entries are returned by default in the Windows event view and in the log file of the program.

A hard drive can be synchronized at operating system level if a fault is detected. It may take up to several hours to synchronize a new disk in the background, depending on the size of the hard disk and on the system load.

The redundant system state RAID 1 is reached again only after synchronization is completed.

## Comments about faults

### NOTICE

#### Input delay

Depending on the load on the processor and the hard disk activity at the time, the system may become briefly overloaded when a disk fails due to the synchronization process.

In extreme cases, input from the keyboard and touch screen may be delayed for a brief period.

## Replacing a faulty drive in a RAID array

Replace faulty RAID drives with a new drive in order to recover secure RAID1 state. The RAID software reports the faulty drive and returns details of the operable hard drive.

The functioning hard drive is indicated in BIOS by its port number, or by the RAID software by its device port number.

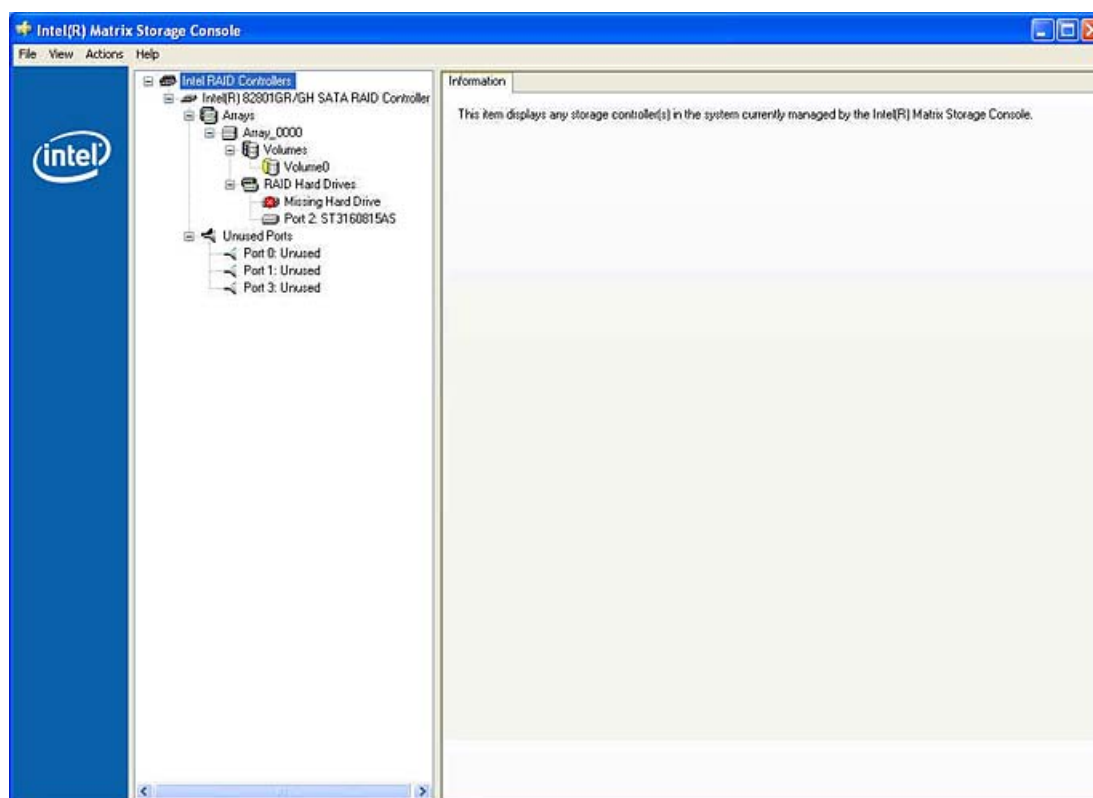

The functioning drive can be localized by means of the following table.

The table and information below apply only to the delivery state of the device, in other words, no changes or expansions have been made.

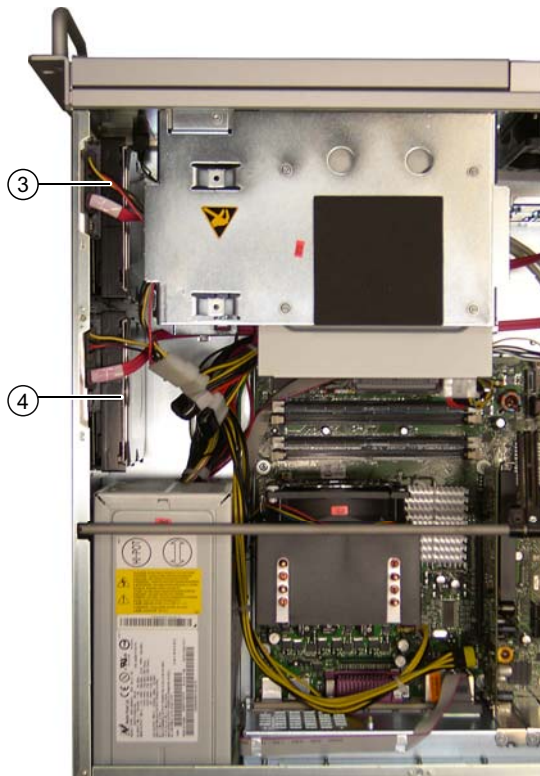
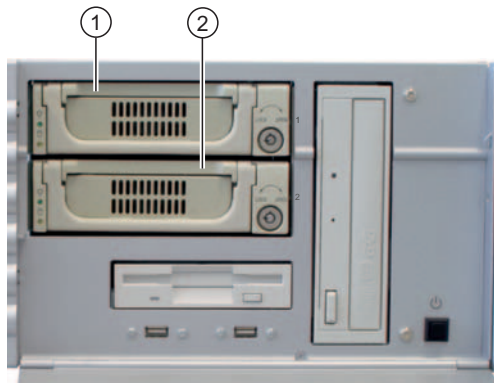

RAID BIOS	RAID software	SATA interface	Installation location	Enclosure labeling
Port 0	Device Port 0	SATA1	(1) Removable cartridge 1	1
Port 2	Device Port 2	SATA3	(2) Removable cartridge 2	2
Port 0	Device Port 0	SATA1	(3) Side panel 1	1
Port 2	Device Port 2	SATA3	(4) Side panel 2	2

Please replace the faulty drive with a new one of the same type and capacity.

## NOTICE

Drives in removable cartridges can be hot-swapped without shutting down the device. Devices without removable cartridges may only be replaced in shutdown state.

The new HDD can be integrated into the RAID system at operating system level by means of the RAID software. This is not possible as BIOS level.

### Points to note if the hard disk is replaced when the computer is turned off

Only a hard disk that was active and functioning correctly when you booted can later be included in the RAID array.

To be able to boot from the RAID system, you must place this first in the list of bootable sources in the BIOS "Boot" setup menu. Otherwise the system will boot from the hard disk you have just installed and the message "Operating System not found" will be displayed.

### Integrating a new hard drive

Select the "Rescan for Plug and Play Devices" command to find and indicate the new HDD.

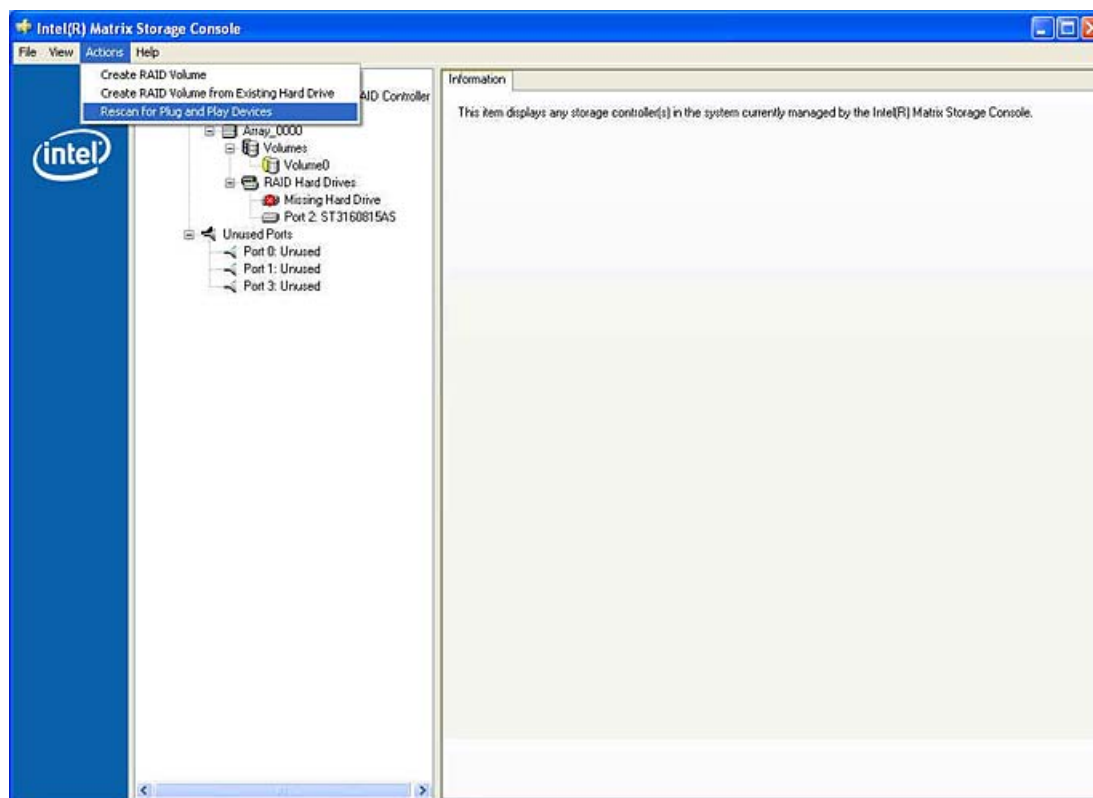

If you have shut down and restarted the system without installing a functioning new hard disk, "unused" will be displayed for the corresponding SATA port. In this case, you will need to shut down the system again and boot with the functioning hard disk. The new hard disk is then assigned to a SATA port and can be included in the RAID array. The "Rebuild to this Hard drive" command initiates synchronization of the RAID1 system.

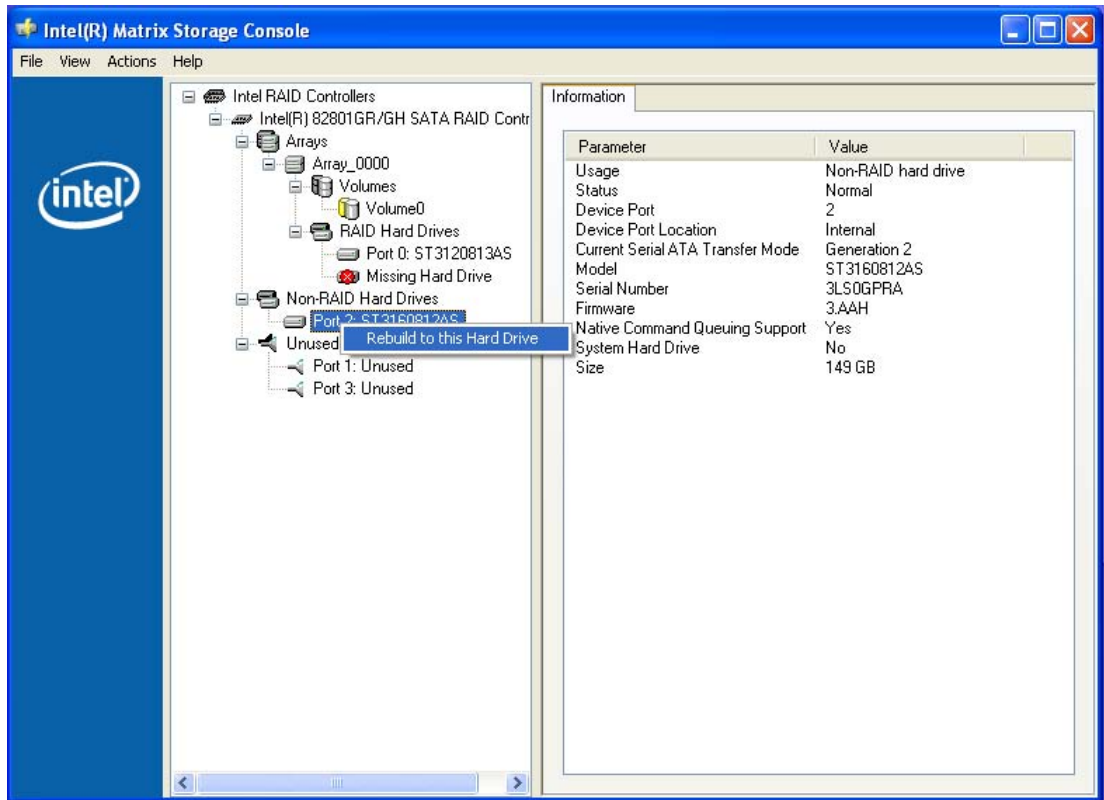

## Notes for RAID configuration with installed SIMATIC PC DiagMonitor software

When creating a RAID-system where SIMATIC PC DiagMonitor software is being used, the Intel Matrix Storage Console may abort the process with the following error message:

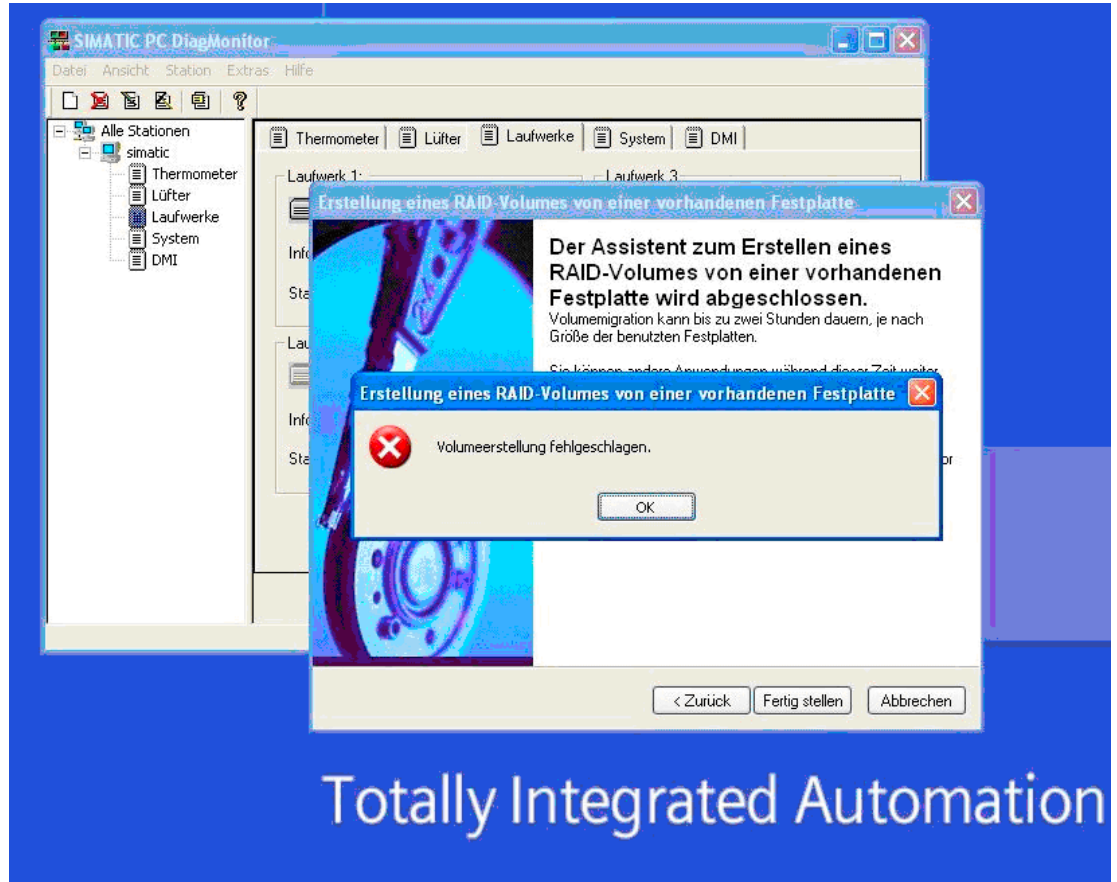

### Solution:

Before performing a RAID commissioning, the SIMATIC PC DiagMonitor should be deactivated. Subsequently, it can be reactivated.

### Measures:

#### If the DiagMonitor Management Station is in operation on your device:

- Close all applications, also the Management Station.
- Afterwards, stop the DiagMonitor SNMP Agent (SOL-Agent). In order to do so, select **Start > Run** and enter `cmd` in the field.
- Afterwards, enter `Net stop snmp` and confirm with the Enter key.

#### If your device is remotely monitored with SIMATIC PC DiagMonitor:

In this case you need **only** stop the DiagMonitor SNMP Agent (SOL-Agent).

- In order to do so, select **Start > Run** and enter `cmd` in the field.
- Afterwards, enter `Net stop snmp` and confirm with the Enter key.

<b>NOTICE</b>
If you do not keep to the procedure described above, a correct RAID configuration cannot be guaranteed.



# Integration

## 8.1 Integration

The following options are available for the integration of the device in existing or planned system environments/networks:

### Ethernet

The integrated Ethernet port (10/100/1000 Mbps) can be used for communication and for data exchange with automation devices such as SIMATIC S7.  
For this purpose you require the "SOFTNET S7" software package.

### Additional information

You can find additional information in the catalog and to the online ordering system of Siemens A&D.

Internet address: <https://mall.ad.siemens.com>



## Functions

### 9.1 Overview of the monitoring functions

The following individual functions are implemented:

- Temperature monitoring and over/under-temperature display
- Watchdog
- Fan monitoring
- Passing the status and messages to applications (only with DiagMonitor)

---

**Note**

The monitoring software is not preinstalled. SystemGuard can be installed from the supplied Documentation and Drivers CD. DiagMonitor can be ordered separately as an option and ships on CD.

---

<b>NOTICE</b>
---------------

The "SystemGuard" and "DiagMonitor" software cannot be installed simultaneously. Simultaneous installation and operation can result in errors because both programs access the same interfaces.
---

A description of the drivers and SystemGuard is available on the enclosed "Documentation and Drivers" CD in the utilities directory.

## 9.2 Temperature monitoring/display

### Temperature monitoring

Temperature errors do not occur under normal operation. If a temperature does occur, check for the following possible causes:

- Are the fan apertures covered?
- Is the filter dirty?
- Is the fan functioning correctly?
- Is the ambient temperature within the specified range?
- Is the total output of the power supply within the specified limit?

The problem is indicated by the status LED on the front panel and by the monitoring software if it is installed.

The temperature error is retained until the temperatures have fallen below the thresholds and are reset by one of the following measures:

- The error alarm is acknowledged by pressing the Info button on the SystemGuard user interface.
- Restart of the device

## 9.3 Watchdog (WD)

### Function

The watchdog monitors program execution and reports a program crash to the user by means of various reactions.

The watchdog can only be activated by monitoring software. The watchdog is idle when the PC is switched on or after a hardware reset (cold restart), in other words, no watchdog reaction is triggered. If the watchdog is activated and was not retriggered by the monitoring software within the selected time, the monitoring software is activated.

You can find additional information on the supplied "Documentation and Drivers" CD in the utilities/sysguard directory.

## 9.4 Fan monitoring

The operation of the front fan, processor fan and power unit are monitored. If a fan fails, the status LED on the front panel is activated and this is also indicated by the monitoring software if it is installed.

Additional information is available on the supplied "Documentation and Drivers" CD in Utilities > Sysguard

## 9.5 Monitoring software

The monitoring software is not installed.

- SystemGuard can be installed from the supplied Documentation and Drivers CD. This is located in the Utilities\Sysguard directory
- DiagMonitor can be ordered as an option.

The DiagMonitor software CD contains the monitoring software, the software for the stations to be monitored, and a library for creating user-specific applications.



## Expansions and configuration

### 10.1 Opening the device

**CAUTION**

Work on the open device may only be carried out by authorized and qualified personnel. The device must always be kept closed, otherwise device safety cannot be ensured.

 **CAUTION**

**The device contains electronic components which may be destroyed by electrostatic charge.**

You therefore need to take precautionary measures before you open the device. Refer to the (ESD) guidelines for handling electrostatic sensitive devices.

#### Tools

All mechanical installation tasks on the device can be carried out with Torx T10 screwdrivers.

#### Preparation

Disconnect the device from the mains.

#### Liability disclaimer

All specifications and approvals apply only to expansion units which are released by SIEMENS.

No liability can be accepted for impairment of functions caused by the use of third-party devices or components.

Observe the installation instructions for the components. UL approval of the device only applies when the UL-approved components are used according to their "Conditions of Acceptability".

### Opening the device

Steps for opening the enclosure cover	
1	Remove the mounting screws (1).
2	Lift up the lid from the back and remove it.



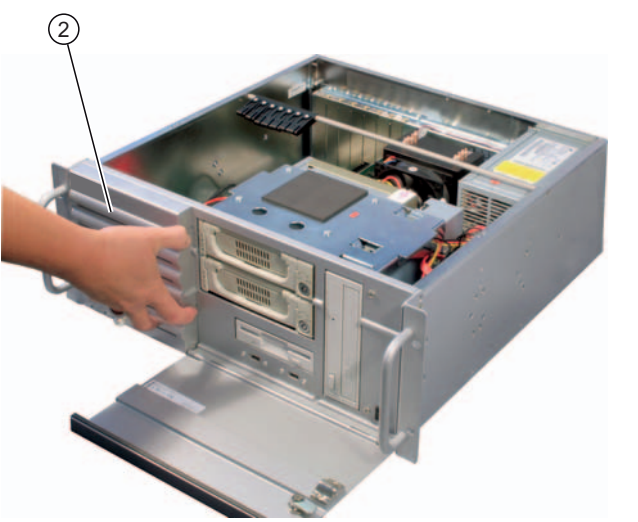

Steps for opening the device front	
1 Tilt the front door (1) forward.	
2 Remove the fan cover (2).	

## 10.2 Memory expansion

### Memory expansion options

The motherboard is equipped with four slots for memory modules. This allows you to expand Rack PC memory up to 4 GB, of which you can use approx. 3.2 GB for the operating system and applications.

You will find a detailed description of possible memory expansion options in the motherboard technical manual D2156-S21 on the supplied "Documentation and Drivers" CD.

## 10.3 Installing expansion cards

### 10.3.1 Notes on the modules

#### Notes on module specifications

The device is designed for use with modules to PCI specifications 2.3 or 1.0a. The dimensions of the cards may not exceed the specified dimensions. If the height is exceeded, you may experience contact problems, malfunctions and difficulties with the assembly. The permissible module dimensions are specified in the dimension drawings section.

<b>NOTICE</b>
The performance is limited for PCI modules with 5V supply voltage. The output of the modules may not exceed 25W in total.

#### Note about long PCI, PCIe modules

Before long modules can be inserted into the guide rails, they must be fitted with an extender (this should form part of the scope of supply of long modules).

#### Notes on the allocation of resources

Due to the number of functions on the motherboard, there are no reserved interrupts for PCI modules. If the new expansion module requires exclusive resources, you have to disable the functions on the motherboard. You will find notes on the allocated resources in the motherboard technical manual D2156-S21 on the supplied "Documentation and Drivers" CD and in the section Detailed descriptions > System resources.

## 10.3.2 Installing an expansion module

### Preparation

Disconnect the device from mains.

### Installing expansion modules

Steps for installing an expansion module:	
1	Opening the device
2	Hold the posts (3) of the module bracket at both ends and lift it out.
3	Remove the relevant steel slot cover (2).
4	Insert the expansion module (1) into the relevant slot.
5	Screw-tighten the steel slot cover (2) of the expansion module.
6	Insert the module bracket again.
7	Release the free module bracket (4), fit it on the expansion module and secure it with the screws. With short expansion modules, you can remove the locking screw from the bracket and screw it into the hole on the opposite side.
8	Close the device.

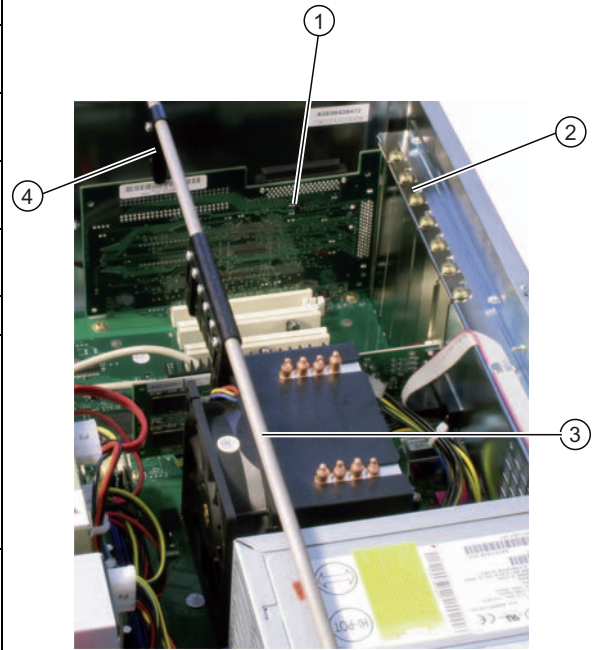

## 10.4 Installing drives

### 10.4.1 Options of installing disk drives

The driver bay module consists of a horizontal and vertical driver carrier. A DVD-ROM, DVD burner, floppy drive or removable cartridge can be installed in the drive bay module.

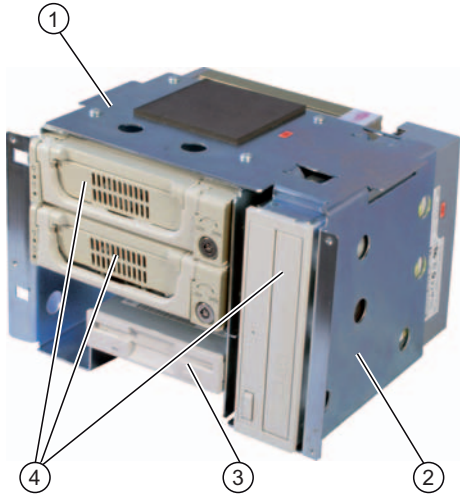
Drive bay module	Item	Description
	(1)	Horizontal drive bay
	(2)	Vertical drive bay
	(3)	3.5" floppy desk drive (FD)
	(4)	5.25" mounting bays for DVD/CD or hard drives in removable cartridges

## 10.4.2 Installing and removing a disk drive or removable rack

### Preparations

1. Unplug the device from mains and disconnect all cables.
2. Open the device.

### Removing the drive bay module

The drive bay module consists of a horizontal and vertical drive bay.

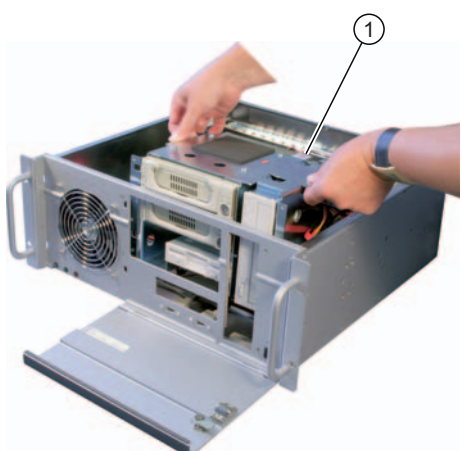
Steps for removing the drive bay module		
1	Loosen the mounting screws of the drive bay module.	
2	Disconnect the power cable and the data cable from the installed disk drives.	
3	Lift the drive bay module (1) out of the device until you can access the cables of the floppy disk drive. Disconnect these cables.	
4	Remove the drive bay completely from the device.	

### Installing drives or removable cartridges

Steps for installing a disk drive in a horizontal drive bay	
1	Slide the disk drive into the carrier from the front.
2	Remove any vertical drive bay The only way to get at the mounting screws on the right side of the drive is through the openings of the vertical carrier.
3	Mount the disk drive into the drive bay using four screws.
4	Insert the drive bay module again.
5	Connect the power and data cables to the disk drive.

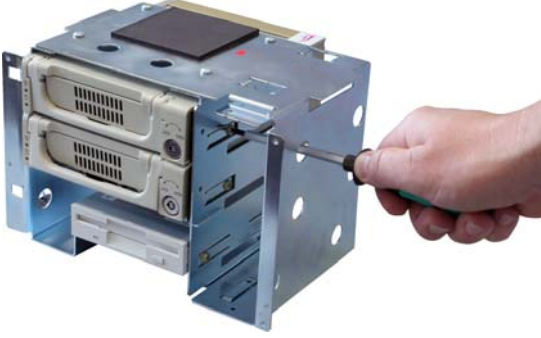
A photograph showing a person's hand using a screwdriver to secure a disk drive into a metal carrier. The carrier is a blue metal frame with several drive bays. The disk drive is a silver and black unit. The hand is positioned on the right side of the carrier, using the screwdriver to tighten a screw into one of the four mounting holes on the right side of the drive bay.

### 10.4.3 Installing and removing a hard disk

#### Preparations

1. Unplug the device from mains and disconnect all cables.
2. Open the device

#### Installing a drive

How to install a drive	
1	Connect the power and data cables to the disk drive.
2	Hold the drive on the drive bay plate and secure it with 4 screws (1) or (2).

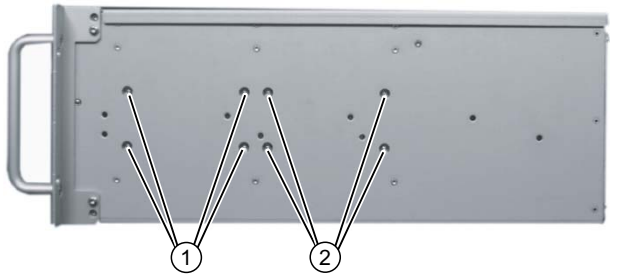

The diagram shows a rectangular drive bay plate with a handle on the left side. Four screws are shown being inserted into the plate. Two screws are labeled with a circled '1' and two are labeled with a circled '2'.

#### Removing drives

How to remove a drive	
1	Disconnect the power and data cables from the drive.
2	Remove the four screws (1) or (2) and take the drive out of the housing.





## Maintenance and service

### 11.1 Removing and installing hardware components

#### 11.1.1 Repairs

##### Performing repairs

Only authorized personnel are permitted to repair the device.

 <b>WARNING</b>
---

Unauthorized opening and improper repairs on the device may result in substantial damage to equipment or endanger the user.
---

- Always disconnect the power connector before you open the device.
- Install only system expansions which are designed for this computer. If you install other expansion devices, you may damage the system or violate the safety requirements and regulations on RF suppression. Contact Technical Support or your local sales department to find out which system expansions are suitable for installation.

**If you install or exchange system expansions and damage your device, the warranty becomes void.**

<b>NOTICE</b>
---------------

Read the information about ESB.
---------------------------------

##### Liability disclaimer

All specifications and approvals apply only to expansion units which are released by SIEMENS.

No liability can be accepted for impairment of functions caused by the use of third-party devices or components.

##### Tools

All mechanical installation tasks on the device can be carried out with Torx T10 and Torx T20 screwdrivers as well as a side-cutter.

### 11.1.2 Replacing filters

**Note**

Filter meshes are available under the following order numbers: A5E00246975

How to replace the filter	
1.	Tilt the front door (1) downwards.
2.	Remove filter cover (2) and remove filter.

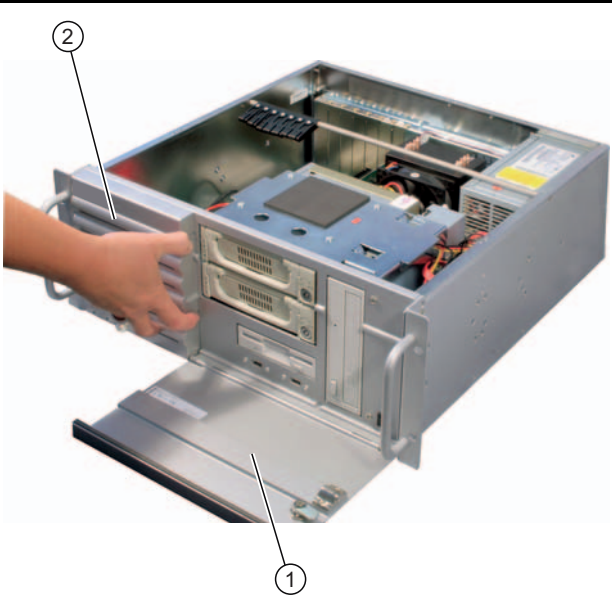

The diagram illustrates the first step of the filter replacement process. A hand is shown tilting the front door of the SIMATIC Rack PC 547B downwards. The door is labeled with a circled '1'. A filter cover is visible on the front panel, labeled with a circled '2'. The internal components of the rack, including a power supply and various modules, are visible through the open door.

### 11.1.3 Removing the device fan

#### Preparing for equipment fan exchange

Unplug the device from mains.

#### Remove the fan

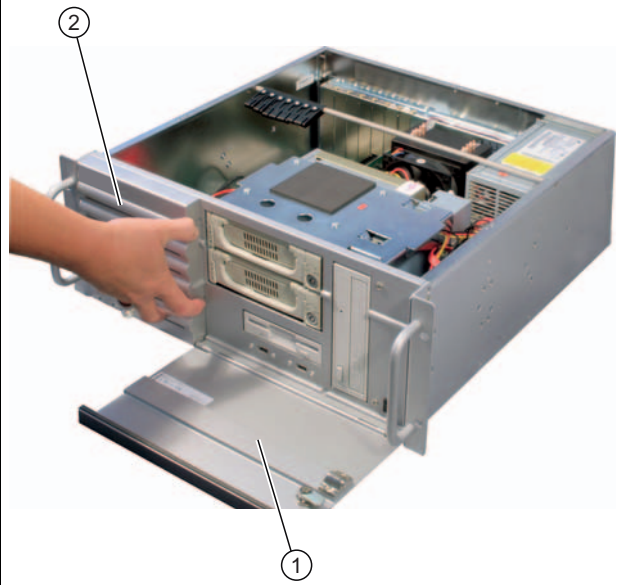
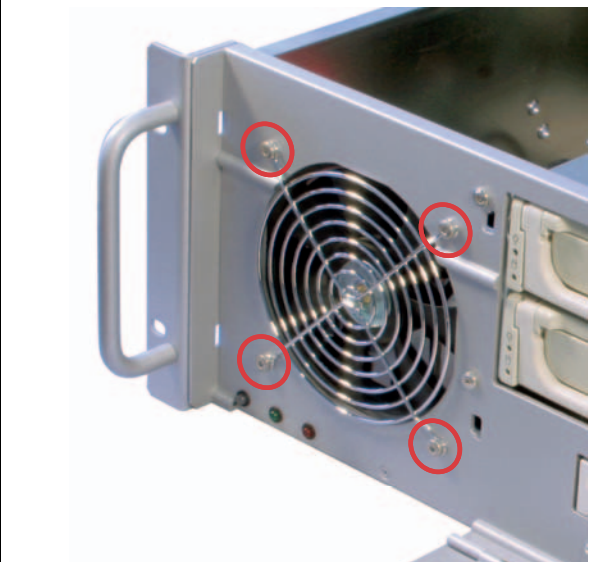
Steps	
1. Tilt the front door (1) downwards.	
2. Lift off the fan cover (2).	
3. Open the device cover.	
4. Unplug the fan connector from the motherboard.	
5. Remove all fan screws.	

## Installing the fan

<b>NOTICE</b>
---------------

Always install a fan of the same type!
--

<b>CAUTION</b>
----------------

Ensure that the arrow on the fan points away from the fan bracket.
--

### 11.1.4 Replacing the backup battery

#### Note before you replace the battery

---

**Note**

Batteries are wearing parts. Backup batteries should be replaced at intervals of 5 years in order to maintain PC functionality.

---

**CAUTION**

Risk of damage!

The lithium battery may only be replaced with an identical battery or with a type recommended by the manufacturer. Information about original spare parts for SIMATIC PCs is available at <http://www.siemens.com/asis>

#### Disposal

**CAUTION**

Depleted batteries must be disposed of in accordance with local regulations.

#### Preparation

---

**Note**

The configuration data of the device are deleted when the battery is replaced. Note the current BIOS Setup settings. You can conveniently back up the BIOS settings by means of the SIMATIC PC BIOS manager.

---

#### Replacing the battery

The location of the backup battery on the motherboard and the procedure for replacing it is described in technical manual, D2156-S21, on the supplied "Documentation and Drivers" CD.

#### Reconfiguring the BIOS setup

When a battery is exchanged, the configuration data of the device are lost and must be reentered in the BIOS setup.

### 11.1.5 Removing the power supply module

 <b>WARNING</b>
Only qualified personnel are allowed to replace the power supply unit.

#### Preparations

1. Unplug the device from mains and disconnect all cables.
2. Open the device.

#### Removing the power supply unit

How to remove the power supply module	
1.	Disconnect the power cables from the disk drives and motherboard.
2.	Remove the tie-wraps holding the power cables in the housing.
3.	Remove the mounting screws (TORX T10) (1).
4.	Lift the power supply module out of the enclosure until you can access the power cable of the floppy disk drive.
5.	Disconnect this power cable from the floppy disk drive.
6.	Remove the screws (2) on the steel bracket.



## 11.1.6 Removing the motherboard

### Preparation

1. Unplug the device from mains and disconnect all cables.
2. Open the device.

### Removing the motherboard

How to remove the motherboard	
1.	Remove all modules from their slots.
2.	Disconnect all cables from the motherboard, noting down their positions while doing so.
3.	Remove ten screws from the motherboard.



A replacement motherboard is supplied without processor and memory modules.

### 11.1.7 Processor replacement

<b>CAUTION</b>
The processor replacement may only be carried out by authorized qualified personnel. If the processor type is changed, the BIOS must be updated so that the suitable microcode is loaded.

#### Preparation

1. Unplug the device from mains.
2. Open the device.

#### Removing the processor

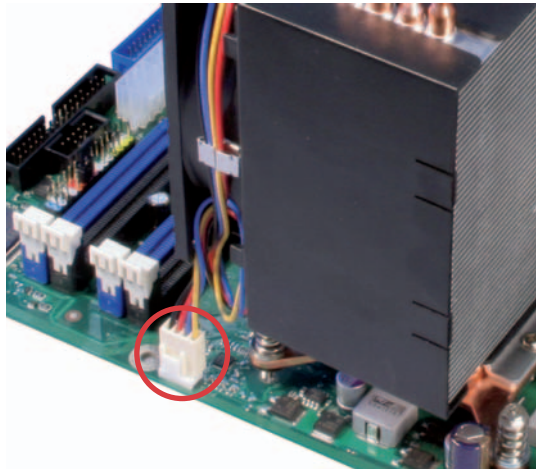
How to remove the processor		
1.	Unhook the fan holder on the heat sink and pull off towards the front.	
2.	Disconnect the processor fan connector.	
3.	Loosen the four screws and remove the heat sink.	



How to remove the processor	
<p>4. Unlock the CPU socket and lift off socket cover.</p>	
<p>5. Remove processor.</p>	

Additional instructions can be found in the supplied Documentation & Drivers CD in the D2156-S21 manual.

 **CAUTION**

Operating a processor at a frequency higher than it specified speed can result in damage to the device and the loss of data.

Only certified and approved processors can be used with the supplied motherboard. For more information contact your local Siemens representative.  
<http://www.siemens.com/automation/partner>

## 11.2 Reinstalling the software

### 11.2.1 General installation procedure

If your software is corrupt, you can reinstall your software using the recovery CD or DVD, the Documentation and Drivers CD or the Restore DVD.

#### Recovery CD or DVD:

The recovery CD/DVD contains the Windows user interface with tools for configuring the hard drives, and for installation of the operating system and the languages supported by the operating system (MUI).

The basic language of the operating system that is installed is English. If you want to include additional languages, you can install these later from the recovery CD2 or DVD.

#### Documentation and Drivers CD:

Contains the documentation and the hardware drivers.

#### Restore DVD:

Contains a hard disk image file with the original factory software (operating system with installed hardware drivers).

## 11.2.2 Restoring the Factory State of the Software Using the Restore DVD

You can restore the software to the original factory state using the Restore CD (not included in all package variants). The DVD contains the necessary images and tools for transferring the factory software to the hard disk of your PC. You can only restore the entire hard disk with drive C: (system) and drive D: or only drive C: . This allows you to retain any user data on drive D:.

### Retrieving authorizations or license keys from the hard disk

- Check whether you can retrieve your authorization or license key from the hard disk and perform this procedure as described below if possible.
- Contact Customer Support if you are unable generate a backup copy. There you can obtain information necessary for software authorization.

#### CAUTION

If "Restore system partition only" is set all data on drive C: (system partition) will be deleted. All data, user settings and all authorizations or license keys on drive C: are lost! All data on drive C: of the hard disk will be deleted. Setup formats the hard disk and installs the original factory software.

If "Restore entire hard disk" is set ALL data, user settings, authorizations or license keys will be lost on the hard disk.

### Restoring the factory state

To restore the delivery state:

- Place the Restore DVD into the drive and restart the device using the on/off switch.
- During the self-test phase, press the F12 key. The "Boot Menu" is displayed when initialization is completed.
- Select the optical drive using the cursor keys.
- Now follow the instructions on the screen.

#### CAUTION

All existing **data, programs, user settings** and **authorizations or license keys** will be deleted from the hard disk and therefore lost.

For information on the functions, refer to the README.TXT file on the Restore DVD.

### 11.2.3 Installing Windows

Use the recovery CD to create a Windows installation that meets your specific requirements. You also need the included Documentation and Drivers CD. Additional controllers unknown to the operating system must be made known to the recovery system and to the Windows operating system.

1. Press the F6 key while booting or the "Load Driver" icon and follow the on-screen instructions. During the rest of the installation, you will be asked several times for the missing driver of the controller.

#### Booting from recovery CD or DVD

1. To boot from the recovery CD or DVD, press the F12 key during the self-test phase. The boot menu displayed after initialization indicates all boot devices.
2. Select the CD/DVD drive.  
Follow the instructions on the screen until the "Siemens SIMATIC Recovery" window is displayed.

When using the recovery function with Vista, confirm that you want to boot from CD or DVD as soon as you restart. Otherwise the system boots from hard disk if you have a bootable hard disk installed.

The following sections describe older Windows operating systems. Recovery for Vista is described as of section 11.2.6.

### 11.2.3.1 Setting up partitions for Windows 2000, XP, Server 2003 operating systems

After you have installed a new hard disk, or if partitions are faulty, or when you wish to change the partitioning on your hard disk, you need to create or reconfigure partitions on the hard disk.

<b>CAUTION</b>
When you delete or create partitions or logical DOS partitions, you lose all data on the hard disk. All partitions on the hard disk will be deleted.

Microsoft recommends setup of the NTFS file system on hard disk partitions in Windows operating systems. To do this, proceed as follows:

#### Setting up partitions

When shipped, the partitions are set up as follows:

Partition	Operating system	Name	Size	File system
First	Windows 2000, XP	PROG	25 GB	NTFS not compressed
First	Server 2003	PROG	15 GB	NTFS not compressed
Second	Windows 2000, XP, Server 2003	DATA	Remainder	NTFS not compressed

1. Boot from the Recovery CD and then follow the on-screen instructions until the Recovery functions window is displayed.
2. Start the DiskPart tool in the "Siemens SIMATIC Recovery" window. Enter the following commands in the displayed command interface:

List disk	Displays all available hard disks.
Select disk 0	Selects the disk where you wish to change the configuration. 0 selects the first hard disk.
List partition	Displays all partitions on the selected hard disk.
Clean	Completely wipes the selected hard disk. All information stored there is lost.
Create partition primary size=n	Creates a primary partition with the n MB on the selected hard disk. Default values: n = 15000 for Windows Server 2003, n = 25000 for Windows 2000, XP
Select partition 1	Selects the primary partition.
Active	Activates the selected partition.
Exit	Closes DiskPart.

Additional DiskPart functions:

Help	Shows all available DiskPart commands. When a command is supplemented with other parameters, the command is described with additional information. Example: create partition help
------	--

---

**Note**

Once you have change the configuration of your hard disk with DiskPart, you will need to reboot the PC for the changes to go into effect.

Boot once again from the Recovery CD to format the partitions.

---

**Format primary partition**

1. Boot from the Recovery CD to format the partitions. Follow the screen instructions until the Recovery functions window is displayed.
2. Select "Start command prompt" in the Recovery functions window. Enter the following command in the displayed command prompt:

```
format drive:/FS:file system
```

drive = drive letter of the partition to be formatted. Valid values: C, D, E, F etc.

File system = Specifies the type of file system. Valid values: FAT, FAT32, NTFS.

NTFS is the factory setting for all Windows operating systems.

Example for the primary hard disk in the system:

```
format C:/FS:NTFS
```

format /? Shows all parameters of the command.

### 11.2.3.2 Installing Microsoft Windows operating systems

This CD contains encrypted data that can only be transferred to this system.

1. Boot from the Recovery CD and then follow the on-screen instructions until the Recovery functions window is displayed.
2. Select "Recovery Windows ..." in the "Siemens SIMATIC Recovery" window.
3. Follow the instructions on the screen.

---

#### Note

Make sure that sufficient free space is left on the drive after the transfer of selected recovery data:

500 MB for Windows 2000

1500 MB for Windows XP

1500 MB for Windows Server 2003

---

4. Select "Start command prompt" in the Recovery functions window.
5. Enter the following command in the displayed command prompt interface:  
Drive:  
cd \I386  
Winnt32.bat  
Drive: Drive letter of the folder containing the I386 directory.
6. The preparation of the Windows installation is displayed.
7. When this is completed, close the command prompt with the `exit` command.
8. Close the Siemens SIMATIC Recovery window with the "Finish" button.
9. The Windows installation is completed following an automatic restart of the system.
10. Follow the instructions on the screen.

---

#### Note

References required by professional users of Microsoft Windows (not included in the scope of delivery):

Microsoft Windows 2000 Professional Resource Kit (MSPress No 274) or

Microsoft Windows XP Professional, Technical Reference (MSPress No 934)

Microsoft Windows Server 2300, Planning Server Deployment for Windows Server 2003, Technical Reference (MSPress No. 420)

These manuals contain specific information for administrators who install, manage and integrate Windows in networks or multi-user environments.

---

### Information for systems with RAID controllers (optional)

Unknown additional controllers must be made known to the Windows operating system.

1. Press F6 key within the startup sequence and follow the on-screen instructions. In the next installation phases you are prompted several times to insert a floppy disk which contains the missing RAID driver. The driver is available on the included "Documentation and Drivers" CD in the Drivers\RAID\Intel directory.
2. Copy the corresponding driver to a blank, formatted floppy disk.
3. After the message to press the F6 key, select the driver "Type Intel(R) 82801GR/GH SATA RAID" on the screen in a selection window. To display the proposed list completely, you may need to scroll down with the arrow keys.

## 11.2.4 Setting up the language selection for Windows 2000 MUI

### Setting up the language selection for Windows 2000 MUI

The Multilanguage User Interface (MUI) of Windows 2000 allows you to change the menu and dialog language.

The dialog language for Windows 2000 menus and for the keyboard layout are set in the corresponding Control Panel dialog

**Start > Settings > Control Panel > Regional Options > General tab, Setting for the current user field and Language settings for the system field and the Keyboard layout field in the Input Locales tab.**

In addition to the menu and dialog language settings, also set the default language by selecting **Set Default...** in the **Regional Options** dialog box.

The default language setting of your Windows 2000 installation is English with US keyboard layout. To change to another language and keyboard layout, open the Control Panel and select

**Start > Settings > Control Panel > Regional Options>General tab, Menus and dialogs field and Language settings for the system field and the Input language field in the Input Locales tab.**

If you want to install additional languages, start the MUISETUP.EXE program from the recovery CD2



## 11.2.5 Language selection on Windows XP Professional and Windows Server 2003

The **Multilanguage User Interface (MUI)** in Windows XP allows you to change the menu and dialog language.

The default language setting of your Windows installation is English with US keyboard layout. You can change the language in the Control Panel

**Start > Control Panel > Date & Time, Language, and Regional Options > Add other languages, Languages tab, Language used in menus and dialogs field.**

For the **Date, Time, Language, and Regional Options**, set the default as **non-Unicode programs** under **Advanced** in addition to the language for menus and dialogs

If you want to install additional languages, start the MUISETUP.EXE program from the recovery CD 2.

### 11.2.6 Recovery of Windows Vista

To recover Windows Vista, there is a full graphical user interface available. It may take several minutes before the first input window appears. In this window, you can set the time and currency formats and select the keyboard language.

English is the basic language and other languages can be installed later with the MUI. The MUI is on the recovery DVD.

Now follow the on-screen instructions. It may take several minutes before the next prompt for the product key is displayed.

---

#### Note

Due to the previous activation, you do not need to enter the product key (COA number). This is entered automatically during the installation.

---

### Setting up and formatting partitions

After you have installed a new hard disk, or if partitions are faulty, or when you wish to change the partitioning on your hard disk, you need to create or reconfigure partitions on the hard disk.

In the next dialog box, you can set up the hard disk according to your requirements and add controllers that are not yet known to the system.

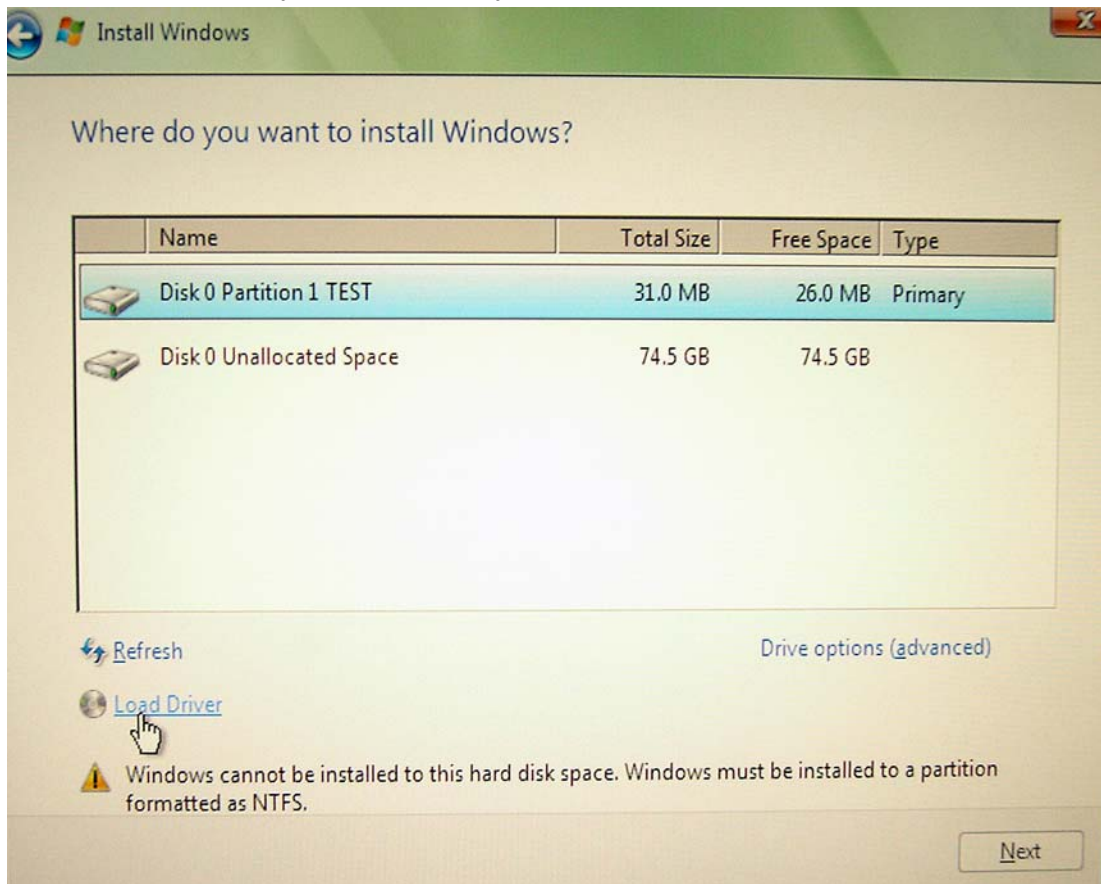

Options	Meaning
Drive options (advanced)	Further functions are displayed with which you can set up the hard disk.
Load Driver	To add new drivers, for example the driver for RAID.

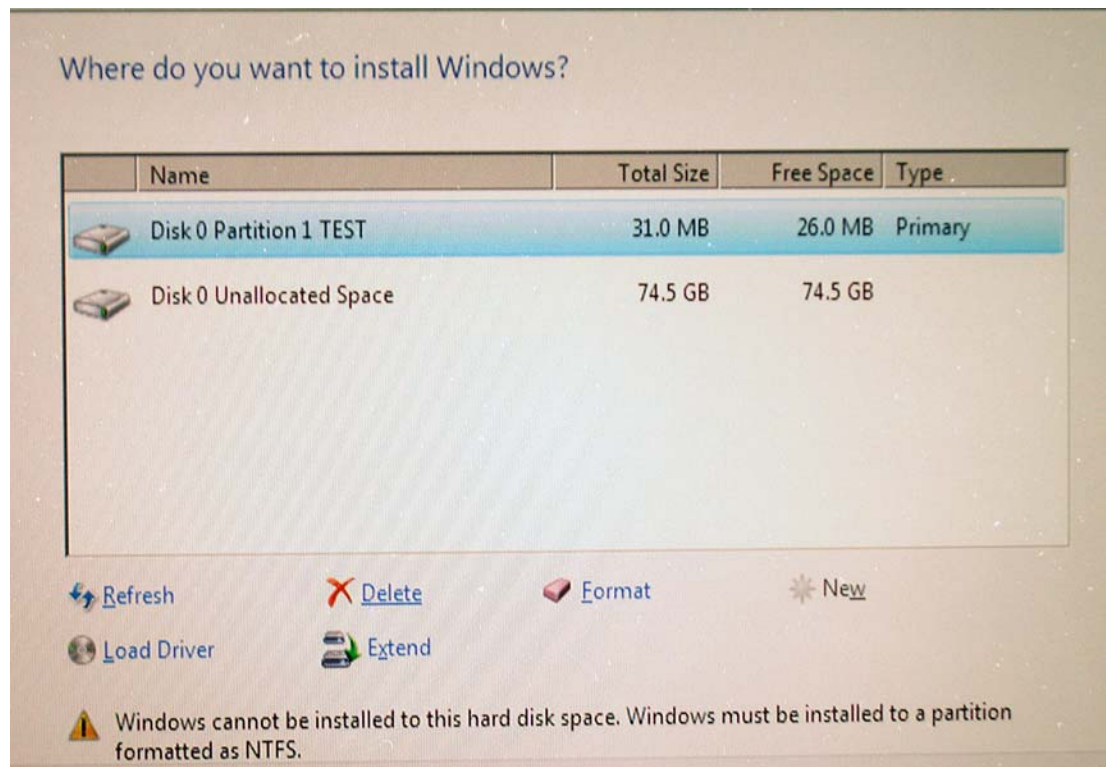

Options	Meaning
Refresh	Updating
Delete	Deleting a partition
Format	Formatting a partition
New	Creating new partitions
Load Driver	To add new drivers, for example the driver for RAID
Extend	Changing the partition size
	Any error messages that occur are displayed behind this icon, for example if the hard disk was not formatted in the required "NTFS" format.

The first partition should be at least 25 GB. The operating system must be installed on this partition. You can use the rest of the hard disk as a data partition. Both partitions must be installed as the NTFS file system.

When shipped, the partitions are set up as follows:

Partition	Operating system	Name	Size	File system
First	Windows Vista	System	25 GB	NTFS not compressed
Second	Windows Vista	DATA	Remainder	NTFS not compressed

Following a reboot, Windows Vista is installed on the hard disk. This process takes at least 20 minutes.

Now follow the instructions on the screen.

---

**Note**

If you want to reinstall drivers from the integrated floppy disk drive, select Floppy Drive (A:). If you want to reinstall drivers from a USB floppy disk drive, select Floppy Drive (B:).

---

---

**Note**

If you want to use Microsoft Windows as a professional user, you should have the following manual available (not supplied):  
Windows Vista Resource Kit

This manual contains specific information for administrators who install, manage and integrate Windows in networks or multi-user environments.

---

## Setting up language options in Windows Vista

With the Multilanguage User Interface (MUI), you can set up the Windows menus and dialogs for additional languages. When shipped, Windows Vista is installed with English menus and dialogs. You can change this in the Control Panel with the "Regional and Language options" or "Time and Date" dialogs.

Here, you can change all system formats:

Start > Control Panel > Clock, Language, and Region > Change display language > Regional and Language options

Here, you can only change the date and time formats:

Start > Control Panel > Clock, Language, and Region > Change display language > Time and Date

If you want to install additional languages, you can install these later in the Control Panel, as follows. You will find the necessary files on the recovery DVD in the "Languagepacks" folder.

Start > Control Panel > Clock, Language, and Region > Change display language > Regional and Language options > Keyboards and Languages

## 11.2.7 Installing drivers and software

### NOTICE

Before you install new drivers or updates for multilingual operating systems, (MUI versions), reset the regional settings for menus and dialogs and the default language to US English.

Install the drivers and software from the included "Documentation and Drivers" CD.

Procedure:

1. Place the CD into the drive.
2. Run *START*.
3. Select *Drivers & Updates* from the index.
4. Select the operating system in *Drivers & Updates*.
5. Install the required driver.

### NOTICE

If you require the driver for the chipset after reinstalling Windows 2000 / XP / Server 2003 / Vista, this must always be installed first before all other drivers.

## 11.2.8 Installing the RAID Controller software

The procedure for installing the software can be found in the user manual on the supplied "Documentation and Drivers" CD in the directory Drivers\RAID\Intel.

### Note on Windows 2000 Professional / XP Professional / Windows Server 2003 / Vista

Select the Intel(R) 82801GR/GH SATA RAID Controller from the proposed list when you install a Windows operating system. To display the list completely, you may need to scroll down with the arrow keys.

## 11.2.9 Installing burner/DVD software

Information about installation of the burner / DVD software is available on the supplied CD.

## 11.2.10 Installing updates

### 11.2.10.1 Updating the operating system

#### Windows

The latest updates for Windows operating systems are available on the Internet at <http://www.microsoft.com>

<b>NOTICE</b>
---------------

Before you install new drivers or operating system updates for Windows MUI versions, set the default language to US English in the regional settings for menus and dialogs.
---

#### Other operating systems

Contact the corresponding manufacturer.

### 11.2.10.2 Installing or updating application programs and drivers

Install and connect an appropriate drive in order to install software from a CD and / or floppy disk in Windows.

The USB floppy disk and CD-ROM drivers are included in Windows and do not have to be installed from other sources.

For information about installation of SIMATIC software packages, refer to the corresponding manufacturer documentation.

Contact the manufacturer to obtain updates of drivers and application programs you purchased from third-party vendors.

<b>NOTICE</b>
---------------

Before you install new drivers or operating system updates for Windows versions, set the default language to US English in the regional settings for menus and dialogs.
---

## 11.2.11 Data backup

### 11.2.11.1 Creating an image

#### Data backup in Windows

Siemens recommends using **SIMATIC PC Image Creator** to generate backup copies of your data. This tool provides comfortable and efficient functions for backup and restoring the full content of Compact Flash cards, of HDDs and of individual partitions (images.)

The software can be ordered from the Siemens A&D online ordering system. For detailed information about SIMATIC PC Image Creator, please refer to the corresponding product documentation.





## Troubleshooting/FAQs

### 12.1 General problems

This chapter provides you with tips on how to locate and troubleshoot common problems.

Problem	Possible cause	Remedy
The device is not operational	No power supply	Check the power supply, and the power cord / connector
	Device is being operated outside the specified ambient. conditions	<ul style="list-style-type: none"> <li>Check the ambient conditions.</li> <li>After transport in cold weather, wait approximately 12 hours before switching on the device.</li> </ul>
The external monitor remains dark.	The monitor is switched off.	Switch on the monitor.
	The monitor is in "power save" mode.	Press any key on the keyboard.
	The brightness button has been set to dark.	Increase brightness by means of luminance control. For detailed information, refer to the monitor operating instructions.
	The power cord or the monitor cable is not connected.	<ul style="list-style-type: none"> <li>Check whether the power cord has been properly connected to the monitor and to the system unit or to the grounded shockproof outlet.</li> <li>Check whether the monitor cable has been properly connected to the system unit and to the monitor.</li> </ul>
		If the monitor screen still remains dark after you have performed these checks, please contact your technical support team.
The mouse pointer does not appear on the screen.	The mouse driver is not loaded.	Check whether the mouse driver is properly installed and present when you start the application program. For more detailed information, refer to the manuals for the mouse or application programs.
	Mouse not connected.	Check whether the mouse cord is properly connected to the system unit. If you use an adapter or extension on the mouse cable, also check the connectors.
		If the mouse pointer still does not appear on the screen after you have performed these checks and measures, please contact your technical support team.
Wrong time and/or date on the PC.		<ol style="list-style-type: none"> <li>Press &lt;F2&gt; within the boot sequence to open the BIOS Setup.</li> <li>Set the time and date in the setup menu.</li> </ol>
Although the BIOS setting is OK, the time and data are still wrong.	The backup battery is dead.	In this case, please contact your technical support team.

12.1 General problems

Problem	Possible cause	Remedy
USB device not responding.	The USB ports are disabled in your BIOS.	Use a different USB port or enable the port.
	USB 2.0 device connected but USB 2.0 is disabled.	Enable USB 2.0.
	Operating system does not support the USB interfaces.	Enable USB Legacy Support for the mouse and keyboard. For other devices you need the USB drivers for your operating system.
DVD/CD: The front loader does not open.	The device is switched off or the open/close button is disabled by a software application.	Emergency removal of the data medium: <ol style="list-style-type: none"> <li>1. Switching off the device</li> <li>2. Insert a pointed object, a pin for example, or an opened paper clip into the emergency extraction opening of the drive. Apply slight pressure to the contact until the front loader opens.</li> <li>3. Pull the loader further out.</li> </ol>
The RAID software reports the following errors: <ul style="list-style-type: none"> <li>• The RAID plug-in failed to load, because the drive is not installed.</li> <li>• The Serial ATA plug-in failed to load, because the driver is not installed correctly.</li> <li>• The Intel® Matrix Storage Console was unable to load a page for the following reason: <ul style="list-style-type: none"> <li>– A plug-in did not provide a page for the selected device</li> <li>– A plug-in failed to load</li> </ul> </li> </ul>	RAID is not activated  RAID is activated	The messages have no negative effect on the operation of the device and can be ignored. Acknowledge the messages.  Install the software from the supplied Documentation and Drivers CD
After changing the hard disk, the system does not boot from the RAID array	RAID array does not have highest boot priority	Set the RAID array to be first in the boot order
After changing the hard disk, "unused" is indicated for the relevant SATA port	The system was booted without a functioning hard disk (the removable cartridge was possibly not turned on)	Reboot the system with a functioning hard disk
Computer does not boot or "Boot device not found" is displayed	The boot device is not first in the boot priority in the BIOS setup or is not permitted as boot device	Change the boot priority of the boot device in the Boot menu of the BIOS setup or permit boot device in the boot priority

## 12.2 Problems when using modules of third-party manufacturers

Problem	Possible cause	Remedy
The PC crashes during startup	<ul style="list-style-type: none"> <li>• Double allocation of I/O addresses</li> <li>• Double allocation of hardware interrupts and/or DMA channels</li> <li>• Signal frequencies or signal levels are incorrect,</li> <li>• Connector assignments deviate,</li> <li>• No "Reset Configuration" executed in BIOS SETUP.</li> </ul>	<p>Check your computer configuration:</p> <ul style="list-style-type: none"> <li>• If the computer configuration corresponds with factory state, please contact your technical support team.</li> <li>• If the computer configuration has changed, restore the original factory settings. Remove all third-party modules, then restart the PC. If the error no longer occurs, the third-party module was the cause of the fault. Replace this module with a Siemens module or contact the module supplier.</li> <li>• Force a "Reset Configuration" using the BIOS Setup.</li> </ul>
		Contact Technical Support if the PC still crashes.
<ul style="list-style-type: none"> <li>• PC does not restart or turns off immediately</li> </ul>	<ul style="list-style-type: none"> <li>• A voltage &gt; 0.5 V is fed into the PC due to connected or installed third-party components</li> </ul>	<p>Check with the supplier of the component</p> <ul style="list-style-type: none"> <li>• whether this can be operated without an external power supply,</li> <li>• Whether the settings for the component can be changed so that only the PC power supply is used or only the external power supply.</li> </ul>



## Specifications

### 13.1 General specifications

<b>General specifications</b>	
Order numbers	6AG4104-0...(for details, refer to the ordering documentation)
Dimensions	433.5 x 176.5 x 445.5 (WxHxD in mm) Detailed dimension specifications are found in the "Dimension drawings" section.
Weight	Min. 16 kg, max. 23 kg
Supply voltage ( $V_N$ )	100 V to 240 V AC (90 to 264 V AC)
Input current AC	Continuous current up to 7 A (during startup up to 30 A for the duration of 5 ms)
Frequency	50 – 60 Hz (min. 47 Hz to max. 63 Hz, sinusoidal)
Transient voltage interruption	16 ms at 0.85 $U_N$ (max. 10 events per; min. recovery time 1s)
Power consumption (with 210 W secondary)	310 W (approx 68% efficiency)
Max. current output (AC)	+3.3 V/24 A +5V/26A max. 190 W total allowed -12V/15 +12V/15 -12V/0.2A +5Vaux/2A
Noise emission	< 45 dB (A) to DIN 45635
Degree of protection	IP 30 with closed front door, IP 20 at the back in conformity to EN 60529
Dust protection	With the front panel closed according to IEC 60529 Filter class G2 EN 779, 99 % of particles > 0.5 mm are filtered
Pollution gas	EN 60721-3-3;1995 class 3C2 Sulphur dioxide and hydrogen sulphide class 3C3
<b>Security</b>	
Protection class	Protection class I compliant with IEC 61140
Safety regulations	EN60950-1, UL60950, CSA C22.2 No 60950-00

13.1 General specifications

<b>General specifications</b>	
<b>Electromagnetic compatibility (EMC)</b>	
Emitted interference (AC)	EN 55022 Class A, FCC class A EN 61000-3-2 Class D, EN 61000-3-3
Noise immunity: Mains borne disturbance variables on supply lines	± 2 kV; (conforms to IEC 61000-4-4; Burst) ± 1 kV; (conforms to IEC 61000-4-5; Surge sym) ± 2 kV; (conforms to IEC 61000-4-5; Surge asym)
Noise immunity on signal lines	± 2 kV; (conforms to IEC 61000-4-4; Burst; length < 3 m) ± 2 kV; (conforms to IEC 61000-4-5; Surge sym, length > 30 m)
Immunity to discharges of static electricity	± 4 kV, contact discharge (to IEC 61000-4-2) ± 8 kV, atmospheric discharge (to IEC 61000-4-2)
Immunity to RF interference	1 V/m, 2-2.7 GHz 10 V/m, 80-1000 MHz und 1.4 - 2 GHz, 80% AM; (conforms to IEC 61000-4-3) 10 V, 10 kHz-80 MHz; (conforms to IEC 61000-4-6)
Magnetic field	100 A/m, 50 Hz / 60 Hz; (to IEC 61000-4-8)
<b>Climatic conditions</b>	
Temperature	Tested to IEC 60068-2-2, IEC 60068-2-1, IEC 60068-2-14,
- In operation  - Gradient - Storage/transport - Gradient	+ 5° to + 40° C without burner operation, + 5° to + 35° C with restriction CPU up to 65W power loss See "Retrofitting instructions" max. 10° C/h no condensation - 20° to +60° C max. 20°C/h no condensation
Relative humidity	Tested to IEC 60068-2-78, IEC 60068-2-30
- In operation - Gradient - Storage/transport - Gradient	5% to 80% at 25 °C (no condensation) max. 10°C/h no condensation 5% to 95% at 25 °C (no condensation) max. 20°C/h no condensation
<b>Mech. Ambient conditions</b>	
Vibration - Operation <sup>1</sup> Storage/transport	Tested to IEC 60068-2-6, 10 cycles 20 - 58 Hz, Amplitude 0.015mm; 58 to 200 Hz: 2m/s <sup>2</sup> 5 - 8.51 Hz, Amplitude 3.5 mm; 8.51 to 500 Hz: 9.8 m/s <sup>2</sup>
Shock resistance - Operation <sup>1</sup> - Storage/transport	tested to DIN IEC 60068-2-27 half sine: 9,8 m/s <sup>2</sup> , 20 ms, 100 shocks per axis half-sine: 250 m/s <sup>2</sup> , 6 ms, 1000 shocks per axis
<b>Special features</b>	
Quality assurance	to ISO 9001
<b>Motherboard</b>	
Processor	Design: LGA 775 Intel® Core™ 2 Duo E6600 (2.4 GHZ, 1066 MHz FSB, 4 MB L2C, EM64T, VT) Intel® Core™ 2 Duo E4300 (1.8 GHZ, 800 MHz FSB, 2 MB L2C, EM64T) Intel® Celeron® 440 (2.0 GHZ, 800 MHz FSB, 512 KB L2C)

<b>General specifications</b>	
Chipset	Intel 945G
RAID (on-board)	Intel ICH7R with Intel storage manager software
Main memory	4 DIMM slots maximum 4 GB DDR 2 667 SDRAM (PC 2 5300)
Memory expansion	512 MB to 4 GB, max. 3.2 GB can be used for operating system and applications. (See ordering documentation for features)
Expansion slots	4 x PCI 2 x PCIe x1 1 x PCIe x16 All modules up to 312 mm in length are supported
max. permissible power consumption PCIe x1 slot	PCIe x1 modules: 3.3V 3A, 12V 2.1A; 3.3Vaux 0.4A
max. permissible power consumption PCIe x16 slot	PCIe x16 module: 3.3V 3A; 12V 2.1A; 3.3Vaux 0.4A
Max. permissible power consumption per PCI slot	5V 5A or 3.3V 7A, 12V 0.5 A, -12V 0.05 A; 3.3 Vaux 0.4A
Max. accumulated power loss per PCI slot	Accumulated power loss (all voltages) may not exceed 25 W.
PCI modules with exclusively 5V supply	The total consumption of all modules may not exceed 25W
Max. permissible power loss at all slots	Total power consumption of 80 W must not be exceeded In total, the 3.3 Vaux current of 1.2 A must not be exceeded
<b>Drives (for configuration details, refer to the order documentation)</b>	
Floppy disk drive	3.5" (1.44 MB)
HDD	3.5" SATA 300, 250 GB
DVD-ROM	5.25" ATAPI Read: DVD ROM: Single layer 16x, Dual Layer 8x DVD+R/RW, DVD-R/RW 8x, DVD-RAM 2x CD-ROM, CD-R 32x, CD-RW 20x
DVD burner	5.25" ATAPI Read: DVD-ROM: Single Layer 16x, Dual Layer 12x DVD-R/+R: Single Layer 16x, Dual Layer 7x DVD-RW/+RW 13x CD-ROM/CD-R 48x, CD-RW 40x Writing: DVD+R 18x, DVD+RW 8x, DVD-R 18x, DVD-RW 6x, DVD+R9 (DL) 8x, DVD-R DL 8x CD-R 48x, CD-RW 32x
<b>Graphics</b>	
Graphics controller	Intel® GMA950 graphics controller, chipset integrated 2-D and 3-D engine, Up to 2048 x 1536 at 75 Hz
Graphics memory	Dynamic Video Memory Technology (uses up to 224 MB of RAM)

13.1 General specifications

<b>General specifications</b>	
Resolutions/frequencies/colors	Up to 800 x 600 at 120 Hz / 32-bit color depth Up to 1280 x 1024 at 100 Hz / 32-bit color depth Up to 2048 x 1536 at 75 Hz / 16-bit color depth
Graphics module (optional)	PCIe x16 graphics adapter, Dual Head (2x VGA or 2x DVI) Type: PNY NVS 285 (128 MB graphics memory)
<b>Ports</b>	
COM1	Serial interface 1 (V.24), 9-pin D-sub connector
COM2 (optional)	Serial interface 2 (V.24), 9-pin D-sub connector
LPT1	Parallel interface (Standard, EPP and ECP mode) Connection for parallel port printer
VGA internal As an alternative PCIe x16 dual head	Connection of an analog monitor Connection of two digital or analog monitors
Keyboard	PS/2 keyboard connection
Mouse	PS/2 mouse connection
USB	6 channels (4 at back, 2 in front) high current, high speed USB 2.0
Ethernet	Broadcom BCM 5751 Ethernet interface (RJ45) 10/100/1000 Mbps
Audio - Mic in - Line in - Line out	Realtek ALC262 Audio Codec  2x 0.5W / 8 Ohm
<b>Approvals</b>	
CE residential area (emitted interference)	EN61000-6-3:2001
CE industrial area (noise immunity)	EN61000-6-2:2005
cULus	60950-1
<b>Status displays (LEDs)</b>	
	POWER HARDDISK STATUS
1	When using a hard disk in a removable cartridge, the device should generally be free of mechanical disturbances. When using a DVD burner, the device should generally be free of mechanical disturbances during burning.



## 13.2 Power requirements of components (maximum values)

### Base system

Components	Voltage				
	+5 V	+3.3 V	+12 V	-12 V	5 Vaux
FSC D2156-S21 motherboard with Processor and heat sink	5 A	0.8 A	12 A	0.01 A	0.5 A
Front fan			0.5 A		
Disk drive	0.25 A				
<b>Base system</b>	<b>5.25 A</b>	<b>0.8 A</b>	<b>12.5 A</b>	<b>0.01 A</b>	<b>0.5 A</b>
<b>Expansions</b>					
Hard disk drive SATA	0.5 A		0.7 A		
DVD-ROM	0.9 A		0.8 A		
DVD burner	1.1 A		1.4 A		
Single lines of current (max. permissible) <sup>1</sup>	26 A	24 A	30 A	0.2 A	2 A
Total power consumption, permissible	200 W				
Efficiency of the power supply	Approx. 68% (230 V AC) / approx. 65% (115 V AC)				
<sup>1</sup> The max. permitted accumulated power of the +5 V and + 3.3 V is 190 W.					

## 13.3 AC voltage supply

### Output voltage

Voltage	Max. current	Voltage stability
+ 12 V	15 A	+/- 5 %
+ 12 V	15 A	+/- 5 %
- 12 V	0.2 A	+/- 10 %
+ 5 V	26 A <sup>1</sup>	+ 5 % / - 4 %
+ 3.3 V	24 A <sup>1</sup>	+ 5 % / - 4 %
+ 5 V aux	2 A	+ 5 % / - 3 %

<sup>1</sup> The accumulated power of the +5 V and + 3.3 V supply may not exceed 190 W

The maximum inrush current is for:

110 V AC: 25 A, 5 ms

230 V AC: 30 A, 5 ms

## 13.4 Technical data of the telescopic rails

Ultimate load per pair	At least 30 kg
Full extraction length	At least 470 mm
Rail thickness	Maximum 9.7 mm
Mounting screws	M5 x 6 mm

The mounting screws of the telescopic rails may not protrude by more than 5 mm into the enclosure.

## Dimension drawings

### 14.1 Dimensional drawing of the device

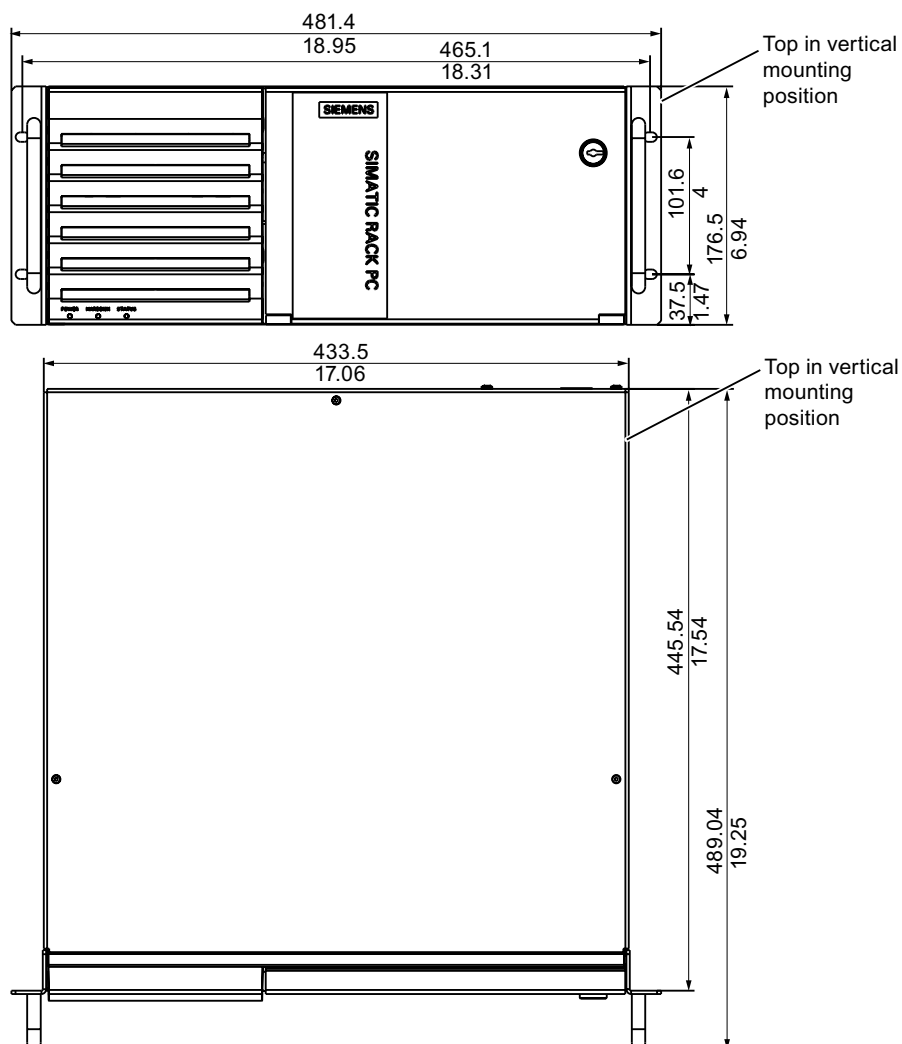

Dimensions:  $\frac{\text{mm}}{\text{Inch}}$

Figure 14-1 Dimension drawing of the device

## 14.2 Dimensional drawing for the use of telescopic rails

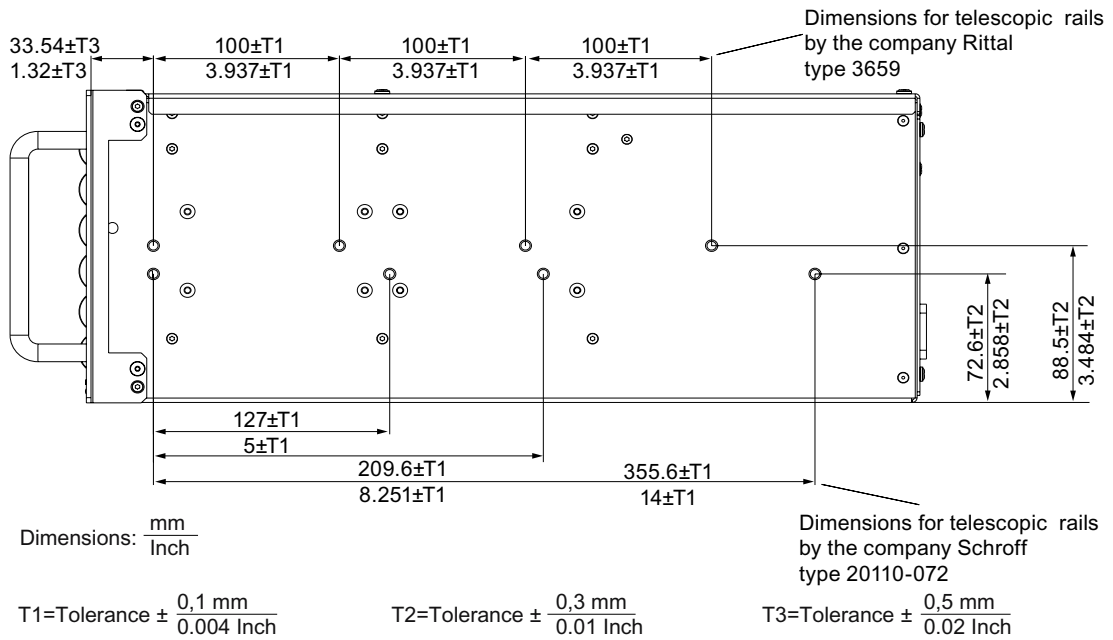
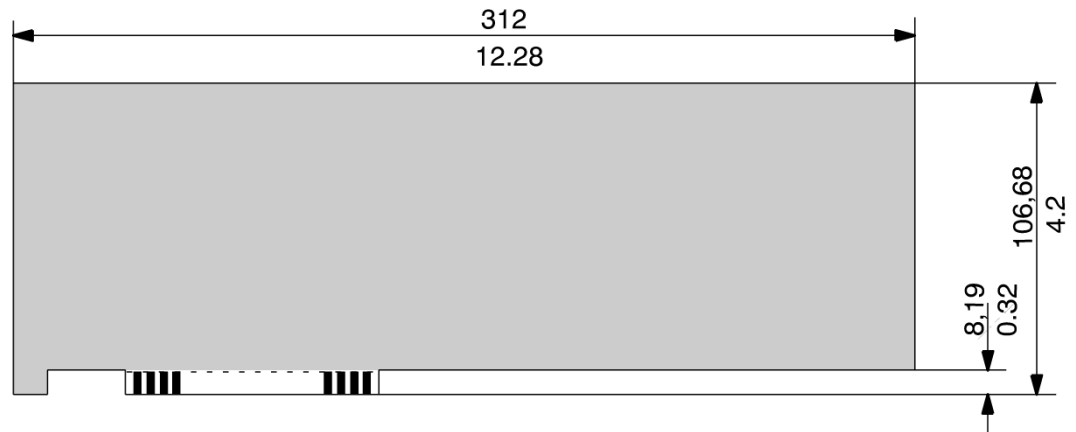

Figure 14-2 Dimension drawing for the use of telescopic rails

### 14.3 Dimensional drawings for the installation of expansion modules



Dimensions:  $\frac{\text{mm}}{\text{Inch}}$

Figure 14-3 Long PCI module, PCIe module



## Detailed descriptions

### 15.1 Motherboard

The motherboard consists of the processor and the chipset, four slots for memory modules, internal and external ports, the Flash BIOS and the backup battery.

You will find a detailed description of the motherboard as well as the available interfaces in the technical manual of the D2156-S motherboard on the supplied "Documentation and Drivers" CD.

### 15.2 System resources

All system resources (hardware addresses, memory configuration, allocation of interrupts, DMA channels) are assigned dynamically by the Windows OS, depending on the hardware configuration, drivers and connected external devices. You can view the current configuration of system resources or possible conflicts with the following operating systems:

Windows 2000, XP or Server 2003	<b>Start &gt; Run</b> : In the <b>Open</b> box, enter "msinfo32" and confirm with <b>OK</b>
Vista	Start > Enter "cmd" in the search function , then enter "msinfo32" in the input box

## 15.3 Interrupt assignments

The functions are assigned different interrupts, depending on the operating system. A distinction is made between the PIC and APIC modes.

X = Interrupt in PIC and APIC mode, Y = Interrupt in APIC mode, Z = BIOS default interrupt in PIC mode (e.g. DOS)

Functions	IRQ number																							Comments										
	0	1	2	3	4	5	6	7	8	9	10	10	11	12	12	13	13	14	14	15	15	16	17		18	19	20	21	22	23				
IRQ (APIC mode)	0	1	2	3	4	5	6	7	8	9	10	10	11	12	12	13	13	14	14	15	15	A	B	C	D	E	F	G	H					
IRQ (PIC mode)	0	1	2	3	4	5	6	7	8	9	10	10	11	12	12	13	13	14	14	15	15	A	B	C	D	E	F	G	H					
Host PCI IRQ line																																		
Functions																						(1)	(2)	(3)	(4)	(5)	(6)	(7)	(8)					
Timer 0	X																																	Fixed
PS/2 keyboard		X																																Fixed
Cascaded (IRQ9)			X																															Fixed
Serial port 2				X																														Can be switched off
Serial port 1					X																													Can be switched off
FD controller						X																												Can be switched off
Parallel port 1							X																											Can be switched off
Real-time clock (RTC)								X																										Can be switched off
PS/2 mouse									X					X																				Fixed, can be disabled
Numeric processor															X																			Fixed
HD controller 1 (primary)																X																		Can be switched off
HD controller 2 (secondary)																	X																	Can be switched off
SATA											Z																							Can be switched off
USB port 0/1											Z																							Can be switched off
USB port 2/3										Z																								Can be switched off
USB port 4/5										Z																	Y							Can be switched off
USB port 6/7						Z																				Y								Can be switched off
USB 2.0 Controller						Z																												Can be switched off
Ethernet 1 (LAN)						Z																		Y										Can be switched off
SMBus						Z							Z																					Can be switched off
VGA						Z																	Y											Can be switched off
HD audio										Z															Y									Can be switched off

1) Host PCI-IRQ line A (1) to H (8) is assigned to IRQ 16 to 23 in APIC mode.  
Host PCI-IRQ line A (1) to H (8) is automatically assigned to IRQ 0 to 15 in PIC mode (BIOS setup mode "auto"), a manual assignment to a particular IRQ can also be forced in the BIOS setup (BIOS setup "Advanced" -> PCI Configuration -> PCI IRQ Line A (1) to H (8) "IRQ 3-7, 9-12, 14-15")



Y = Interrupt in APIC mode, Z = BIOS default interrupt in PIC mode (e.g. DOS)

Functions	IRQ number																							Comments	
	0	1	2	3	4	5	6	7	8	9	10	11	12	13	14	15	16	17	18	19	20	21	22		23
APIC IRQ	0	1	2	3	4	5	6	7	8	9	10	11	12	13	14	15	16	17	18	19	20	21	22	23	
Host PCI IRQ line	0	1	2	3	4	5	6	7	8	9	10	11	12	13	14	15	16	17	18	19	20	21	22	23	
Slot 1 (PEG)						Z											Y								
Slot 2 (PCIe-X1)										Z								Y							
Slot 3 (PCIe-X1)										Z								Y							
Slot 4 (PCI)										Z								Y							
Slot 5 (PCI)										Z								Y							
Slot 6 (PCI)										Z								Y							
Slot 7 (PCI)										Z								Y							

1) Host PCI-IRQ line A (1) to H (8) is assigned to IRQ 16 to 23 in APIC mode.  
Host PCI-IRQ line A (1) to H (8) is assigned to IRQ 0 to 15 automatically in PIC mode (BIOS setup mode "auto"), it is also possible to force manual assignment to a particular IRQ in the BIOS setup.  
(BIOS setup "Advanced" -> PCI Configuration -> PCI IRQ Line A (1) to H (8) "IRQ 3-7, 9-12, 14-15")

### Exclusive PCI hardware interrupt

Applications demanding high-performance interrupt handling require a high-speed hardware interrupt reaction. The PCI hardware interrupt should only be used by one resource in order to ensure high-speed reaction of the hardware.

### Setting up an exclusive interrupt on the device (only APIC mode)

Exclusive interrupts are not available when the device is shipped. An exclusive interrupt can only be used and set for the PCI slots 1 and 2. This requires that the USB 1.1 channels are disabled in the BIOS setup: Advanced > USB Enable Ports > none

Further exclusive interrupts for use at the slots are not available.

### Assigning an exclusive interrupt in BIOS Setup (PIC mode only)

The interrupts are automatically assigned to the slots at system startup due to the default settings in system BIOS.

Depending on the system configuration, it is possible that the same interrupt is assigned to several slots. This functionality is known as interrupt sharing. There is no exclusive interrupt available in PIC mode. Disable specific system resources in order to obtain exclusive interrupts. The resulting free interrupt can be assigned to a PCI slot in the BIOS setup. To do this, change the slot setting from "Auto" to a free interrupt number:

Advanced > PCI Configuration > PCI IRQ Line 1 to 8 > select an interrupt (possible interrupts are IRQ 3-7, 9-12, 14-15).

### Example:

You require an exclusive IRQ for slot 4 and serial port 2 is not used.

1. Disable serial port 2, so that IRQ3 becomes free  
Advanced > PCI Configuration > Serial 2: disabled
2. Assign IRQ 3 to slot 4  
Advanced > PCI Configuration > IRQ 3

## 15.4 BIOS Setup

You can configure the system functions and hardware configuration in the BIOS.

The BIOS is set to a default state suitable to the respective device configuration prior to delivery. The most important settings are shown in the table below.

Tab	Option	Setting
Main	Boot Options -> Post Errors	No halt on any errors
	Boot Options -> Quiet Boot	Disabled
Advanced	Peripheral Configuration ->USB BIOS Supported Devices	All
	Peripheral Configuration -> ATA Controller Config > S-ATA Mode	RAID (optional for RAID systems)
	Peripheral Configuration -> LAN Remote Boot	Disabled
	Advanced System Configuration -> Core Multi-Processing	Disabled (on Windows 2000 systems)
Power	System Mode Config.	Performance
	APM Interface	Disabled
	APM Power saving	Disabled
	ACPI Save to RAM	Disabled
	Power failure recovery	Always on

The BIOS reference manual on the supplied "Documentation & Drivers" CD shows you how to access and change the BIOS setup. The manual also contains detailed descriptions of the menus and setting options offered by the BIOS setup.

NOTICE
<p>Updating the BIOS or calling the "Default settings" function changes the BIOS settings. Pay special attention to the correct settings in the "Power" tab.</p> <p>All menu items are set to "Disabled" by default.</p> <p>The operating system functions "Save to RAM" (standby) and "Save to Disk" (hibernate) are not approved for the Rack PC.</p>



## Appendix

### A.1 Guidelines and declarations

#### Notes on the CE Label

**CE** The following applies to the SIMATIC product described in this documentation:

#### EMC guideline

This product fulfills the requirements for the EC directive "89/336/EEC Electromagnetic Compatibility", and the following fields of application apply according to this CE label:

Scope of application	Requirements for	
	Interference emission	Immunity to interference
Industrial area	EN 61000-6-4 : 2001	EN 61000-6-2 : 2005
Residential and commercial areas and small businesses	EN 61000-6-3 : 2001	EN 61000-6-1 : 2001

The devices conform with EN 61000-3-2:2000 (harmonics) and EN 61000-3-3:1995+A1:2001 (voltage fluctuations and flicker).

#### Low-voltage guideline

The devices complies with the requirements of the EC Directive 2006/95/EC "Low Voltage Directive". Conformance with this standard has been verified according to EN 60950-1.

#### Conformity certificates

The EC declaration of conformity and the corresponding documentation are made available to authorities in accordance with the EC directives stated above. Your local sales representative can provide these on request.

#### Observing the installation guidelines

The installation guidelines and safety instructions specified in this documentation must be observed for commissioning and operation.

**Connecting peripherals**

Noise immunity requirements to EN 61000-6-2 are met if connected peripherals are suitable for industrial applications. Peripheral devices may only be connected via shielded cables.

**A.2 Certificates and Approvals**

**DIN ISO 9001 certificate**

The Siemens quality management system for all production processes (development, production and sales) meets DIN ISO 9001:2000 requirements.

This has been certified by DQS (the German society for the certification of quality management systems).

EQ-Net certificate no.: DE-001108 QM

**Software License Agreement**

The device is shipped with preinstalled software. Please observe the respective license agreements.

**Certification for the USA, Canada and Australia**

**Security**

<b>The following approval is available for the device:</b>	
	Underwriters Laboratories (UL) to Standard UL 60950-1, Report E11 5352 and Canadian National Standard CAN/CSA-C22.2 No. 60950-1 (I.T.E)

**EMC**

<b>USA</b>	
Federal Communications Commission Radio Frequency Interference Statement	This equipment has been tested and found to comply with the limits for a Class A digital device, pursuant to Part 15 of the FCC Rules. These limits are designed to provide reasonable protection against harmful interference when the equipment is operated in a commercial environment. This equipment generates, uses, and can radiate radio frequency energy and, if not installed and used in accordance with the instruction manual, may cause harmful interference to radio communications. Operation of this equipment in a residential area is likely to cause harmful interference in which case the user will be required to correct the interference at his own expense.
Shielded cables	Shielded cables must be used with this equipment to maintain compliance with FCC regulations.

<b>USA</b>	
Modifications	Changes or modifications not expressly approved by the manufacturer could void the user's authority to operate the equipment.
Conditions of operations	This device complies with Part 15 of the FCC Rules. Operation is subject to the following two conditions: (1) this device may not cause harmful interference, and (2) this device must accept any interference received, including interference that may cause undesired operation.

<b>CANADA</b>	
Canadian notice	This Class A digital apparatus complies with Canadian ICES-003.
Avis Canadian	Cet appareil numérique de la classe B est conforme à la norme NMB-003 du Canada.

<b>AUSTRALIA</b>	
	This product meets the requirements of the AS/NZS CISPR 22 Standard.

## A.3 Service and support

### Local information

If you have questions about the products described in this document, you can find help at:  
<http://www.siemens.com/automation/partner>

### Technical documentation for SIMATIC products

Further documentation for SIMATIC products and systems can be found at:  
<http://www.siemens.de/simatic-tech-doku-portal>

### Easy shopping with the A&D Mall

Catalog & online ordering system <http://www.siemens.com/automation/mall>

### Training

All the training options are listed at: <http://www.siemens.com/sitrain>  
Find a contact at: Phone: +49(911) 895-3200

### Technical support

Tel +49 180 5050 222  
Fax +49 180 5050 223  
<http://www.siemens.com/automation/service>

You will find support request web form at:  
<http://www.siemens.de/automation/support-request>

When you contact the customer support, please have the following information for the technician on hand:

- BIOS version
- Order No. (MLFB) of the device
- Installed additional software
- Installed additional hardware

### Online support

Information about the product, Support and Service, right through to the Technical Forum, can be found at: <http://www.siemens.com/automation/service&partner>

### After-sales information system for SIMATIC PC / PG

Information about contacts, drivers, and BIOS updates, FAQs and Customer Support can be found at: <http://www.siemens.com/asis>



## A.4 Retrofitting instructions

The section below describes the approved variants of the drive configuration for Rack PC 547B and the resultant operating conditions.

### Approved configuration versions for the temperature range 5 to 35° C

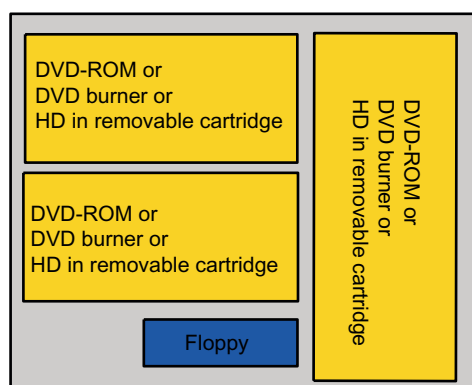

Figure A-1 For the temperature range 5 to 35° C

A removable cartridge with hard disk can be installed instead of DVD drive(s).

Devices equipped with removable cartridges may not to be exposed to shock during operation as described by DIN IEC 600682.

### Approved configuration versions for the temperature range 5 to 40° C

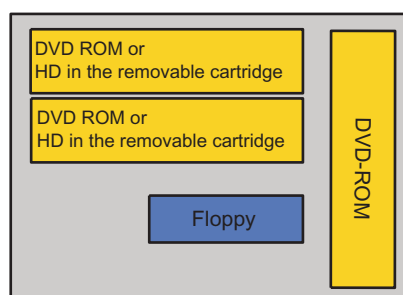

Figure A-2 For the temperature range 5 to 40° C

A removable cartridge with hard disk can be installed instead of DVD drive(s).

Devices equipped with removable cartridges may not to be exposed to shock during operation as described by DIN IEC 600682.



## ESD directives

### B.1 ESD guidelines

#### Definition of ESD

All electronic modules are equipped with large-scale integrated ICs or components. Due to their design, these electronic elements are highly sensitive to overvoltage, and thus to any electrostatic discharge.

The electrostatic sensitive components/modules are commonly referred to as ESD devices. This is also the international abbreviation for such devices.

ESD modules are identified by the following symbol:



#### CAUTION

ESD devices can be destroyed by voltages well below the threshold of human perception. These static voltages develop when you touch a component or electrical connection of a device without having drained the static charges present on your body. The electrostatic discharge current may lead to latent failure of a module, that is, this damage may not be significant immediately, but in operation may cause malfunction.

### Electrostatic charging

Anyone who is not connected to the electrical potential of their surroundings can be electrostatically charged.

The figure below shows the maximum electrostatic voltage which may build up on a person coming into contact with the materials indicated. These values correspond to IEC 801-2 specifications.

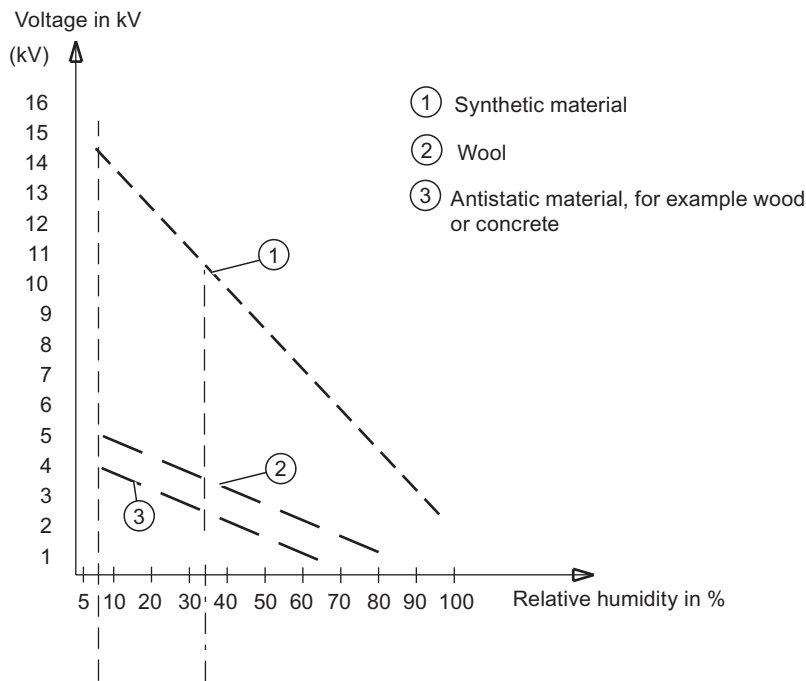

Figure B-1 Electrostatic voltages on an operator

### Basic protective measures against electrostatic discharge

- Ensure good equipotential bonding:  
When handling electrostatic sensitive devices, ensure that your body, the workplace and packaging are grounded. This prevents electrostatic charge.
- Avoid direct contact:  
As a general rule, only touch electrostatic sensitive devices when this is unavoidable (e.g. during maintenance work). Handle the modules without touching any chip pins or PCB traces. In this way, the discharged energy can not affect the sensitive devices.

Discharge your body before you start taking any measurements on a module. Do so by touching grounded metallic parts. Always use grounded measuring instruments.

## List of abbreviations/acronyms

### C.1 Abbreviations

Abbreviation	Term	Meaning
AC	Alternating current	Alternating current
ACPI	Advanced Configuration and Power Interface	
PLC	Programmable controller	
AGP	Accelerated Graphics Port	High speed bus system
AHCI	Advanced Host Controller Interface	Controller interface for SATA devices. Supported in Microsoft Windows XP as of SP1 and IAA driver.
APIC	Advanced Programmable Interrupt Controller	Extended programmable interrupt controller
APM	Advanced Power Management	Tool for monitoring and reducing power consumption of the PC
AS	Automation system	
ASIS	After Sales Information System	
AT	Advanced Technology	
ATA	Advanced Technology Attachment	
ATX	AT-Bus-Extended	
AWG	American Wire Gauge	US standard for the cable diameter
BIOS	Basic Input Output System	Basic Input Output System
CAN	Controller Area Network	
CD-ROM	Compact Disc – Read Only Memory	Removable storage medium for large data volumes
CD-RW	Compact Disc – Rewritable	Rewritable CD
CE	Communauté Européenne (CE symbol)	The product is in conformance with all applicable EC directives
CF	Compact Flash	
CGA	Color Graphics Adapter	Standard monitor interface
CLK	Clock pulse	Clock signal for controllers
CMOS	Complementary Metal Oxide Semiconductors	Complementary metal oxide semiconductors
COA	Certificate of authentication	Microsoft Windows Product Key

List of abbreviations/acronyms

C.1 Abbreviations

Abbreviation	Term	Meaning
CoL	Certificate of License	License authorization
COM	Communications Port	Term for the serial interface
CP	Communication Processor	Communication computer
CPU	Central Processing Unit	CPU
CRT	Cathode Ray Tube	
CSA	Canadian Standards Association	Canadian organization for tests and certifications according to own or binational standards (with UL / USA) standards
CTS	Clear To Send	Clear to send
DRAM	Dynamic Random Access Memory	
DC	Direct Current	DC current
DCD	Data Carrier Detect	Data carrier signal detection
DMA	Direct Memory Access	Direct memory access
DOS	Disk Operating System	Operating system without GUI
DP	Distributed I/Os	
DQS	Deutsche Gesellschaft zur Zertifizierung von Qualitätsmanagement mBH	
DDRAM	Double Data Random Access Memory	Memory chip with high-speed interface
DSR	Data Set Ready	Ready for operation
DTR	Data Terminal Ready	Data terminal is ready
DVD	Digital Versatile Disk	Digital versatile disk
DVI	Digital Visual Interface	Digital display interface
DVI-I	Digital Visual Interface	Digital display interface with digital and VGA signals
ECC	Error Correction Code	Error correction code
ECP	Extended capability port	Extended parallel port
EGA	Enhanced Graphics Adapter	PC to monitor interface
ESD	Components sensitive to electrostatic charge	
DM	Electronic Manual	
EIDE	Enhanced Integrated Drive Electronics	An enhancement of the IDE standard
EISA	Extended Industry Standard Architecture	Extended ISA standard
EMM	Expanded Memory Manager	Manages memory expansions
EM64T	Extended Memory 64 technology	
EN	European standard	
EPROM / EEPROM	Erasable Programmable Read-Only Memory / Electrically Erasable Programmable Read-Only Memory	Plug-in submodules with EPROM/EEPROM chips
EPP	Enhanced Parallel Port	Bi-directional Centronics interface
ESC	Escape character	Control character
EWf	Enhanced Write Filter	
FAQ	Frequently Asked Questions	FAQs
FAT 32	File Allocation Table 32-bit	32-bit file allocation table
FD	Floppy disk	Disk drive, 3.5"

Abbreviation	Term	Meaning
FSB	Front Side Bus	
GND	Ground	Chassis ground
HD	Hard disk	Hard disk
HDA	High Definition Audio	
HDD	Hard Disk Drive	HDD
HU	Height unit	
HMI	Human Machine Interface	User interface
HT	Hyper-Threading	
HTML	Hyper Text Markup Language	Script language for creating Internet pages.
HTTP	Hypertext Transfer Protocol	Protocol for data transfer on the Internet
Hardware	Hardware	
I/O	Input/Output	Data input/output on computers
IAA	Intel Application Accelerator	
IDE	Integrated Device Electronics	
IEC	International Electrotechnical Commission	
IP	Ingress Protection	Degree of protection
IR	Infrared	Infrared
IRDA	Infrared Data Association	Standard for data transfer via IR module
IRQ	Interrupt Request	Interrupt request
ISA	Industry Standard Architecture	Bus for expansion modules
ITE	Information Technology Equipment	
L2C	Level 2 cache	
LAN	Local Area Network	Computer network that is limited to a local area.
LCD	Liquid Crystal Display	Liquid crystal display
LEDs	Light Emitting Diode	Light emitting diode
LPT	Line Printer	Printer port
LVDS	Low Voltage Differential Signaling	
LW	Drive	
MAC	Media access control	Media access control
MC	Memory Card	Memory card in credit card format
MLFB	Machine-readable product designation	
MMC	Micro Memory Card	Memory card of the format 32 mm x 24.5 mm
MPI	Multipoint-capable interface for programming devices	
MS-DOS	Microsoft Disc Operating System	
MTBF	Mean Time Between Failures	
MUI	Multilanguage User Interface	Language localization in Windows
NA	Not Applicable	
NAMUR	Normenarbeitsgemeinschaft für Mess- und Regelungstechnik in der chemischen Industrie (standardization body for instrumentation and control technology in the chemicals industry)	

List of abbreviations/acronyms

C.1 Abbreviations

Abbreviation	Term	Meaning
NC	Not Connected	Not connected
NCQ	Native Command Queuing	Automatic re-sorting of the file and disk access, for increased performance
NEMA	National Electrical Manufacturers Association	Syndicate of manufacturers of electrical components in the USA
NMI	Non Maskable Interrupt	Interrupt the processor can not reject
NTFS	New Techniques File System	Secure file system for Windows versions (2000, XP, Vista)
ODD	Optical Disk Drive	
OPC	OLE for Process Control	Standardized interface for industrial processes
PATA	Parallel ATA	
PC	Personal computer	
PCI	Peripheral Component Interconnect	High-speed expansion bus
PCIe	Peripheral Component Interconnect express	High-speed serial, differential full-duplex PtP interface with high data rate.
PCMCIA	Personal Computer Memory Card International Association	
PE	Protective Earth	Protective conductor
PEG	PCI Express Graphics	
PG	Programming device	
PIC	Programmable Interrupt Controller	Programmable interrupt controller
POST	Power On Self Test	
PXE	Preboot Execution Environment	Software for running new PCs without hard disk data via the network
RAID	Redundant Array of Independent Disks	Redundant hard disk array
RAM	Random Access Memory	
RI	Ring Input	Incoming call
ROM	Read-Only Memory	
RS 485	Reconciliation Sublayer 485	Bi-directional bus system designed for up to 32 nodes
RTC	Real Time Clock	Real-time clock
RTS	Reliable Transfer Service	Request to send
RxD	Receive Data	Data transfer signal
SATA	Serial Advanced Technology Attachment	
SCSI	Small Computer System Interface	
SDRAM	Synchronous DRAM	
SELV	Safety Extra Low Voltage	Safety extra low voltage
SLC	Second Level Cache	
SMART	Self Monitoring Analysis and Reporting Technology	Hard disk error diagnostics program
SMS	Short Message Service	Short message via telecommunication network
SNMP	Simple Network Management Protocol	Network protocol
SO-DIMM	Small Outline Dual Inline Memory Module	
SOM	SafeCard on Motherboard (SOM)	



Abbreviation	Term	Meaning
SPP	Standard Parallel Port	Synonym for parallel port
SVGA	Super Video Graphics Array	Enhanced VGA standard with at least 256 colors
SVP	Serial number of the device	
SW	Software	
TCO	Total Cost of Ownership	
TFT	Thin-Film-Transistor	Type of LCD flat-screen
TTY	Tele Type	Asynchronous data transfer
TxD	Transmit Data	Data transfer signal
TWD	Watchdog Time	Watchdog monitoring time
UL	Underwriters Laboratories Inc.	US organization for tests and certifications according to own or binational standards (with CSA / Canada) standards
UMA	Unified Memory Architecture	Video memory
URL	Uniform Resource Locator	Designation of the full address of an Internet page
USB	Universal Serial Bus	
UXGA	Ultra Extended Graphics Array	Graphic standard, maximum resolution 1600x1200 pixels.
V.24		ITU-T standardized recommendation for data transfer via serial ports
VDE	Verein deutscher Elektrotechniker (Union of German Electrical Engineers)	
VGA	Video Graphics Array	Video adapter which meets industrial standard
VRM	Voltage Regulator Module	
W2k	Windows 2000	
WAV	Wave Length Encoding	Loss-free file format for audio data
WD	Watchdog	Program monitoring with error detection and alarming.
WLAN	Wireless LAN	Wireless local area network
WWW	World Wide Web	
XGA	Extended Graphics Array	Graphic standard, maximum resolution 1024x768 pixels.



# Glossary

## **ATAPI CD-ROM Drive**

AT Bus Attachment Packet Interface (connected to AT bus) CD-ROM drive

## **Automation system (AS)**

A programmable controller (PLC) of the SIMATIC S7 system consist of a central controller, one or several CPUs, and various I/O modules.

## **Backup**

Duplicate of a program, data medium or database, used either for archiving purposes or for the protection of vital and non-replaceable data against loss when the working copy is corrupted. Certain applications automatically generate backup copies of data files, and manage both the current and the previous versions on the hard disk.

## **Baud**

Physical unit for the step speed in signal transmission. Defines the number of transferred signal states per second. With only two states, one baud is equivalent to a transmission rate of 1 bps.

## **BEEP code**

If the BIOS detects a boot error, it outputs an audible warning based on the current test result

## **Boot disk**

A boot disk is a bootstrap disk with "Boot" sector. This can be used to load the operating system from the disk.

## **Booting**

Start or restart of the computer. During booting the operating system is transferred from the system data medium to the work memory.

## **Cache**

High-speed access buffer for interim storage (buffering) of requested data.

### **CE label**

**Communauté Européene** The CE mark confirms compliance of the product with corresponding EC Directives, for example, with the EMC Directive.

### **Chipset**

Located on the motherboard, connects the processor with the RAM, the graphics controller, the PCI bus, and the external interfaces.

### **Cold restart**

A start sequence, starting when the computer is switched on. The system usually performs some basic hardware checks within the cold start sequence, and then loads the operating system from the hard disk to work memory -> boot

### **COM interface**

The COM interface is a serial V.24 interface. The interface is suitable for asynchronous data transfer.

### **Compact Flash cards (CF)**

Compact Flash is a digital storage medium in card format and without moving parts. The CF card contains the non-volatile memory and the controller. The interface of the CF card corresponds with the IDE interface. CF cards can be operated without additional electronics on PCMCIA or IDE hard disk controllers using a plug and socket adapter. There are two design forms: CF-I (42.6 x 36.4 x 3.3 mm) and CF-II (42.8 x 36.4 x 5 mm).

### **Configuration files**

These are files containing data which define the configuration after restart. Examples of such files are CONFIG.SYS, AUTOEXEC.BAT and the registry files .

### **Configuration software**

The configuration software updates the device configuration when new modules are installed . This is done either by copying the configuration files supplied with the module or by manual configuration using the configuration utility.

### **Controller**

Integrated hardware and software controllers that control the functions of certain internal or peripheral devices (for example, the keyboard controller).

**Device configuration**

The configuration of a PC or programming device contains information on hardware and device options, such as memory configuration, drive types, monitor, network address, etc. The data are stored in a configuration file and enable the operating system to load the correct device drivers and configure the correct device parameters. . If changes are made to the hardware configuration, the user can change entries in the configuration file using the SETUP program. .

**Disc-at-once**

With this burning technique, data are written to a CD in a single session, and the CD is then closed. Further write access is then no longer possible.

**Drivers**

Program parts of the operating system. They adapt user program data to the specific formats required by I/O devices such as hard disk, printers, and monitors.

**Dual Core CPU**

Dual-core processors significantly increase the speed of computing and program execution compared to the previous generation of single-core processors with hyperthreading technology.

**EMC directive**

Directive concerning **E**lectromagnetic **C**ompatib**l**ity. Compliance is confirmed by the CE symbol and the EC certificate of conformity.

**Energy management**

The energy management functions of a modern PC allow individual control over the current consumption of vital computer components (e.g. of the monitor, hard disk and CPU), by restricting their activity based on the current system or component load. Energy management is of particular importance for mobile PCs.

**Energy options**

The energy options can be used to reduce energy consumption of the computer, while keeping it ready for immediate use. This can be configured in Windows by selecting Settings > Control Panel > Energy options.

**Enhanced Write Filter (EWF)**

Configurable write filter that allows you, for example, to boot Windows XP Embedded from write-protected media (such as CD-ROM), to write protect individual partitions and adapt the performance of the file system to your needs (when using Compact Flash cards).

### **ESD directive**

Directive for using electrostatic sensitive components.

### **Ethernet**

Local network (bus structure) for text and data communication with a transfer rate of 10/100 Mbps.

### **Formatting**

Basic partitioning of memory space on a magnetic data medium into tracks and segments. Formatting deletes all data on a data medium. All data media must be formatted prior to their first use.

### **Gender changer**

Using the gender changer (25-pin / 25-pin), the COM1/V24/AG interface of the SIMATIC PC family can be converted to the usual 25-pin male connector.

### **Hard disk drives**

Hard disks represent a form of magnetic disk storage medium (Winchester drives, hard disks) with integrated magnetic disks.

### **Hot swapping**

The SATA interface gives the device's hard drive system hot-swap capability. Prerequisite for this configuration is a RAID1 system with SATA RAID controller (on-board, or slot module), and at least two SATA removable cartridges. The advantage of hot swapping is that defective hard disks can be replaced without having to reboot the computer.

### **Hub**

A term in network technology. In a network, a device joining communication lines at a central location, providing a common connection to all devices on the network.

### **Hyper Threading**

HT technology (multi-threading) enables the parallel computing of processes. HT is only effective when all relevant system components, such as processors, operating systems and applications are supported.

### **Image**

This refers to the image, for example, of hard disk partitions saved to a file in order to restore them when necessary.

**Interface**

see Interface

- Physical interconnection (cable) of hardware elements such as PLCs, PCs, programming devices, printers or monitors.
- Interface for interactive software applications.

**Interface**

see Interface

- Physical interconnection (cable) of hardware elements such as PLCs, PCs, programming devices, printers or monitors.
- Interface for interactive software applications.

**Interface, multi-point**

MPI is the programming interface of SIMATIC S7/M7. Allows remote access to programmable modules, text-based displays and OPs from central locations. The MPI nodes can intercommunicate.

**LAN**

**Local Area Network:** LAN is a local network that consists of a group of computers and other devices that are distributed across a relatively restricted range and are linked with communication cables. The devices connected to a LAN are called nodes. The purpose of networks is the mutual use of files, printers or other resources.

**Legacy USB support**

Support of USB devices (e.g. mouse, keyboard) on the USB ports without driver.

**License key**

The license key represents the electronic license stamp of a license. Siemens provides the license keys for protected software.

**License key disk**

The license key disk contains the authorizations or license keys required to enable protected SIMATIC software.

**Low-voltage directive**

EC Product Safety Directive relating to the safety of products which are operated on low voltage (50 VAC to 1000 VAC, 70 VDC to 1500 VDC) and not specified in other directives. Compliance is confirmed by the CE symbol and the EC certificate of conformity.

### **LPT interface**

The LPT interface (Centronics interface) is a parallel interface that can be used to connect a printer.

### **Memory card**

Memory cards in credit card format. Memory for user programs and parameters, for example, for programmable modules and CPs.

### **Module**

Modules are plug-in units for PLCs, programming devices or PCs. They are available as local modules, expansion modules, interfaces or mass storage (Mass storage module).

### **Module retainer**

The module retainer is used to fasten modules and ensure safe contact and transport. Shocks and vibrations especially affect large, heavy modules. It is therefore recommended to use the module retainer for this type of module. There are also short, compact and light modules on the market. The module retainer was not designed for these modules because the standard fastening is sufficient for them.

### **Motherboard**

The motherboard is the core of the computer. Here, data are processed and stored, and interfaces and device I/Os are controlled and managed.

### **NEC Class 2**

The "NEC", National Electrical Code, is the USA collection of regulations that generally correspond to German VDE 0100 standards. All USA standards governing the safety of electrical equipment and corresponding "deviations" in IEC standards are based on NEC in terms of their country-specific requirements.

NEC Class 2 specifies higher safety requirements for protection against electric shock and National Fire Protection Association (NFPA) requirements for fire protection. Power supplies operating within the range from 20 VDC to 30 VDC must be equipped with an internal current limiting circuit which safely prevents output power higher than 100 VA.

### **Operating system**

Generic term which describes all functions for controlling and monitoring user program execution, distribution of system resources to the user programs and the operating mode in cooperation with the hardware (for example Windows XP Professional).



## Packet writing

The CD-RW is used as a disk medium. The CD can then be read only by packet-writing compatible software or has to be finalized. Finalization of a CD closes the CD within an ISO9660 shell. You can still write to the CD-RW several times in spite of finalization. Not all CD drives can read packet-written CDs. There are restrictions to using this method in general data transfer.

## PATA

Interface for hard disk drives and optical drives, with parallel data transmission rate up to 100 Mbps.

## PC card

Trademark of the Personal Computer Memory Card International Association (PCMCIA). Designation for auxiliary cards that conform with PCMCIA specifications. A PC card that has roughly the size of a credit card can be plugged into a PCMCIA slot. Version 1 specifies cards of Type I with a thickness of 3.3 millimeters, which are designed mainly for use as external memory. Version 2 of the PCMCIA specification also defines cards of Type II with a thickness of 5 mm and cards of Type III with a thickness of 10.5 mm. Type II cards can realize devices such as modems, fax cards and network interface cards. Type III cards are equipped with devices that require more space, for example wireless communication modules, or rotary storage media such as hard disk drives, for example.

## PC/104 / PC/104-Plus

Two bus architectures are especially fashionable today in the industrial world. PC/104 and PC/104-*Plus*. Both are standard in single-board computers of the PC class. The electrical and logical layout of the two bus systems is identical with ISA (PC/104) and PCI (PC/104-*Plus*). Software cannot usually detect a difference between them and normal desktop bus systems. Their advantage is the compact design and the resulting space they save.

## PCMCIA

Association consisting of approx. 450 member companies of the computer industry whose focus is set on providing worldwide standards for miniaturization and flexible use of PC expansion cards in order to provide basic technologies to the market.

## Pixel

**PixElement** (picture point). The pixel represents the smallest element that can be reproduced on-screen or on a printer.

## Plug&Play

Generally, a reference to the ability of a computer to automatically configure the system for communication with peripheral devices (for example monitors, modems or printers). The user can plug in a peripheral and "play" it at once without manually configuring the system. A Plug&Play PC requires both a BIOS that supports Plug&Play and a Plug&Play expansion card.

## POST

Self-test performed by the BIOS after the computer is switched on. Performs a RAM test and a graphics controller test, for example. The system outputs audible signals (beep codes) if the BIOS detects any errors; the relevant message indicating cause of error is output on the screen.

## PROFIBUS/MPI

**Process Field Bus** (standard bus system for process applications)

## Programmable controller (PLC)

The programmable controllers (PLC) of the SIMATIC S5 system consist of a central controller, one or more CPUs, and various other modules (e.g. I/O modules).

## PXE server

A **Preboot Execution Environment** server is part of a network environment and can provide software to connected computers even before they boot. This can involve operating system installations or servicing tools, for example.

## RAID

**Redundant Array of Independent Disks**: Data storage system which is used to save data and the corresponding error correction codes (parity bits, for example) to at least two hard disk volumes in order to enhance reliability and performance. The hard disk array is controlled by management programs and a hard disk controller for error correction. The RAID system is usually implemented in network servers.

## Recovery CD

Contains the tools for configuring hard disks and the Windows operating system.

## Reset

Hardware reset: Reset/restart of the PC using a button/switch.

## Restart

Warm restart of a computer without switching the power off (Ctrl + Alt + Del)

## Restore DVD

The Restore DVD is used to restore the system partition or the entire hard disk to factory state if the system has crashed. The bootable DVD contains all the necessary image files. You can also create a boot disk allowing restoration via the network.

**ROM**

Read-Only Memory ROM is a read-only memory in which every memory location can be addressed individually. The programs or data are permanently stored and are not lost in the event of a power failure.

**SCSI interface**

Small Computer System Interface Interface for connecting SCSI devices such as hard disk drives or optical drives.

**Session at once**

In session at once, the CD can be written to both with an audio session and a data session. The two sessions are written to at once (as in disc at once).

**SETUP (BIOS Setup)**

A program in which information about the device configuration (that is the configuration of the hardware on the PC/PG) is defined. The device configuration of the PC/PG is preset with defaults. Changes must therefore be entered in the SETUP if a memory expansion, new modules or a new drive are added to the hardware configuration.

**STEP 7**

Programming software for the creation of user programs for SIMATIC S7 controllers.

**Track-at-once**

In track-at-once recording, a CD can be written to in bits in several sessions if the CD was not closed.

**Troubleshooting**

Error cause, cause analysis, remedy

**V.24 interface**

V.24 is a standardized interface for data transfer. Printers, modems, and other hardware modules can be connected to a V.24 interface.

**Warm restart**

The restart of a computer after a program was aborted. The operating system is loaded and restarted again. The CTRL+ ALT+ DEL hotkey can be used to initiate a warm restart.

## **Windows**

Microsoft Windows is a multitasking graphical user interface. Windows provides a standard graphical interface based on drop-down menus, windowed regions on the screen, and allows operation with a pointer device such as a mouse.

## **WLAN**

**Wireless LAN** is a local network that transmits data via radio waves, infrared light or another wireless technology. Wireless LAN is mainly used for mobile computer applications in office or factory environments.

# Index

## A

- Abbreviations, 117, 122
- Access protection, 26
- Ambient temperature, 52
- Angle brackets
  - Mounting methods, 27
- Antivirus software, 36
- Approvals, 110
- Assignment
  - Resources, 58
- Authorization, 75

## B

- Backup battery
  - Configuration, 69
- Battery, 10
- Battery replacement, 69
- BIOS Setup, 107
- Burner software, 37
- Burning, 37

## C

- Certificates, 110
- Clamp for mains connector, 32
- COM, 96
- Configuration versions, 113
- Connecting
  - Peripherals, 29
- Connection elements, 19

## D

- Data backup, 87
- Degree of protection, 93
- Device configuration, 107
- Device fan, 67
- Disk drives, 15
- Drive bay module, 60
- Drive bay plate, 63

- Dust protection, 93
- DVD burner, 15, 37
- DVD player, 37
- DVD-ROM
  - Installing burner or DVD software, 85
  - Operating notes, 37

## E

- Electrostatic sensitive devices, 10
- EMC, 110
- Enclosure suppliers, 28
- Equipotential bonding, 33
- Error messages, 89
- ESD directives, 10
- ESD guidelines, 115
- Ethernet, 14, 19, 49
- Ethernet address, 24
- Expansion
  - Memory, 15
  - Slots, 14
- Expansion
  - Disk drives, 60
- Expansion module, 59
- Expansion slots, 95

## F

- Factory state, 75
- Fan monitoring, 53
- Fans
  - Connector, 67
  - Screws, 67
- Firewall, 36
- Front cover, 66
- Front door, 66
- Front view, 17

## G

- Graphics, 95
- Guidelines
  - ESD guidelines, 115

## H

Hard disks  
     Partitions, 40  
 Hardware interrupt  
     Assign, 106  
 HDD, 95  
 Hexagonal bolts, 71

## I

Identification data, 24  
 IEC connector, 20  
 Image  
     Creating, 87  
 Initial commissioning, 35  
 Installation  
     Burner / DVD software, 85  
 Installing Windows, 76

## K

Keyboard, 14, 19

## L

Language selection  
     Windows 2000, 80  
     Windows Vista, 84  
     Windows XP Professional, 81  
 Liability disclaimer, 65  
 License Key, 75  
 Lithium battery, 69  
 Localized information, 31  
 LPT1, 96

## M

Main memory, 95  
 Memory expansion, 95  
 Microsoft Windows Product Key, 24  
 Microsoft Windows Product Key, 24  
 Module bracket, 59  
 Modules, 58  
 Monitoring  
     Overview of functions, 15  
     Status displays, 21  
     Watchdog, 15, 52  
 Monitoring software, 53  
 Motherboard, 103  
 Motherboard

Configuration, 71

Mounting  
     Modules, 59  
     Mounting locations, 27  
     Mounting methods, 27  
 Mounting holes, 27  
 Multilanguage User Interface, 80

## O

Online ordering system, 49  
 Open  
     Opening the device, 56  
 Open the front door, 56  
 Opening the device, 56  
 Operating system, 14, 35, 79  
     Initial commissioning, 35  
     Updates, 86  
     Windows Vista, 82  
 Operator controls, 18  
 Order no., 24  
 Output voltage, 97

## P

Partitioning, 77  
 Partitioning the hard disk, 77, 79  
 Partitions  
     Hard disks, 40  
 PCI cards, 58  
 Peripherals, 29  
 Pollutant class, 25  
 Pollution gas, 93  
 Ports  
     Ethernet, 14  
     Keyboard, 14  
     Mouse, 14  
     Parallel, 14, 96  
     PROFIBUS, 19  
     Serial, 14  
     USB, 14, 96  
     VGA, 14  
 Ports  
     Ethernet, 19  
 Power consumption, 93  
 Power requirements, 97  
 Power supply, 14, 20  
 Power supply  
     Connecting, 30  
 Power supply  
     AC supply voltage, 97  
 Power Supply

- Removing the power supply unit, 70
- Power supply unit
  - Configuration, 70
- Processor, 15, 94
- Processor replacement, 72
- Protection class, 25, 93
- PS/2 port, 14

## R

- RAID system
  - Creation, 47
  - Management functions, 42
- RAM expansion, 15
- Rating plate, 24
- Real-time protection, 36
- Rear view, 17
- Recovery
  - Windows Vista, 82
- Recovery functions, 79
- Regional settings, 80
- Removable cartridges, 62
- Removable hard disks
  - Operating notes, 38
- Removal
  - Backup battery, 69
  - Motherboard, 71
  - Power supply unit, 70
- Removing the drive bay module, 61
- Repairs, 9, 65
- Replacing a hard disk, 38
- Replacing filters, 66
- Restart, 35
- Restore DVD, 75
- Retrofitting instructions, 113

## S

- Safety instructions, 9
- Serial number, 24
- Shipping, 23
- Simatic S7, 49
- Slot cover, 59
- Slots, 14
- SOFTNET S7, 49
- Specifications, 93
- Status displays, 21, 96
- Supply voltage, 31, 93
- System partition, 75
- System resources, 103

## T

- Telescopic rails, 98
- Temperature monitoring, 52, 53
- Temperature ranges
  - Approved configuration versions, 113
- Third-party modules, 91
- Troubleshooting/FAQs, 89

## U

- Updates
  - Operating system, 86
  - User programs and drives, 86
- USB, 14

## V

- VGA, 14

## W

- Warranty, 9
- Watchdog
  - Monitoring function, 15
- Watchdog
  - Monitoring function, 52
- Watchdog functions, 15
- Windows Security Center, 36
- Windows Vista
  - Recovery, 82
- Windows XP Professional
  - Language selection, 81

