

- Robust Ø58 mm encoder with hollow shaft
- Short-circuited protected outputs
- IP67 at housing, IP66 at shaft inlet



Technical data

Operating temperature	-40 °C .. +70 °C
Ingress protection class [IEC 60529]	IP67 (IP66 at shaft inlet)
Vibration [IEC 60068-2-6]	≤ 300 m/s ²
Shock [IEC 60068-2-27]	≤ 2000 m/s ²
Cover material	Aluminium
Weight	300 g
Shaft load (axial/radial)	10 N / 20 N
Rotational speed max	6000 rpm
Shaft material	Stainless steel
Short circuit protected	Yes
Polarity protected	No
Current consumption	45 mA (Max. 75 mA)
Output load	± 20 mA
Output frequency max	300 kHz
Cable length max	50 m at 50 kHz
Channel separation	90° el ± 25° el
Dividing error	±50° el

Encoder configuration

Type	RHI
Model	503 Standard
Shaft type	Ø12 mm through-going hollow shaft
Flange type	58/59-flange with stator coupling
Resolution	1000
Power supply	5 Vdc
Output signal	TTL
Connection type	M23 connector 12-pin
Connecting direction	Radial

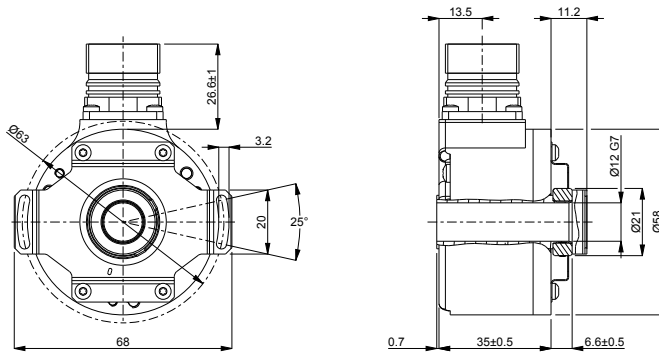
Dimensions**Output signals****Pin configuration**

Function	Pin
S90 inverted	1
Not used	2
Sref	3
Sref inverted	4
S00	5
S00 inverted	6
Status	7
S90	8
Not used	9
0V	10
Not used	11
+EV	12

Ordering information

Part number

519368-01