

- Robust Ø58 mm encoder with hollow shaft
- Short-circuited protected outputs
- IP67 at housing, IP66 at shaft inlet



Technical data

| | |
|--------------------------------------|------------------------------|
| Operating temperature | -40 °C .. +70 °C |
| Ingress protection class [IEC 60529] | IP67 (IP66 at shaft inlet) |
| Vibration [IEC 60068-2-6] | ≤ 300 m/s ² |
| Shock [IEC 60068-2-27] | ≤ 2000 m/s ² |
| Cover material | Aluminium |
| Weight | 300 g |
| Shaft load (axial/radial) | 10 N / 20 N |
| Rotational speed max | 6000 rpm |
| Shaft material | Stainless steel |
| Short circuit protected | Yes |
| Polarity protected | Yes |
| Current consumption | 50 mA at 24 Vdc (Max. 75 mA) |
| Output load | ± 40 mA |
| Output frequency max | 300 kHz |
| Cable length max | 100 m at 100 kHz |
| Channel separation | 90° el ± 25° el |
| Dividing error | ±50° el |

Encoder configuration

| | |
|----------------------|-----------------------------------|
| Type | RHI |
| Model | 503 Standard |
| Shaft type | Ø12 mm through-going hollow shaft |
| Flange type | 58/59-flange with stator coupling |
| Resolution | 300 |
| Power supply | 9-30 Vdc |
| Output signal | HTL |
| Connection type | M23 connector 12-pin |
| Connecting direction | Radial |

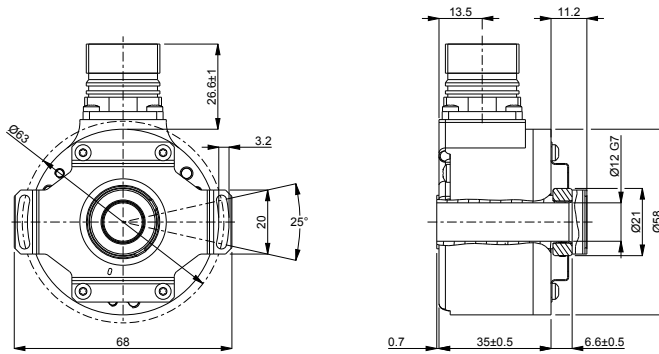
Dimensions**Output signals****Pin configuration**

| Function | Pin |
|---------------|-----|
| S90 inverted | 1 |
| Not used | 2 |
| Sref | 3 |
| Sref inverted | 4 |
| S00 | 5 |
| S00 inverted | 6 |
| Status | 7 |
| S90 | 8 |
| Not used | 9 |
| 0V | 10 |
| Not used | 11 |
| +EV | 12 |

Ordering information

Part number

519858-05