

- Robust Ø58 mm encoder with hollow shaft
- Short-circuited protected outputs
- IP67 at housing, IP66 at shaft inlet



## Technical data

Operating temperature	-40 °C .. +70 °C
Ingress protection class [IEC 60529]	IP67 (IP66 at shaft inlet)
Vibration [IEC 60068-2-6]	≤ 300 m/s <sup>2</sup>
Shock [IEC 60068-2-27]	≤ 2000 m/s <sup>2</sup>
Cover material	Aluminium
Weight	300 g
Shaft load (axial/radial)	10 N / 20 N
Rotational speed max	6000 rpm
Shaft material	Stainless steel
Short circuit protected	Yes
Polarity protected	Yes
Current consumption	50 mA at 24 Vdc (Max. 75 mA)
Output load	± 40 mA
Output frequency max	300 kHz
Cable length max	100 m at 100 kHz
Channel separation	90° el ± 25° el
Dividing error	±50° el

## Encoder configuration

Type	RHI
Model	503 Standard
Shaft type	Ø12 mm through-going hollow shaft
Flange type	56/57-flange
Resolution	64
Power supply	9-30 Vdc
Output signal	HTL
Connection type	M23 connector 12-pin
Connecting direction	Radial

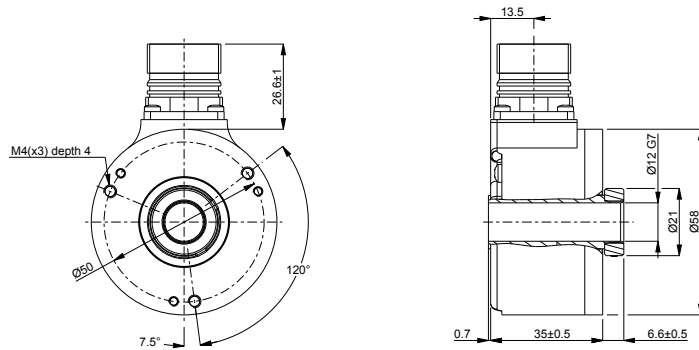
**Dimensions****Output signals****Pin configuration**

Function	Pin
S90 inverted	1
Not used	2
Sref	3
Sref inverted	4
S00	5
S00 inverted	6
Status	7
S90	8
Not used	9
0V	10
Not used	11
+EV	12

**Ordering information**

Part number

521009-16