

**HRTR 55 "XL"**

**Diffuse reflection light scanner with background suppression**

en 05-2013/03 50107829-02



**Dimensioned drawing**

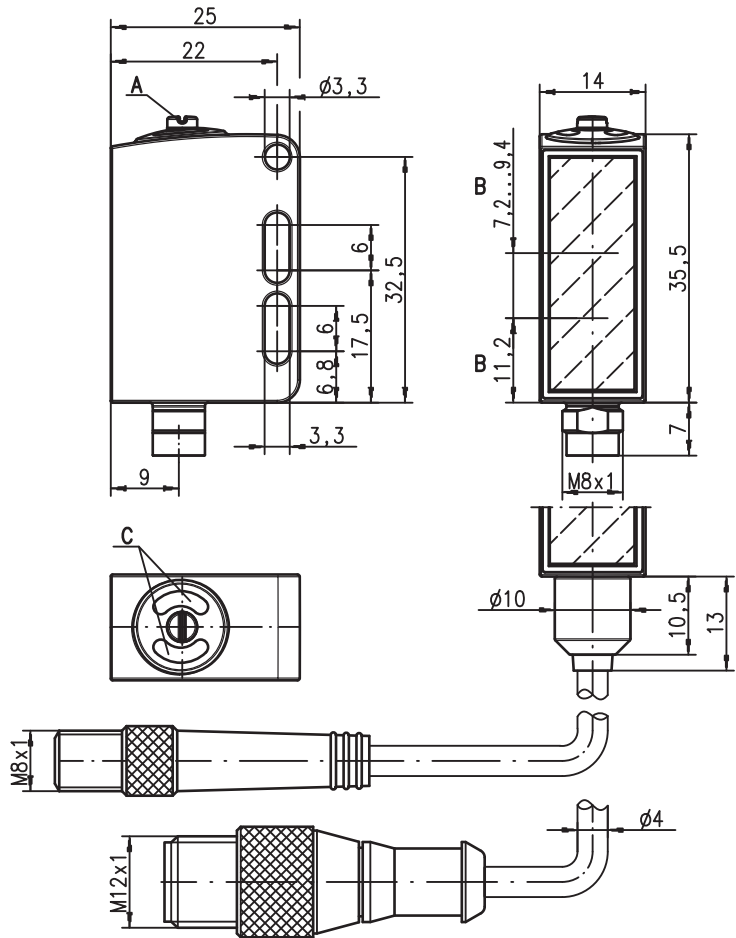

- A** Adjustment screw
- B** Optical axis
- C** Indicator diode

**5 ... 100mm**  
60mm with  
black-white error < 10%



- Diffuse reflection light scanner with visible red light and adjustable background suppression
- 316L stainless steel housing in Hygiene-Design
- Enclosed optics design prevents bacterial carry-overs
- ECOLAB and CleanProof+ tested
- Paperless device identification
- Scratch resistant and non-diffusive plastic front cover
- Wide, rectangular light spot guarantees the reliable detection of:
  - objects with openings, holes and grooves
  - transparent foils and bottles
  - objects with grid structures (e.g. blister packs)
  - objects with variable position
- A²LS- Active Ambient Light Suppression
- Push-pull switching outputs
- High switching frequency for detection of fast events

**Electrical connection**

Plug connection, 4-pin (with/without cable)

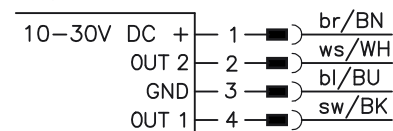

Plug connection, 3-pin

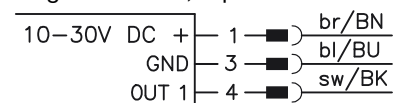

**Accessories:**

(available separately)

- Cable with M8 or M12 connector (K-D ...)
- Cable for food and beverages
- Mounting devices

We reserve the right to make changes • DS\_HRTR55XL\_en\_50107829-02.fm

**Specifications**

**Optical data**

Typ. scanning range limit <sup>1)</sup> 5 ... 100mm  
 Scanning range <sup>2)</sup> see tables  
 Adjustment range 20 ... 100mm  
 Light spot approx. 3 x 40mm<sup>2</sup> at 50mm  
 Light source <sup>3)</sup> LED (modulated light)  
 Wavelength 620nm (visible red light)

**Timing**

Switching frequency 1000Hz  
 Response time 0.5ms  
 Delay before start-up ≤ 300ms (acc. to. IEC 60947-5-2)

**Electrical data**

Operating voltage U<sub>B</sub> <sup>4)</sup> 10 ... 30VDC (incl. residual ripple)  
 Residual ripple ≤ 15% of U<sub>B</sub>  
 Open-circuit current ≤ 15mA  
 Switching output .../66 <sup>5)</sup> 2 push-pull switching outputs  
 pin 2: PNP dark switching, NPN light switching  
 pin 4: PNP light switching, NPN dark switching  
 .../22 2 NPN switching outputs, complementary  
 .../44 2 PNP switching outputs, complementary  
 .../6 <sup>5)</sup> 1 push-pull switching output  
 pin 4: PNP light switching, NPN dark switching  
 light/dark switching  
 Function characteristics ≥ (U<sub>B</sub> - 2V) / ≤ 2V  
 Signal voltage high/low max. 100mA  
 Output current adjustable via 8-turn potentiometer  
 Scanning range

**Indicators**

Green LED ready  
 Yellow LED object detected - reflection

**Mechanical data**

Housing AISI 316L stainless steel, DIN X2CrNiMo17132, W.No1.4404  
 Housing design WASH-DOWN-Design  
 Housing roughness <sup>6)</sup> Ra ≤ 2.5  
 Connector AISI 316L stainless steel, DIN X2CrNiMo17132, W.No1.4404  
 Optics cover coated plastic (PMMA), scratch resistant and non-diffusive  
 Operation plastic (TPV - PE), non-diffusive  
 Weight with M8 connector: 40g  
 with 200mm cable and M12 connector: 60g  
 with 5000mm cable: 110g  
 Connection type M8 connector, 4-pin,  
 0.2m cable with M12 connector, 4-pin,  
 5m cable, 4 x 0.20mm<sup>2</sup>

**Environmental data**

Ambient temp. (operation/storage) <sup>7)</sup> -30°C ... +70°C / -30°C ... +70°C  
 Protective circuit <sup>8)</sup> 2, 3  
 VDE safety class <sup>9)</sup> III  
 Protection class IP 67, IP 69K <sup>10)</sup>  
 Environmentally tested acc. to ECOLAB, CleanProof+  
 LED class 1 (acc. to EN 60825-1)  
 Standards applied IEC 60947-5-2  
 Certifications UL 508 <sup>4)</sup>  
 Chemical resistance tested in accordance with ECOLAB and CleanProof+  
 (see remarks)

- 1) Typ. scan. range limit: max. achievable scanning range for light objects (white 90%)
- 2) Scanning range: recommended scanning range for objects with different diffuse reflection
- 3) Average life expectancy 100,000h at an ambient temperature of 25°C
- 4) For UL applications: for use in class 2 circuits according to NEC only
- 5) The push-pull switching outputs must not be connected in parallel
- 6) Typical value for the stainless steel housing
- 7) Operating temperatures of +70°C permissible only briefly (≤ 15min)
- 8) 2=polarity reversal protection, 3=short-circuit protection for all transistor outputs
- 9) Rating voltage 50V
- 10) Only in combination with M12 connector

**Approved purpose**

The light scanners are optical electronic sensors for optical, contactless detection of objects. This product may only be used by qualified personnel and must only be used for the approved purpose. This sensor is not a safety sensor and is not to be used for the protection of persons.

**Tables**

1	5	100
2	5	90
3	5	80

1	white 90%
2	gray 18%
3	black 6%

Scanning range [mm]  
 Typ. scanning range limit [mm]

**Diagrams**

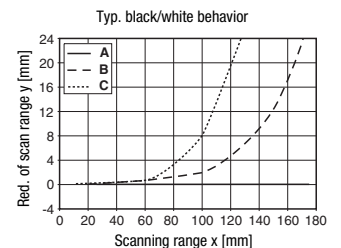
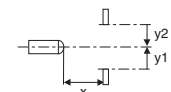
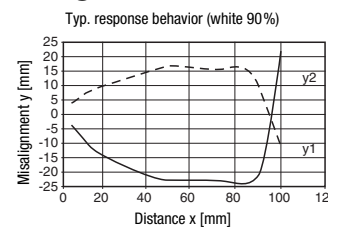

- A white 90%
- B gray 18%
- C black 6%

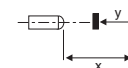

**Remarks**

A list of tested chemicals can be found in the first part of the product description.

## HRTR 55 "XL"

## Diffuse reflection light scanner with background suppression

### Order guide

Selection table		Order code →						
Equipment ↓		HRTR 55/44-XL-5000 Part No. 50116828	HRTR 55/22-XL-5000 Part No. 50117199	HRTR 55/66-XL-5000 Part No. 50114070	HRTR 55/66-XL-S8 Part No. 50107496	HRTR 55/6-XL-S8.3 Part No. 50107497	HRTR 55/66-XL-200-S12 Part No. 50107498	
Switching output	2 x PNP output, complementary	●						
	2 x NPN output, complementary		●					
	2 x Push-pull switching output			●	●		●	
	1 x Push-pull switching output					●		
Switching function	1 PNP light switching and NPN dark switching output			●	●	●	●	
	1 PNP dark switching and NPN light switching output			●	●		●	
Connection	M8 connector, metal, 4-pin				●			
	M8 connector, metal, 3-pin					●		
	200mm cable with M12 connector, 4-pin						●	
	5000mm cable, 4-pin	●	●	●				
Indicators	Green LED: ready	●	●	●	●	●	●	
	Gellow LED: switching output	●	●	●	●	●	●	

### Application notes



- For glossy surfaces (e.g. metals), the light beam should not be incident on the object surface at a right angle. A slight inclination is sufficient for preventing undesired direct reflections. This may result in a reduction in the scanning range.
- Objects should only be moved laterally from the right or left. Moving in objects from the connector side or operating side is to be avoided.
- Outside of the scanning range, the sensor operates as an energetic diffuse reflection light scanner. Light objects can still be reliably detected up to the scanning range limit.
- The sensors are equipped with effective measures for the maximum avoidance of mutual interference should they be mounted opposite one another. Opposite mounting of multiple sensors of the same type should, however, absolutely be avoided.

