

(I)GS 63

Forked photoelectric sensor

en 07-2013/08 50111254



3mm



- Optical forked photoelectric sensor with 3mm fork width and 60mm fork depth for exact detection of labels on base material
- High switching frequency and short response time guarantee very good repeatability
- **NEW** – Slim-line design (reduced fork height) for installation directly on the dispensing edge
- **NEW** – ALC function (Auto Level Control): highest performance reserve through autonomous online optimization of the switching threshold ((I)GS63/...3...)
- **NEW** – Storage of up to 30 teach values in the sensor
- **NEW** – Warning output for indicating teach or function errors (IGS63...)
- **NEW** – Easy adjustment via lockable teach button or teach input



Accessories:

(available separately)

- Mounting device BT-GS6X (Part No. 50110803)
- Mounting device BT-GS6X.L (Part No. 50112215)
- Mounting device BT-GS6X.H (Part No. 50123869)

Dimensioned drawing

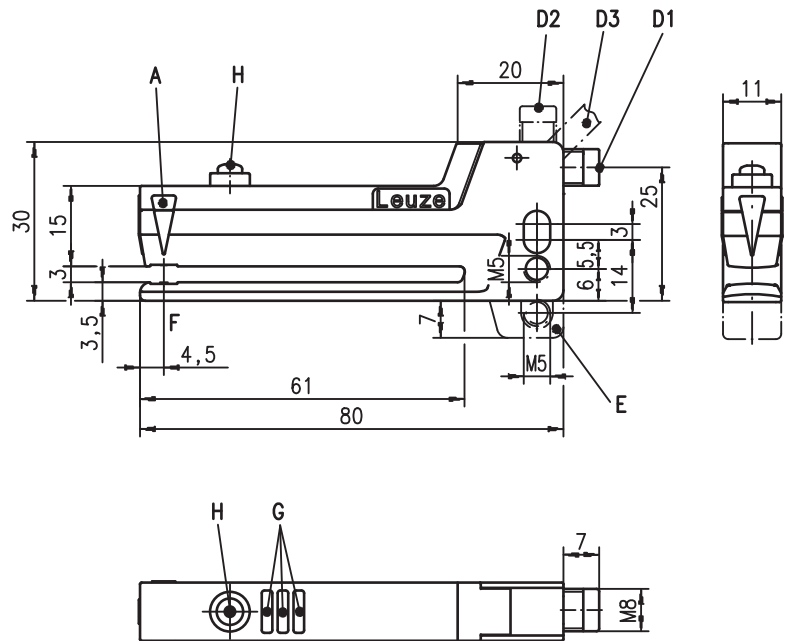

- A** Label center position
- D** D1: horizontal connector, D2: vertical connector, D3: cable
- E** Mounting device BT-GS6X; BT-GS6X.L
- F** Optical axis
- G** Indicator diodes
- H** Teach button

Electrical connection

Connector, 4-pin

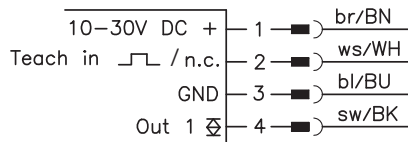

Connector, 5-pin

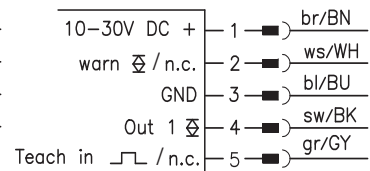

Cable, 5-wire, IGS 63 only

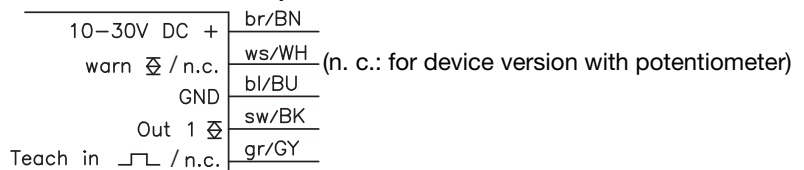

We reserve the right to make changes • DS_IGS63_en_50111254.fm

Specifications

Physical data

Mouth width	3mm
Mouth depth	60mm
Label width	≥ 2mm
Label gap	≥ 2mm
Light source	940nm (infrared light)
Switching frequency	max. 10kHz
Conveyor speed with teach-in	≤ 20m/min (0.3m/s)
Typ. response time	≤ 50µs
Repeatability	see diagrams
Delay before start-up	≤ 300ms acc. to IEC 60947-5-2

Electrical data

Operating voltage U_B	10 ... 30VDC (incl. residual ripple)
Residual ripple	≤ 15% of U_B
Open-circuit current	≤ 30mA
Switching output 1)	1 push-pull switching output
switching signal in the label gap	pin 4: PNP gap signal, NPN label signal
.../6D	1 push-pull switching output
signal on the label	pin 4: PNP label signal, NPN gap signal
Warning output IGS 63 only...	1 push-pull switching output
	pin 4: active low (normal operation high, event case low)
Switching output function	gap signal/label signal adjustable
Signal voltage high/low	≥ ($U_B - 2V$) / ≤ 2V
Output current	≤ 100mA
Capacitive load	≤ 0.2µF ²⁾

Indicators

Green LED	ready
Yellow LED	switching signal in the label gap
Red LED	teaching error / function error

Mechanical data

Housing base	diecast zinc; cathodic immersion lacquered surface, black RAL 9005
Upper part of housing	PC plastic, red RAL 3000
Optics	PC plastic
Weight	55g with connector, 100g with cable
Connection type	M8 connector, 4-pin, metal or cable 2m (cross section 5 x 0.2mm ²)

Environmental data

Ambient temp. (operation/storage)	-20°C ... +60°C / -30°C ... +70°C
Protective circuit ³⁾	1, 2
VDE safety class	III
Protection class	IP 65 with mounted connector
Standards applied	IEC 60947-5-2
Certifications	UL 508 ⁴⁾

Options

Teach-in input	
Active/Not active	≥ 8V / ≤ 2V
Activation/disable delay	≤ 0.2ms
Input resistance	typ. 10kΩ

- 1) The push-pull switching outputs must not be connected in parallel
- 2) Max. permissible input capacitance of a consumer connected to the switching output that can be switched without activation of short-circuit-current limiting.
- 3) 1=polarity reversal protection, 2=short circuit protection for all outputs
- 4) For UL applications: for use in class 2 circuits according to NEC only

Marking on the sensor

- Align the label tape according to the sensor's marker "Label center position".

Diagrams

Repeatability as a function of the conveyor speed

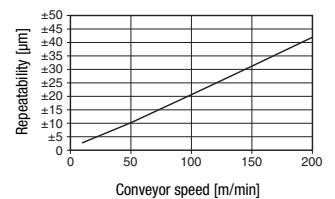

Remarks

Approved purpose:

The forked photoelectric sensor is an optoelectronic sensor for contactless detection of non-transparent labels on any given base material. Depending on the setting, a switching signal occurs in the gap (gap signal) between two successive labels or on the label (label signal).

This product may only be used by qualified personnel and must only be used for the approved purpose. This sensor is not a safety sensor and is not to be used for the protection of persons.

Order guide

The sensors listed here are preferred types; current information at www.leuze.com.

	Designation	Part no.
Without warning output	GS63/6.3-S8	50110104
	GS63/6D.3-S8	50110105
	GS63/6.3-S8V	50110106
	GS63/6D.3-S8V	50110107
With warning output	IGS63/6.3	50110759
	IGS63/6D.3	50110760
Potentiometer	GS63/6	501 12615
	GS63/6,200-S12	501 12616
	GS63/6-S8	501 12617
	GS63/6-S8V	501 12618
	GS63/6D	501 12619
	GS63/6D-S8	501 12620

Part number code

I	G	S	6	3	/	6	D	.	3	-	S	8	V
---	---	---	---	---	---	---	---	---	---	---	---	---	---

Warning function	
I	Sensor has warning output
Operating principle	
GS	Forked sensor, optical
Series	
63	High quality series with metal housing
Output function	
/6	Push-pull output: PNP signal in the label gap, NPN signal on the label
/6D	Push-pull output: PNP signal on the label, NPN signal in the label gap
Configuration	
N/A	Potentiometer adjustment
.3	Teach button on the device and teach input
Electrical connection	
N/A	Device with cable, standard length 2000mm, cable outlet at 45°
-S8	M8 connector, 4-pin, horizontal plug outlet
-S8V	M8 connector, 4-pin, vertical plug outlet
,200-S12	200mm cable with M12 connector, 5-pin, cable outlet at 45°

ALC (Auto Level Control) function ((I)GS63/....3...)

In each teach event the current signal values in the sensor are digitally determined, resulting in the optimum switching threshold being calculated for maximum performance reserve. All values are saved permanently, retaining their validity as long as the dynamic parameters of the system remain unchanged and the material is not changed.

Signal changes can result each time the roll is changed, even with labels that are apparently the same. This is caused, for example, by material variations (transmission factor, homogeneity ...) or changes of the dynamic parameters (e.g. tape tension, middle position, jitter, etc.) that can have a negative affect on the performance reserve of the sensor.

With the ALC function, the sensor now automatically corrects the switching threshold in such a way that the maximum performance reserve is always available during operation - the sensor works absolutely reliably and free of errors.

The teach event only needs to be repeated if the sensor does not switch following a change of material.

Sensor adjustment via potentiometer for (I)GS 63

Notice: A removable operating button is plugged on the potentiometer in ex works. This can be used to manually adjust the forked photoelectric sensor without the use of a tool. If this is not desired, the operating button can be pulled off – a screwdriver is then necessary for making adjustments.

The following description applies to a forked photoelectric sensor with switching signal in the label gap ((I)GS 63/6...). For device versions with switching signal on the label ((I)GS 63/6D...), the LED indicators are inverted.

Preparation: Remove one or more labels from the base material and advance this blank area into the sensor.

- If the yellow OUT LED does not switch on when the blank area is encountered, increase the sensitivity by turning the potentiometer clockwise until the yellow OUT LED switches on.
- Starting from this setting, turn the potentiometer clockwise another approx. one half turn.
- Now advance the label tape so that a label is in the sensor.
- If set correctly, the yellow OUT LED must now switch off. Reduce the sensitivity by turning counterclockwise if the LED remains on.
- Finished: if set correctly, the LED changes between gap and label.

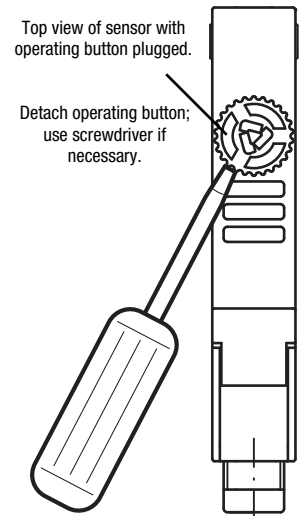

Short instructions for sensor adjustment via teach button for (I)GS 63 (teach-in)

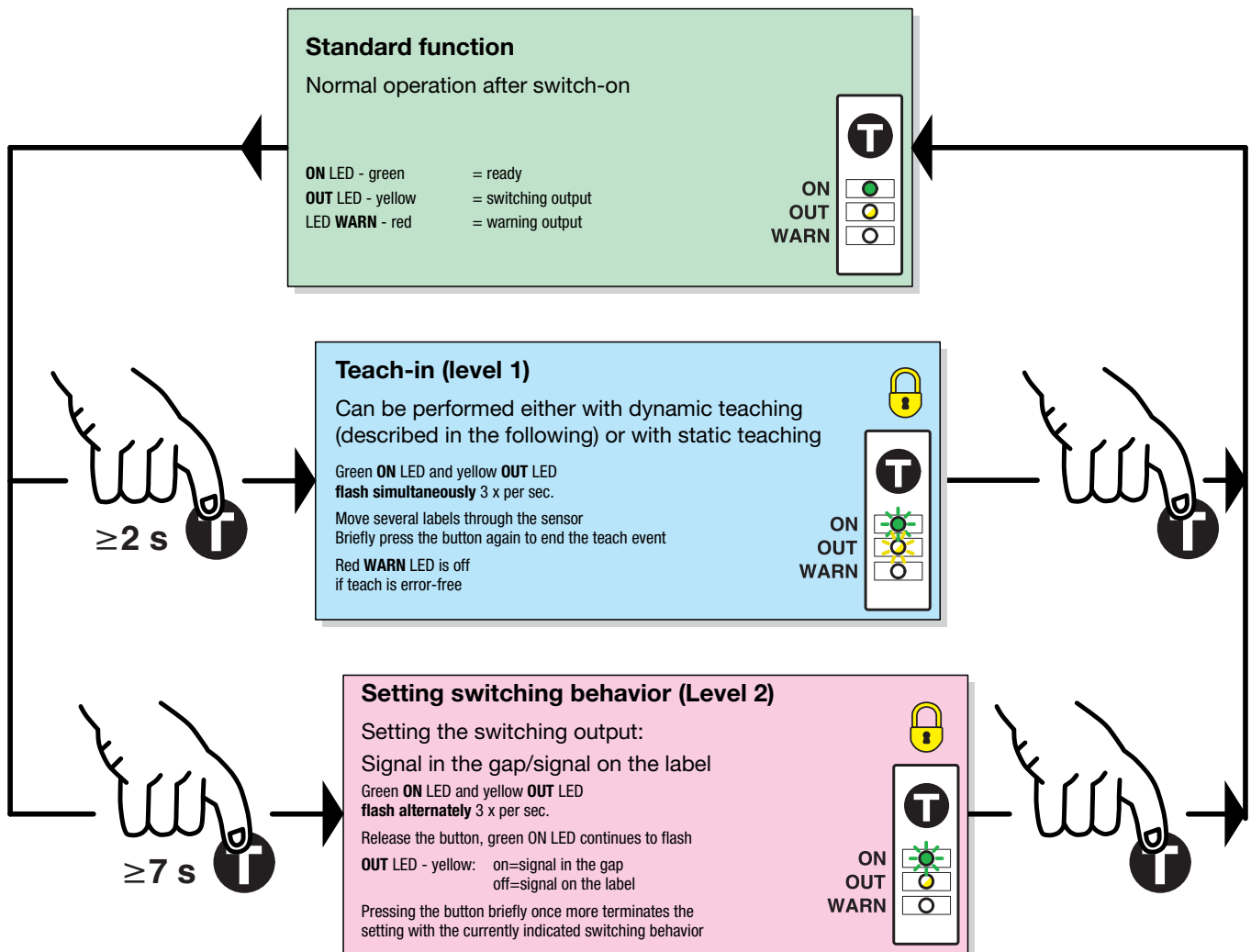

= function lockable through constant application of U_B on the teach input (for devices with teach input only)

(I)GS 63

Forked photoelectric sensor

Standard function for (I)GS 63

During operation the sensor is always in this function. The sensor detects label gaps with high precision and speed. This is indicated by the yellow LED and the switching output.

Indicators:

ON LED - green	Constantly ON when operating voltage is applied.
OUT LED - yellow	Indicates the switching signal. LED is ON if the sensor detects label gaps. The display is independent of the output setting.
WARN LED - red	Is OFF if operation is error-free. If the "Control limit reached" message appears or if the last teach event was faulty, the red LED illuminates.

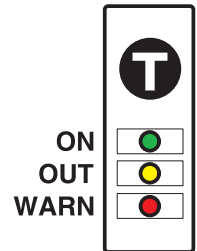

Operation

The teach button must be pressed for at least 2 seconds to operate the device. The button can be electrically disabled to prevent accidental operation.

Sensor adjustment (teach-in) via teach button for (I)GS 63

Manual teach while label tape is passing through (dynamic)

Preparation: Insert label tape into the sensor.

- Press the teach button until green and yellow LEDs flash simultaneously.
- Release teach button.
- During the teach event, the switching output is frozen in the most recently valid state prior to teaching.
- Advance the label tape at a maximum speed of 20m/min through the sensor so that at least 3 ... 7 labels pass through the sensor.
- Press the button briefly once more to terminate the teach event, the sensor goes into standard mode.

3 ... 7 label gaps should be advanced through the sensor in order to achieve stable switching points.

If the teach event is faulty (e.g. transmission with insufficiently thick base material), the red LED illuminates, the green and yellow LEDs flash rapidly and the warning output is activated. For error acknowledgment, briefly press the teach button and repeat the teach event. If the error cannot be rectified, the label material cannot be detected with the (I)GS 63.

Manual teach if the label tape cannot be advanced (static)

Preparation: Remove one or more labels from the base material and advance this blank area into the sensor.

- Press the teach button until green and yellow LEDs flash simultaneously.
- Release teach button.
- During the teach event, the switching output is frozen in the most recently valid state prior to teaching.
- Press the button briefly once more to terminate the teach event, the sensor goes into standard mode.

If the teach event is faulty (e.g. transmission with insufficiently thick base material), the red LED illuminates, the green and yellow LEDs flash rapidly and the warning output is activated. For error acknowledgment, briefly press the teach button and repeat the teach event. If the error cannot be rectified, the label material cannot be detected with the (I)GS 63.

Adjusting the switching behavior of the switching output (signal in the label gap/on the label)

- Press the teach button until green and yellow LEDs flash alternately.
- Release the teach button - the green LED continues to flash, the yellow LED alternates slowly between ON and OFF.
- Yellow LED ON = output switches in the label gap
Yellow LED OFF = output switches on the label.
- If the button is pressed again while the LED is ON, the device switches in the label gap. For control purposes, the switching behavior is displayed as long as the button is pressed. If the output is to switch on the label, the button must be pressed while the LED is OFF.
- Ready.

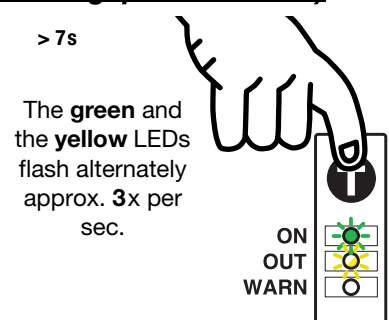
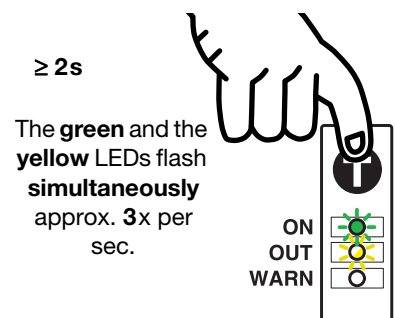
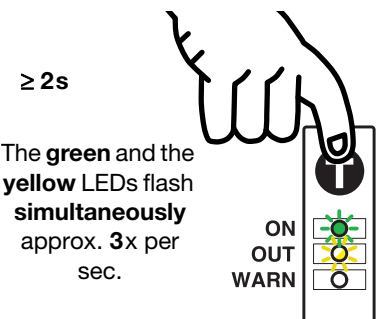

Sensor adjustment (teach-in) via teach input for (I)GS 63



The following description applies to PNP switching logic!

U_{Teach}	not connected	Internal pull-down resistor pulls the input down to zero	Teach button can be operated; all functions adjustable
$U_{Teach\ low}$	$\leq 2V$	Low level	Teach button can be operated; all functions adjustable
$U_{Teach\ high}$	$\geq 8V$	High level	Teach button disabled; button has no function
U_{Teach}	$> 2V \dots < 8V$	Not permitted	

The device setting is stored in a fail-safe way. A reconfiguration following voltage interruption or switch-off is thus not required.

Line teach while label tape is passing through

Preparation: Insert the label tape in the correct position in the sensor (align the middle of the tape to the sensor marking).

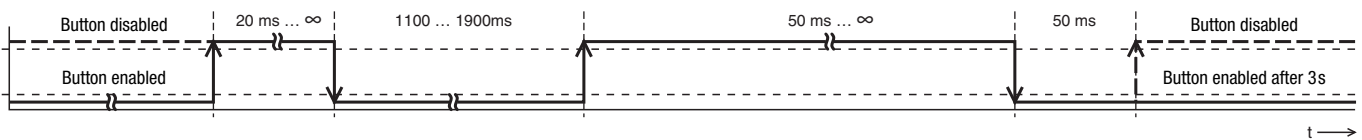

	Pulse only necessary if a low-level was applied previously	Activation of the teach-in: Action starts with the falling edge: $t_{Teach} = 1100 \dots 1900ms$	The rising edge starts the teach event. The green and yellow LEDs flash alternately 3x per second as long as the signal is high. Advance the label tape so that several label gaps pass the sensor, thereby allowing the teach values to be determined.	The teach event is concluded with the falling edge. 50 ms after the falling edge, the sensor returns to normal operation. The teach button is enabled again after max. 3s.
--	--	--	--	--

The red LED illuminates and the warning output is activated if a teaching error occurs (e.g. the label cannot be reliably detected due to insufficient signals).

Regardless of the state, the green LED is on when the teach event is terminated, the yellow LED indicates the current switching state.

Line teach if the label tape cannot be advanced (static teaching)

Preparation: Remove one or more labels from the base material and place this blank area in the sensor. The label tape must now not be advanced further.

The process is identical to the line teach with moving label tape.

Adjusting the switching behavior of the switching output – light/dark switching

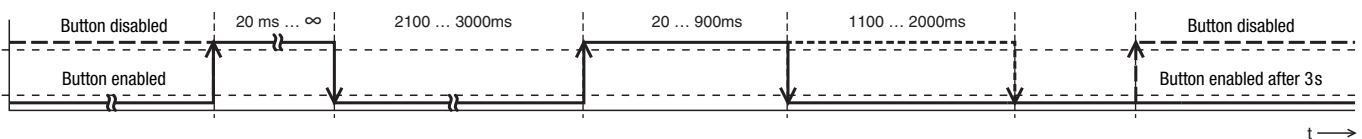

	Pulse only necessary if a low-level was applied previously	Activation of the teach switching output: Action starts with the falling edge: $t_{Teach} = 2100 \dots 3000ms$	Switching output switches in the label gap (20 ... 900ms) Switching output switches on the label (1100 ... 2000ms)	The teach event is concluded with the falling edge. 50 ms after the falling edge, the sensor returns to normal operation. The teach button is enabled again after max. 3s.
--	--	--	---	--

(I)GS 63

Forked photoelectric sensor

Storing teach values in the sensor

It is possible to store or retrieve up to 30 different teach values. In this way, various label materials can be processed without the operator needing to perform a teach event. If this function is desired, static interlocking of the teach button is recommended so that no operation of the device can occur.

The event starts with the execution of the line teach (see description on page 6). The teach value ascertained in this way remains in sensor memory and is then stored in one of 30 possible storage places using the process described in the following.

Flow chart: First perform line teach, then store teach value.

Storing teach values

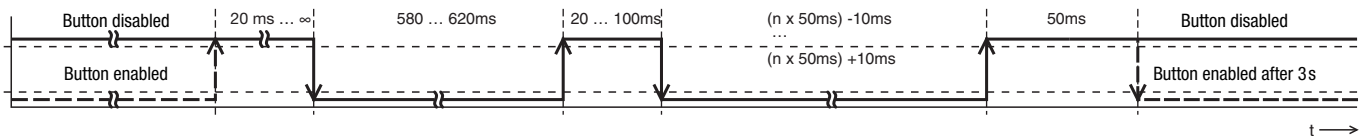

	Pulse only necessary if a low-level was applied previously	Activation - store current teach value: Action starts with the falling edge: $t_{Teach} = 580 \dots 620 \text{ ms}$		Select storage place: The pulse length determines the storage place for the current teach value: $n=1,2,3 \dots 30$ Example: t for storage place 3: 140ms ... 160ms	The selection of the storage place is concluded with the rising edge. 50 ms after the rising edge, the sensor returns to normal operation.	
--	--	---	--	---	--	--

Reading out teach values

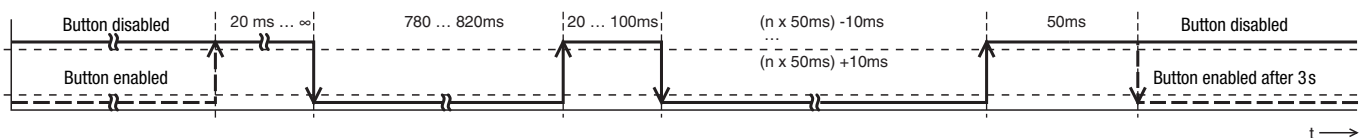

	Pulse only necessary if a low-level was applied previously	Action - read out teach value: Action starts with the falling edge: $t_{Teach} = 780 \dots 820 \text{ ms}$	Load teach value	Select storage place: The pulse length determines the storage place from which the teach value is loaded: $n=1,2,3 \dots 30$ Example: t for storage place 7: 340ms ... 360ms	The selection of the storage place is concluded with the rising edge. 50 ms after the rising edge, the sensor returns to normal operation.	
--	--	--	------------------	--	--	--

Locking the teach button via the teach input



(I)GS 63

A **static high signal** on the teach input locks the teach button on the device so that no manual operation is possible (e.g. protection against erroneous operation or manipulation).

If the teach input is not connected or if there is a static low signal, the button is enabled and can be operated freely.

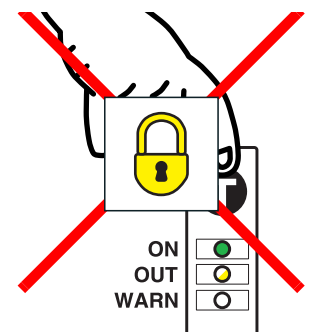

Notices for integrating the sensor in a control concept

If the sensor is taught externally via a control, it may be necessary to receive acknowledgment from the sensor with respect to its current teach state. Use the following chart for this purpose:

Operating mode	Reaction from sensor
Dispensing mode	Dynamic output signal: alternates between gap and label
Teach	Static output signal: the state prior to teaching is frozen
Teach OK	Output signal is dynamic again—warning output not active
Teach faulty	Output signal is dynamic again—warning output active; repeat teach event if necessary

Mounting with mounting device BT-GS6X or BT-GS6X.L

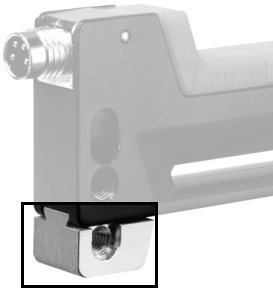

The BT-GS6X or BT-GS6X.L are necessary if mounting compatibility with the GS 06 forked photoelectric sensor is desired. When using, ensure secure seating (tighten set screw).

Maintenance information

The (I)GS 63 forked photoelectric sensor is largely maintenance free. Depending on the environmental conditions and the used materials, it may be necessary from time to time to clean the transparent parts in the lower and upper fork of the forked photoelectric sensor. We recommend using a soft, moist cloth for this purpose. To protect the surface, cleaning agents containing solvents should not be used for transparent parts.

Environmental durability

The used materials feature very good resistance to weak acids and bases as well as to UV exposure. Contact with organic solvents is possible only to a limited extent and only for short times. Resistance to chemicals and oils must be determined on a case-by-case basis.