

KRTW 3B

White light contrast scanner

en 05-2011/04 50110626-02



Dimensioned drawing

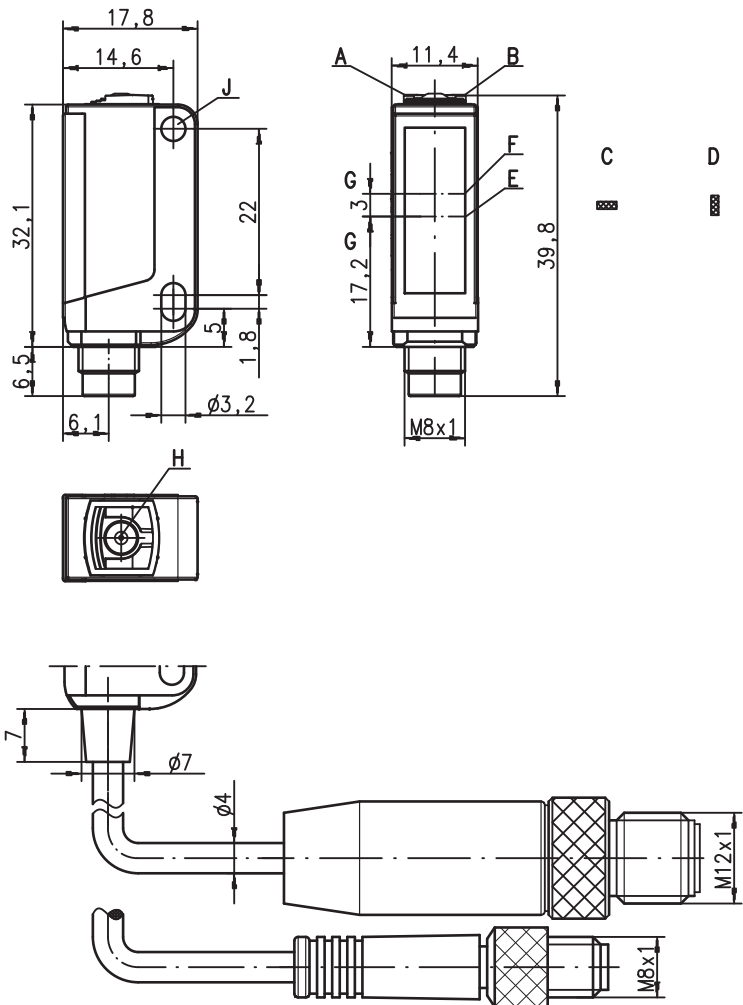

- A Green indicator diode
- B Yellow indicator diode
- C Light spot orientation horizontal
- D Light spot orientation vertical
- E Transmitter
- F Receiver
- G Optical axis
- H Teach button
- J Attachment sleeve

14.5mm

10 kHz

10 - 30 V
DC

IO-Link

- White light transmitter
- Various teach variants
- Short response time
- Switching threshold adjustment via EasyTune
- Level adaptation for glossy objects
- Keyboard lockout
- Remote teach via cable
- Pulse stretching 20ms

Electrical connection

Plug connection, 4-pin

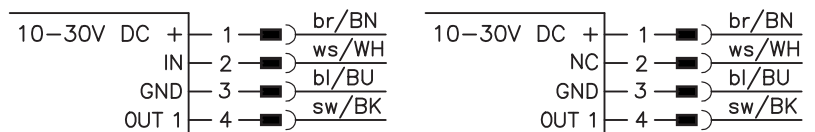

Accessories:

(available separately)

- Mounting systems (BT 3...)
- Cable with M8 or M12 connector (K-D ...)

We reserve the right to make changes • DS_KRTW3B_en.fm

Specifications

Optical data

	KRTW 3B/...10-S8	KRTW 3B/...21-S8
Scanning range ¹⁾	14.5mm ± 2mm	
Light spot dimensions	1.5mm x 4mm (at a distance of 14.5mm)	
Light spot orientation	vertical or horizontal (see dimensioned drawing)	
Light source ²⁾	white LED (optimized through YellowBoost)	
Wavelength	430 ... 700nm	

Sensor operating modes

IO-Link	COM2 (38.4kBaud)
SIO	standard push-pull
Dual Core	no

Timing of the sensor

Internal switching frequency	6kHz	10kHz
Internal response time	83µs	50µs
Response jitter, internal	20µs	20µs
Repeatability ³⁾	0.02mm	0.02mm
Delay before start-up	≤ 300ms	
Conveyor speed during teach	≤ 0.1 m/s for a mark width of 1 mm	
Teach process	static 1-point, static 2-point or dynamic 2-point	
Teach delay	≤ 10ms	

Timing of the outputs

Response time	Pin 4	IO-Link COM2: acc. to IO-Link specification (typically 2.5ms)
		SIO: 50µs

Electrical data

Operating voltage U_B ⁴⁾	with SIO	10 ... 30VDC (incl. residual ripple)
	with COM2	18 ... 30VDC (incl. residual ripple)
Residual ripple		≤ 15% of U_B
Output/function	.../2...	pin 4: GND if mark detected
	.../4...	pin 4: U_B if mark detected
	.../6...	pin 4: IO-Link SIO mode, U_B if mark detected
	.../6...	pin 4: IO-Link COM2 mode, see configuration file IODD
Signal voltage high/low		≥ ($U_B - 2V$) / ≤ 2V
Output current		max. 100mA
Open-circuit current		≤ 20mA

Indicators

Green LED in continuous light	ready
Green and yellow LED flashing at 3Hz	teach event active
Green and yellow LED flashing at 8Hz	teaching error
Green LED off and yellow LED flashing at 8Hz	sensor error
Yellow LED in continuous light	mark detected (dependent on the teach sequence)
Transmitter LED, white flashing at 8Hz	teaching error

Mechanical data

Housing ⁵⁾	plastic (PC-ABS), with/without attachment sleeve, nickel-plated steel
Optics cover	plastic (PMMA)
Weight	with M8 metal plug: 10g with M8 plastic plug: 8g
Connection type	M8 connector, metal or plastic

Environmental data

Ambient temp. (operation/storage)	-30°C ... +55°C / -30°C ... +70°C
Protective circuit ⁶⁾	2, 3
VDE safety class	III
Protection class	IP 67
Light source	free group (in accordance with EN 62471)
Standards applied	IEC 60947-5-2
Certifications	UL 508 ⁴⁾

Options

Input pin 2	
Function characteristics	keyboard lockout / line teach / pulse stretching
Input active/not active	≥ 8V / ≤ 2V or not connected
Output pin 4	
Line teach active	for SIO 2Hz at the switching output
	for COM2 see configuration file IODD
Error after line teach	for SIO 2Hz at the switching output
	for COM2 see configuration file IODD

- 1) Scanning range: recommended range with performance reserve
- 2) Average life expectancy 100,000h at an ambient temperature of 25°C
- 3) At conveyor speed 1 m/s
- 4) For UL applications: for use in class 2 circuits according to NEC only
- 5) Patent Pending Publ. No. US 7,476,848 B2
- 6) 2=polarity reversal protection, 3=short-circuit protection for all transistor outputs

Tables

Diagrams

Remarks

- **Approved purpose:**
This product may only be used by qualified personnel and must only be used for the approved purpose. This sensor is not a safety sensor and is not to be used for the protection of persons.
- With glossy objects, the sensor is to be fastened at an inclination of approx. 10° relative to the object surface.

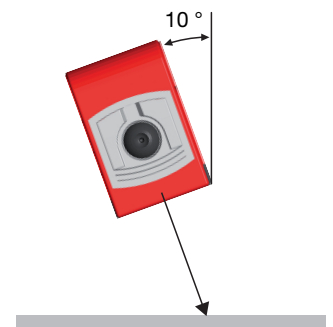

KRTW 3B

White light contrast scanner

Order guide

Selection table		Order code →												
Equipment ↓		KRTW 3B/4.1110-S8 Part no. 50110572	KRTW 3B/4.1121-S8 Part no. 50110576	KRTW 3B/4.1321-S8 Part no. 50110580	KRTW 3B/6.1121-S8 Part no. 50111319	KRTW 3B/2.1110-S8 Part no. 50110573	KRTW 3B/4.1110,200-S12 Part no. 50110574	KRTW 3B/2.1110,200-S12 Part no. 50110575	KRTW 3B/2.1121-S8 Part no. 50110577	KRTW 3B/4.1121,200-S12 Part no. 50110578	KRTW 3B/2.1121,200-S12 Part no. 50110579	KRTW 3B/2.1321-S8 Part no. 50110581	KRTW 3B/4.1321,200-S12 Part no. 50110582	KRTW 3B/2.1321,200-S12 Part no. 50110583
Transmitter color	white light	●	●	●	●	●	●	●	●	●	●	●	●	●
	RGB (red, green, blue)													
	laser-generated red light													
Light spot orientation	vertical	●	●	●	●	●	●	●	●	●	●	●	●	●
	horizontal													
	round													
Output (OUT 1)	PNP transistor output	●	●	●			●			●			●	
	NPN transistor output					●		●	●		●	●		●
	push-pull switching output				●									
	IO-Link COM2				●									
Input (IN)	teach input		●	●	●				●	●	●	●	●	●
Housing	standard		●	●	●				●	●	●	●	●	●
	economy	●				●	●	●						
Connection	M8 connector, metal		●	●	●				●			●		
	M8 connector, plastic	●				●								
	200 mm cable with M12 connector						●	●		●	●		●	●
Teach-in method	static 1-point			●								●	●	●
	static 2-point	●	●		●	●	●	●	●	●				
	dynamic 2-point													
Response time / Switching frequency	50 μs / 10 kHz		●	●	●				●	●	●	●	●	●
	83 μs / 6 kHz	●				●	●	●						
	125 μs / 4 kHz													
Configuration	switching threshold adjustment with EasyTune via teach button		●	●	●				●	●	●	●	●	●
	remote teach, keyboard lockout and pulse stretching via pin 2		●	●	●				●	●	●	●	●	●
	teach level 1, teach-level 2 and pulse stretching via teach button		●	●	●				●	●	●	●	●	●
	teach level 1, teach-level 2 via teach button	●				●	●	●						

IO-Link process data

The sensor transmits 2 bytes to the master.

Data bit																Assignment	Default settings
15	14	13	12	11	10	9	8	7	6	5	4	3	2	1	0		
																Switching output	0 = no mark, 1 = mark detected
																Not used	Free
																Sensor operation	0 = off, 1 = on
																Switching threshold LSB	Value range 0 ... 31 (0 ... 100% in approx. 3% steps) 0% = min. switching threshold 100% = max. switching threshold
Switching threshold																	
Switching threshold																	
Switching threshold MSB																	
																Active transmitter LSB	00 = red, 01 = green or white,
																Active transmitter MSB	10 = blue, 11 = all colors on (teach-in active)
																Not used	Free
																Measurement value LSB	Value range 0 ... 31 (0 ... 100% in approx. 3% steps) 0% = min. signal level 100% = max. signal level
Measurement value																	
Measurement value																	
Measurement value MSB																	







Additional information on the IO-Link service data is available on request.



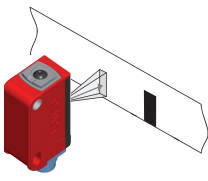
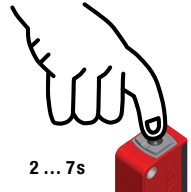

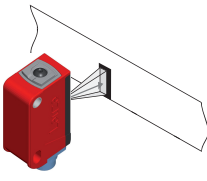
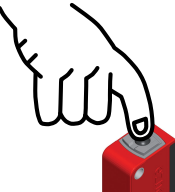
Static 2-point teach

Suitable for manual positioning of the marks (availability dependent on sensor type).

Switching threshold in center:

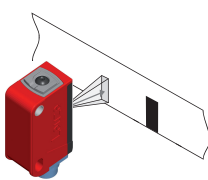
<p>Position the background.</p> 	<p>Press teach button for 2 ... 7s and release.</p>  <p>2 ... 7s</p> <p>Value for background is accepted.</p>	<p>LEDs flash simultaneously.</p>  <p>Simultaneous flashing</p>	<p>Position the mark.</p> 	<p>Briefly press teach button.</p>  <p>Value for mark is accepted.</p>	<p>Sensor in RUN mode. Yellow LED illuminates.</p>  <p>Switching threshold set in the center.</p>
---	--	---	---	---	--

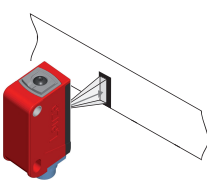
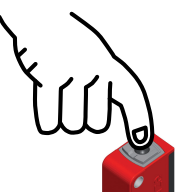
Switching threshold near the mark:

<p>Position the background.</p> 	<p>Press teach button for 7 ... 12s and release.</p>  <p>7 ... 12s</p> <p>Value for background is accepted.</p>	<p>LEDs flash alternately.</p>  <p>Alternating flashing</p>	<p>Position the mark.</p> 	<p>Briefly press teach button.</p>  <p>Value for mark is accepted.</p>	<p>Sensor in RUN mode. Yellow LED illuminates.</p>  <p>Switching threshold is set near the mark.</p>
---	--	---	---	---	---





KRTW 3B

White light contrast scanner



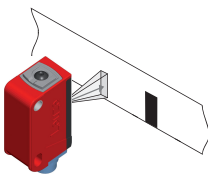
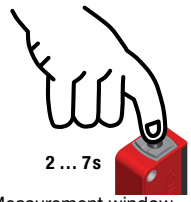

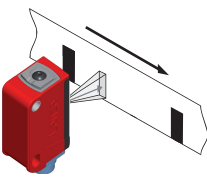
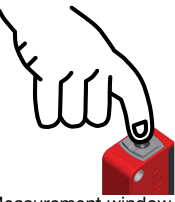
Dynamic 2-point teach

Suitable for marks moved during automated machine processes (availability dependent on sensor type).

Switching threshold in center

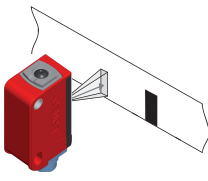
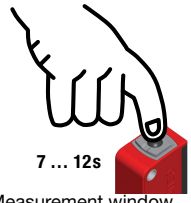
<p>Position the background.</p> 	<p>Press teach button for 2 ... 7s and release.</p> <p>2 ... 7s</p>  <p>Measurement window opens.</p>	<p>LEDs flash simultaneously.</p>  <p>Simultaneous flashing</p>	<p>Allow marks to pass through dynamically.</p> 	<p>Briefly press teach button.</p>  <p>Measurement window closes.</p>	<p>Sensor in RUN mode. Yellow LED is off.</p>  <p>Switching threshold set in the center.</p>
---	--	---	---	--	---

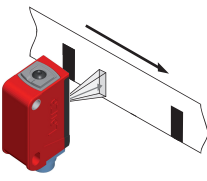
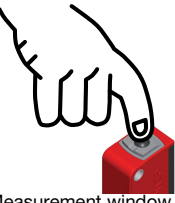

Switching threshold near the mark

<p>Position the background.</p> 	<p>Press teach button for 7 ... 12s and release.</p> <p>7 ... 12s</p>  <p>Measurement window opens.</p>	<p>LEDs flash alternatingly.</p>  <p>Alternating flashing</p>	<p>Allow marks to pass through dynamically.</p> 	<p>Briefly press teach button.</p>  <p>Measurement window closes.</p>	<p>Sensor in RUN mode. Yellow LED is off.</p>  <p>Switching threshold is set near the mark.</p>
---	--	---	---	--	--



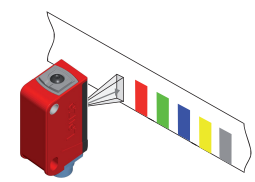
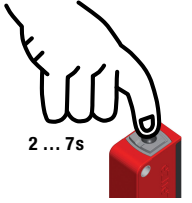
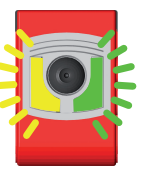
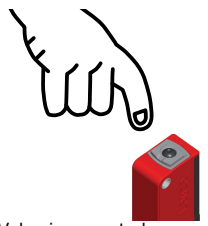

Static 1-point teach

Suitable for detecting all marks outside of the reference value (availability dependent on sensor type).

Standard sensitivity

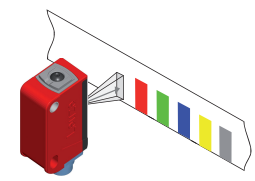
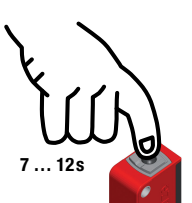
<p>Position the reference value.</p> 	<p>Press teach button for 2 ... 7s.</p> <p>2 ... 7s</p> 	<p>LEDs flash simultaneously.</p>  <p>Simultaneous flashing</p>	<p>Release teach button.</p>  <p>Value is accepted.</p>	<p>Sensor in RUN mode. Yellow LED is off.</p>  <p>Standard sensitivity is set.</p>
--	---	---	---	---

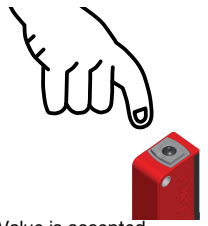
High sensitivity

<p>Position the reference value.</p> 	<p>Press teach button for 7 ... 12s.</p> <p>7 ... 12s</p> 	<p>LEDs flash alternatingly.</p>  <p>Alternating flashing</p>	<p>Release teach button.</p>  <p>Value is accepted.</p>	<p>Sensor in RUN mode. Yellow LED is off.</p>  <p>High sensitivity is set.</p>
--	---	---	---	---

Switching threshold diagrams

Static 2-point teach

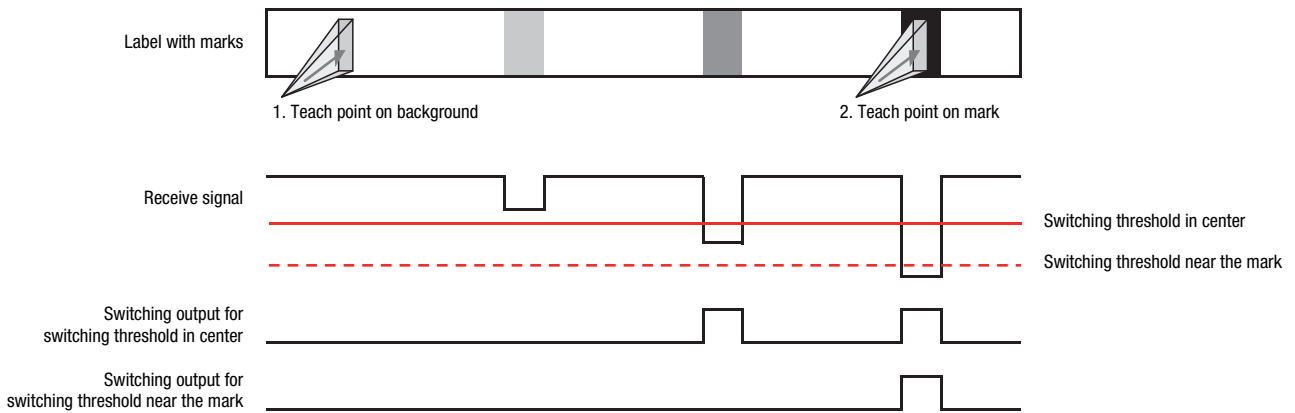

Dynamic 2-point teach

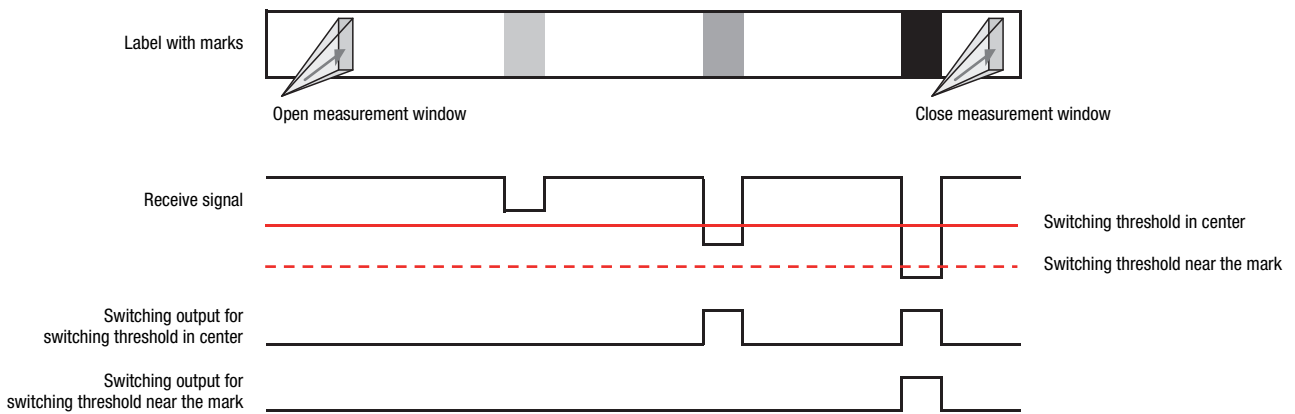

Static 1-point teach

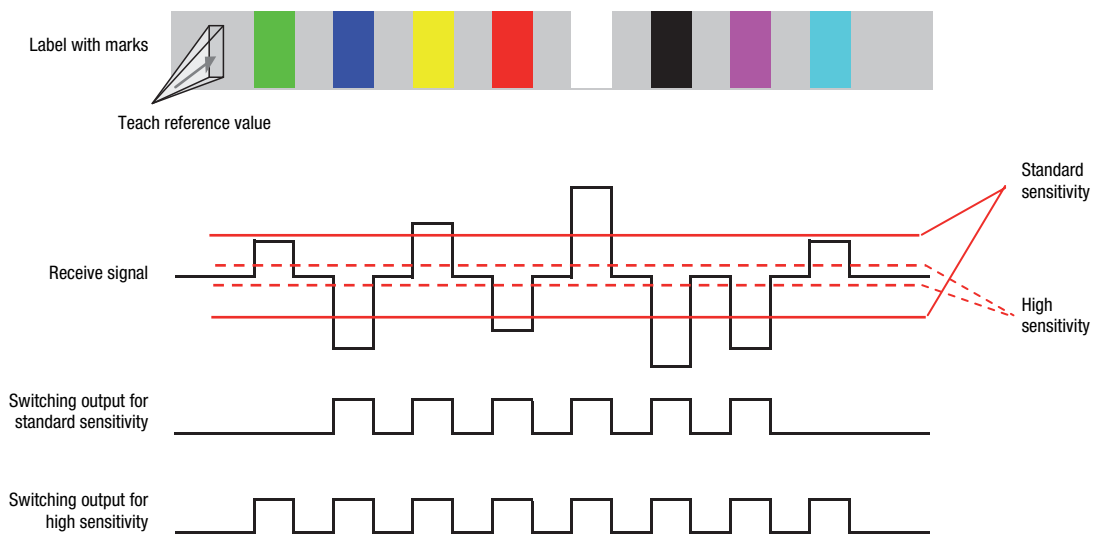

KRTW 3B

White light contrast scanner

Pulse stretching option

Switching pulse stretching on or off:

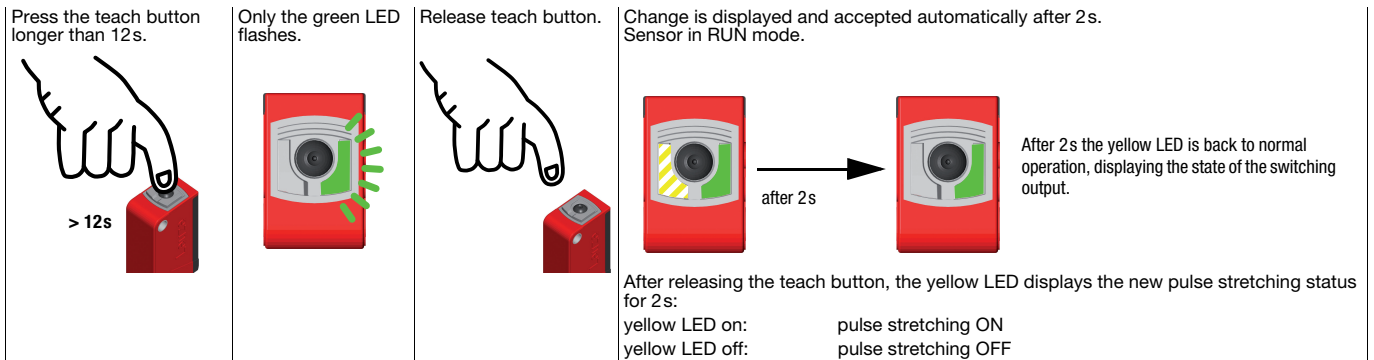

"EasyTune" option - fine tuning of the switching threshold

Following power-on and completed teach event:

Green LED illuminates continuously (ready),
 Yellow LED on/off continuously (mark detected/not detected).

Increasing the switching threshold:

Long press of the button = large force expenditure = increase switching threshold
 Each press of the button with a duration between 200ms and 2s increments the switching threshold.

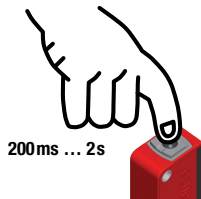

A press of the button is acknowledged by a single, brief flash of the green LED – the new switching threshold is now valid.

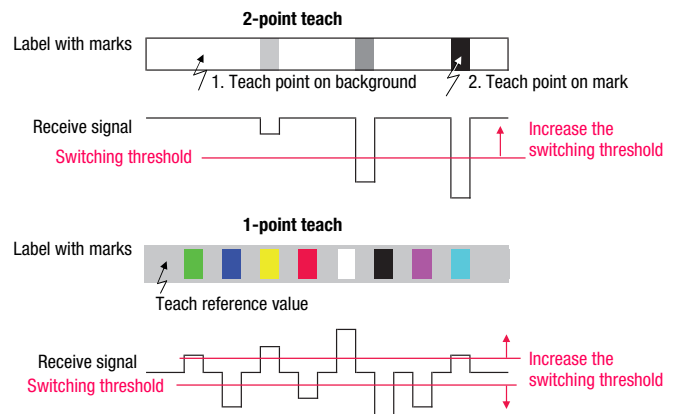

Reducing the switching threshold:

Short press of the button = small force expenditure = reduce switching threshold
 Each press of the button with a duration between 2ms and 200ms decrements the switching threshold.

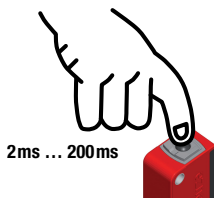

A press of the button is acknowledged by a single, brief flash of the green LED – the new switching threshold is now valid.

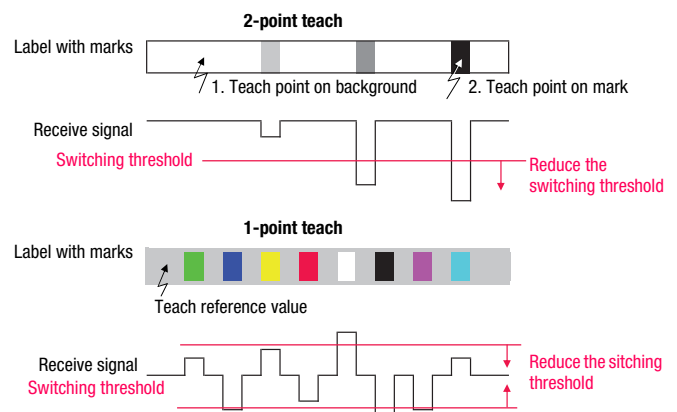

If the upper or lower end of the adjustment range is reached, the green and yellow LEDs flash at a considerably higher frequency of 8Hz for the duration of one second.

Sensor adjustments via the input IN (Pin 2)



The following description applies to PNP switching logic!

Signal level LOW $\leq 2V$

Signal level HIGH $\geq (U_B - 2V)$

With the NPN models, the signal levels are inverted!

Switching threshold in center / standard sensitivity

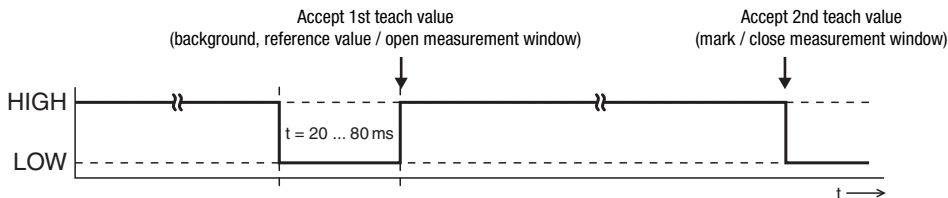

Switching threshold near the mark / high sensitivity

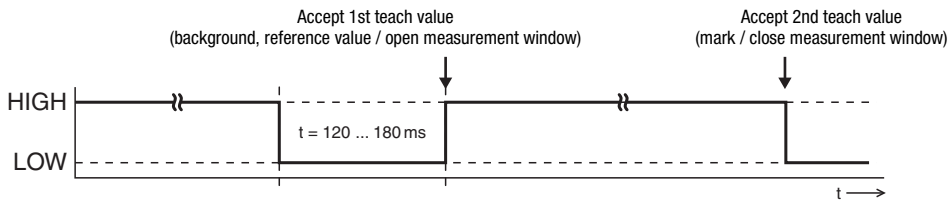

Pulse stretching ON

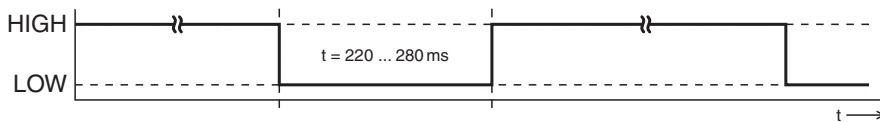

Pulse stretching OFF

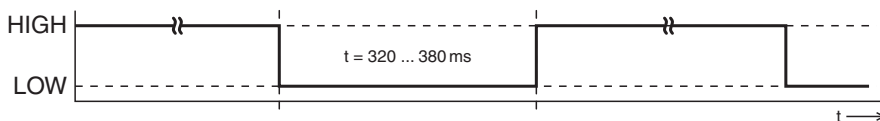

Locking the teach button via the input IN (Pin 2)



A static HIGH signal ($\geq 20ms$) at the teach input locks the teach button on the sensor if required, such that no manual operation is possible (e.g., protection from erroneous operation or manipulation).

If the teach input is not connected or if there is a static low signal, the button is unlocked and can be operated freely.

