

LV462

Amplifier for fiber optics

en 01-2012/05 50118005



up to 525mm
 up to 120mm
 10 - 30 V DC

- 3-digit display for indicating and setting the switching threshold
- NEW: AutoSet function for easy sensor adjustment
- Menu functions for setting the range and various time functions
- Switch for changing between light and dark switching
- PNP or NPN switching output
- Indicator diode for operation and switching output
- Connection via cable or cable with M8 connector

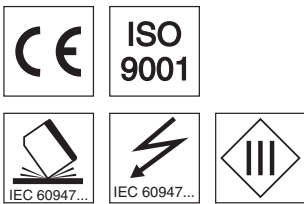

Accessories:

(available separately)

- Plastic fiber optics (KF, KFX)
- Ready-made cables (KB ...)

Dimensioned drawing

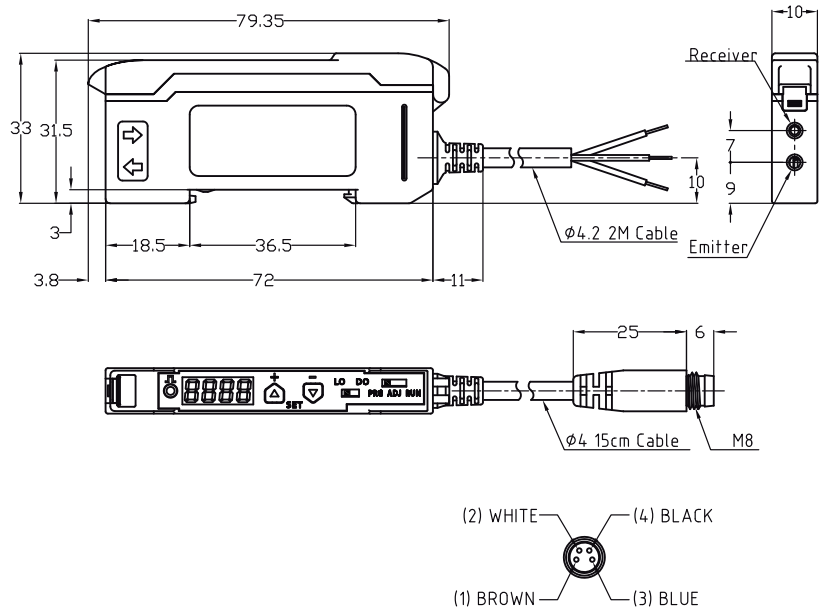

Supplied mounting accessories

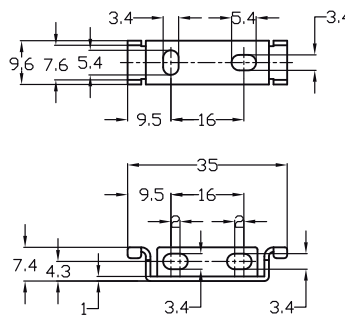

Electrical connection

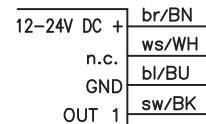
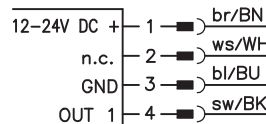

We reserve the right to make changes • DS_LV462_en_50118005.fm

Specifications

Optical data

Operating range/scanning range ¹⁾
Light source
Wavelength

Throughbeam principle

up to 525mm
LED (modulated light)
660nm (visible red light)

Scanning principle

up to 120mm

Timing

Switching frequency ²⁾
Response time
Delay before start-up

Setting SP-H

500Hz
1ms
≤ 450ms

Setting SP-L

250Hz
2ms

Electrical data

Operating voltage U_B
Residual ripple
Open-circuit current
Switching output
.../4...
.../2...

12 ... 24VDC ± 10%
≤ 10% of U_B
≤ 45mA
pin 4/black: PNP
pin 4/black: NPN
light/dark switching, adjustable by means of a switch
switch-on/switch-off delay,
passing contact (on actuation or fall-back),
adjustable times: 2ms, 20ms, 50ms, 100ms, 500ms, 1s, 5s, 10s
≥ ($U_B - 2.5V$) / ≤ 2.5V
≤ 100mA
adjusted using the AutoSet function or +/- buttons

Function
Switching output time functions

Signal voltage high/low
Output current
Sensitivity

Indicators

Red LED
Display

Switching output active
7-segment LED, 4-digit,
display of switching threshold/operating mode,
menu-driven sensor setting

Mechanical data

Housing
Weight
Connection type

ABS
63g with 2000mm cable
70g with 150mm cable and M8 connector
cable 2000mm, 3 x 0.25mm², or
cable 150mm with M8 connector, 4-pin
clamp-mounting, 2 x Ø 2.2mm

Fiber optic connection

Environmental data

Ambient temp. (operation/storage)
Protective circuit ³⁾
Protection class
Standards applied

-10°C ... +60°C / -40°C ... +70°C
2, 3
IP 54
EN 60947-5-2

Options

Sensor setting menu-driven using display and +/- buttons

- 1) Operating range/scanning range dependent on the fiber optics used
2) With a duty cycle of 1:1
3) 2=polarity reversal protection, 3=short circuit protection for all outputs

Order guide

	Designation	Part no.
PNP types		
Connection: cable 2000mm, 3 x 0.25mm ²	LV462.4/4	50118400
Connection: cable 150mm with M8 connector, 4-pin	LV462.4/4X-150-M8	50118401
NPN types		
Connection: cable 2000mm, 3 x 0.25mm ²	LV462.4/2	50118402
Connection: cable 150mm with M8 connector, 4-pin	LV462.4/2X-150-M8	50118403

Tables



Notice!

Detailed specifications on the range/scanning range are enclosed in the data sheets of our fiber optics type **KF** or **KFX**.

Diagrams

Remarks

- **Approved purpose:**
This product may only be used by qualified personnel and must only be used for the approved purpose. This sensor is not a safety sensor and is not to be used for the protection of persons.

Mounting the amplifier

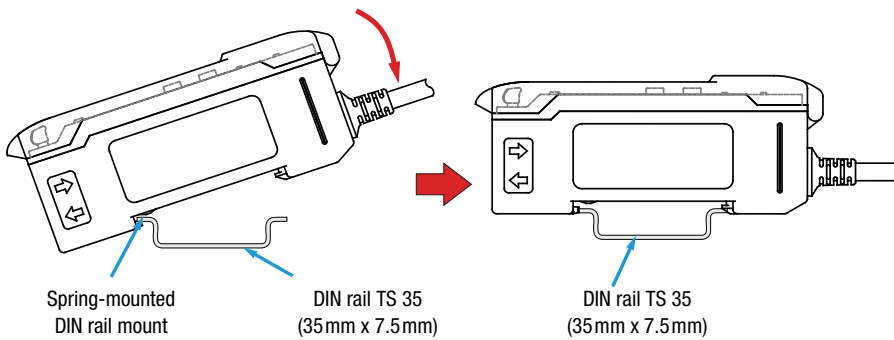

The amplifier is mounted as shown on a TS 35 DIN rail while disconnected from voltage.

Alternatively, the amplifier can also be mounted without a DIN rail using the mounting accessory (supplied) and M3 screws.



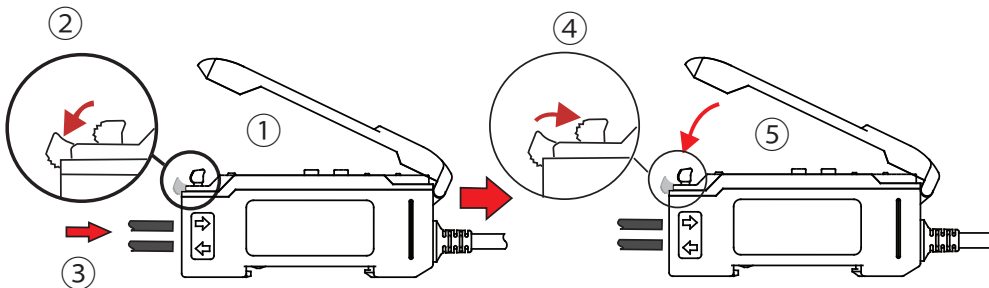



Installing the fiber optics

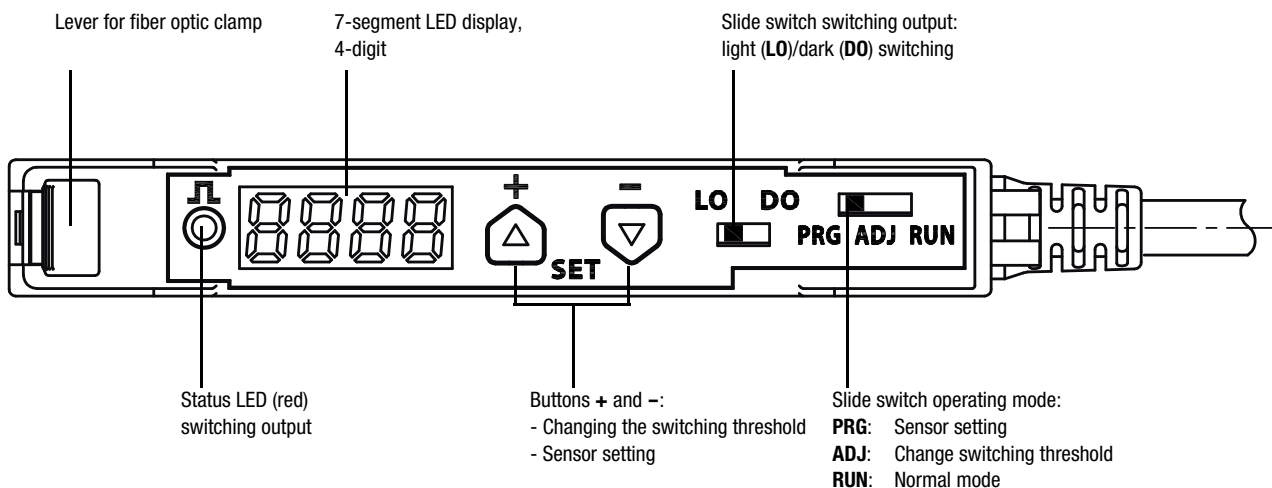

- ① Open the transparent protective cover.
- ② Push down the lever of the fiber optic clamp to open.
- ③ Lead the **KF/KFX** type fiber optics in completely as far as they will go (ca. 12mm deep) into the fiber optic intake.
When doing so, observe the transmitter/receiver assignment on the amplifier (transmitter at bottom / receiver on top).
- ④ Pull up the lever of the fiber optic clamp to close. Check if the clamp is secure by pulling lightly on the fiber optics.
- ⑤ Close the transparent protective cover.

Controls and indicators

























	Selector switch Operating mode	RUN: normal mode - no settings possible ADJ: AutoSet function is possible, switching threshold can be adjusted with buttons + and - PRG: menu-driven device setting via display and buttons + and -
	Selector switch Switching output	LO: switching output light switching : if throughbeam fiber optics are installed, the switching output is active when the light path is free; if a scanning system is installed, the switching output is active when an object is detected. The status LED illuminates when the switching output is active. DO: switching output dark switching : the switching behavior is the inversion of the light switching setting.
	Control buttons + and -	Button +: the value in the display is incremented by 1 digit each time the button is pressed. Button -: the value in the display is decremented by 1 digit each time the button is pressed. Note: If a button is kept pressed, the value in the display is continuously changed in steps of 10.
	Indicator Transmitting power	the first location on the left of the display indicates the set transmitting power in operating modes RUN and ADJ H: standard sending pulse length (setting SP-H) L: long sending pulse for more range (setting SP-L)
	Indicator Switching threshold	the 3 locations to the right of the screen indicate the set switching threshold in operating modes RUN and ADJ (value range: 000 ... 999). depending on the setting LO / DO , the sensor switches when the set switching threshold value is undershot or overshot.
	Status LED (red) Switching output state	LED ON switching output active. LED OFF switching output inactive.

Menu-driven sensor setting

The LV462 can be adjusted to meet customer requirements with a simple menu-driven system. To do this, set the **selector switch** for the **operating mode** to position **PRG**.



Function	Direction of movement in the menu  on pressing the button				
Sending pulse length (Sending pulse)					
	short	long			
Sending pulse power (Power)					
	50%	100%			
Display brightness (Power save)					
	standard	reduced	minimum		
	Time function (Delay)				
no time function		start-up delay	switch-off delay	passing contact on actuation	passing contact on fall-back
					
t = 2ms		t = 20ms	t = 50ms	t = 100ms	t = 500ms
Delay time					
	t = 1s	t = 5s	t = 10s		
	Display orientation (Display position)				
standard		turned by 180°			

Time functions

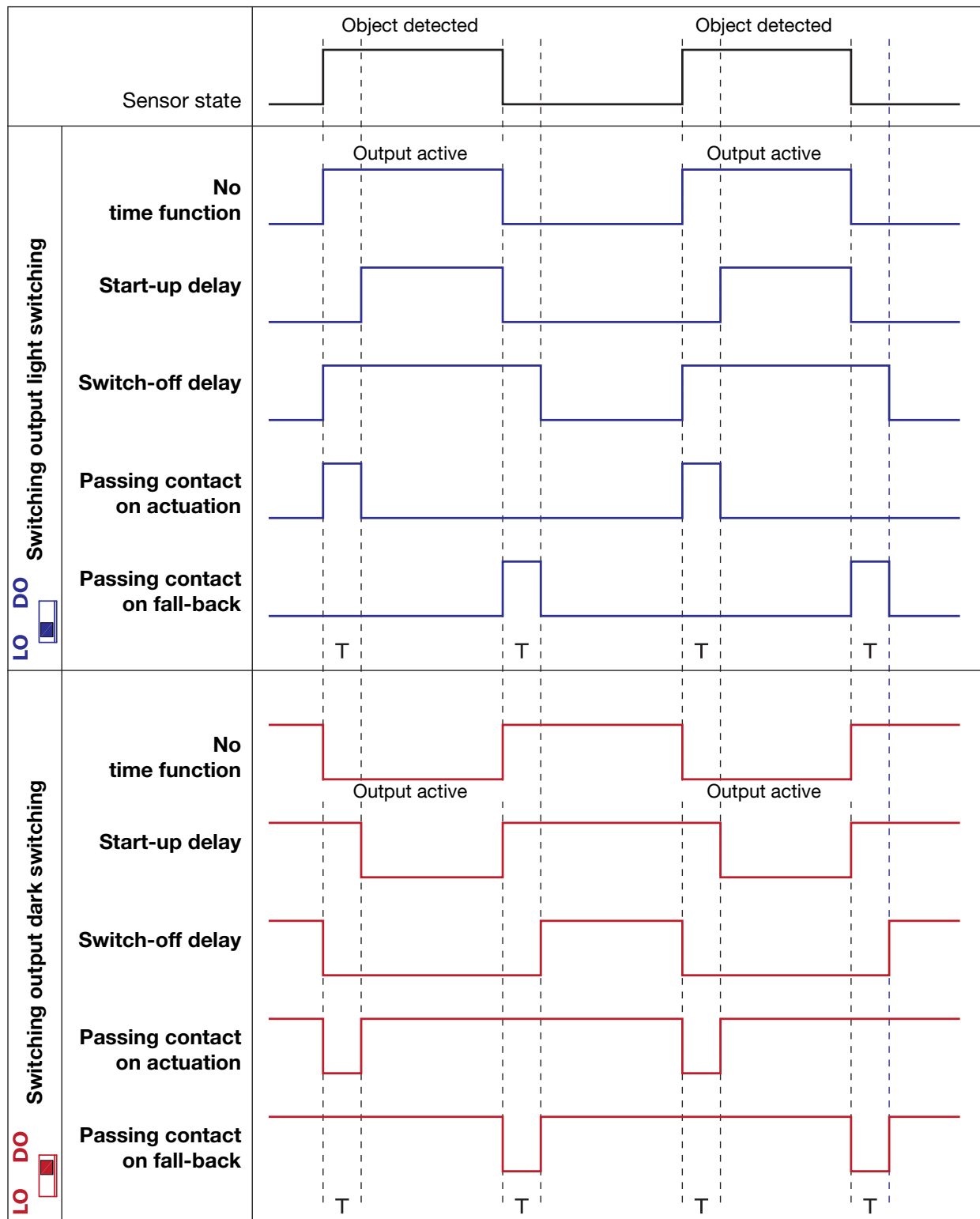

T is the set delay time dt-1 ... dt-8.

Only one of the four possible time functions can be activated at any given time. First select the required function and then assign a delay time to it.

Example: A switch-off delay of 100ms is to be set

1. Select "switch-off delay" time function:

2. Select "100ms" delay time:

Adjusting the operating range

Menu functions **sending pulse length** and **sending pulse power** are used to adjust the range.

Setting in the menu:

- SP-L / Po-2** XLR = 4 x SR maximum operating/scanning range (extra long range)
- SP-L / Po-1 or SP-H / Po-2** LR = 2 x SR medium operating/scanning range (long range)
- SP-H / Po-1** SR minimum operating/scanning range (standard range)

Recommended settings:

Application	Type of object	Object size	Operating/scanning range	Range	Configuration
Scanning system	not transparent	any	long	XLR	SP-L / Po-2
	not transparent	large, plane	medium	LR	SP-L / Po-1 SP-H / Po-2
	transparent		long	XLR	SP-L / Po-2
			medium	LR	SP-L / Po-1 SP-H / Po-2
Throughbeam system	not transparent	rather large	long	XLR	SP-L / Po-2
	not transparent	small parts	medium	LR	SP-L / Po-1 SP-H / Po-2
	transparent	any	long	LR	SP-L / Po-1 SP-H / Po-2
			short	SR	SP-H / Po-1

Adjusting the switching threshold

To set the switching point, the switching threshold must be set.

To set the switching threshold, set the **selector switch** for the **operating mode** to the **ADJ** position.



The switching output is active when

- the switching threshold in the **light switching setting (LO)** is **overshot** by the reception signal in the sensor.
- the switching threshold in the **dark switching setting (LD)** is **undershot** by the reception signal in the sensor.

Setting the switching threshold using the AutoSet function

(based on the example of a scanning system - a throughbeam system is set analogous to this)

Switching output light switching	LO DO	Switching output dark switching	LO DO
Selector switch switching output in position LO , Setting to maximum range SP-L / Po-2		Selector switch switching output in position DO , Setting to maximum range SP-L / Po-2	
<ol style="list-style-type: none"> ① Place object in light beam. ② Press button - and reduce switching threshold to 000. The red status LED for the switching output is OFF. ③ Press button + and keep pressed until the red status LED for the switching output is ON. Release the button. ④ Ready - the sensor is now set. ④ Check cut-in/cut-out point. Fine adjustment of the switching threshold is possible by briefly pressing button + or -. 		<ol style="list-style-type: none"> ① Place object in light beam. ② Press button - and reduce switching threshold to 000. The red status LED for the switching output is ON. ③ Press button + and keep pressed until the red status LED for the switching output is OFF. Release the button. ④ Ready - the sensor is now set. ④ Check cut-in/cut-out point. Fine adjustment of the switching threshold is possible by briefly pressing button + or -. 	
Remarks: The sensor is optimally set when the displayed switching threshold is 50 ... 100 digits. If the displayed value is smaller, reduce the range. If the value shown is near to setting limit 999 , then set a higher range. If, at a displayed value of 999 , the status LED is not ON , then the range is too low. Check the range setting, reduce the object distance.		If, at a displayed value of 999 , the status LED is not OFF , then the range is too low. Check the range setting, reduce the object distance.	

Manual adjusting of the switching threshold

If the **selector switch** for the **operating mode** is in the **ADJ**, position, the switching threshold can be set manually.

Button **+**: The switching threshold in the display is incremented by 1 digit each time the button is pressed.

Button **-**: The switching threshold in the display is decremented by 1 digit each time the button is pressed.

If a button is kept pressed, the value in the display is continuously changed in steps of 10.