

**HRTR 318**

**Diffuse reflection light scanner with background suppression**

Part No. 501 08673



**1 ... 140mm**



- Exact background suppression, electronically adjustable
- Nearly colour-independent object detection
- Clearly visible red light spot
- High switching frequency for detection of fast events
- A²LS - Active Ambient Light Suppression
- Very short, robust cylindrical stainless steel or plastic housing with straight optics



**Accessories:**

(available separately)

- Mounting systems (BT 318, BT 318-ARH)
- M12 connectors (KD ...)
- Ready-made cables (K-D ...)

**Dimensioned drawing**

HRTR 318M/...

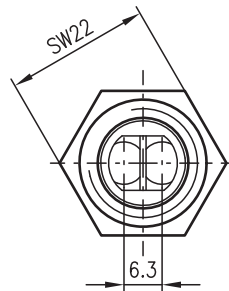
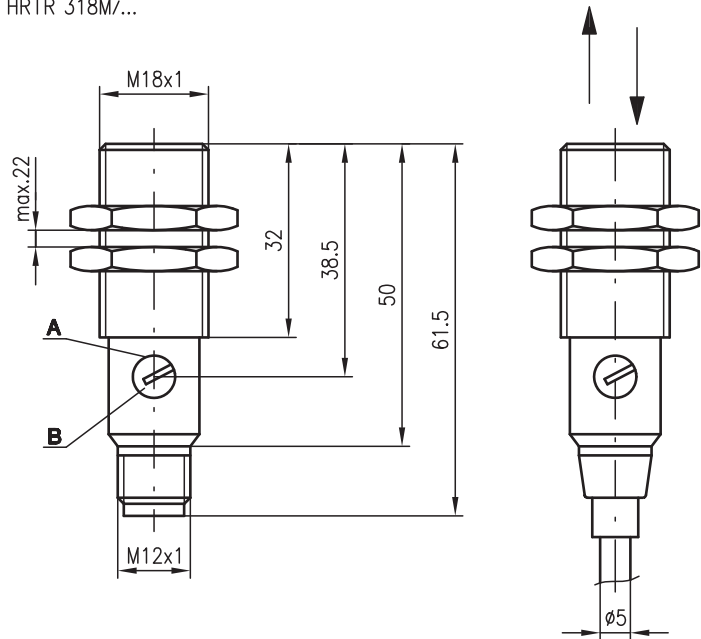

HRTR 318K/...

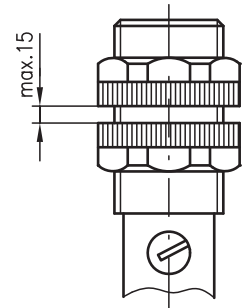

- A** Indicator diode
- B** Sensitivity adjustment

**Electrical connection**

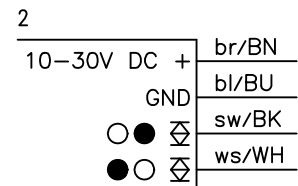
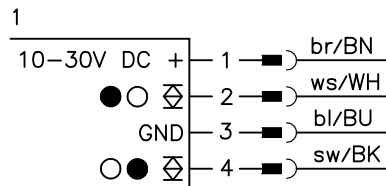

We reserve the right to make changes • 318\_d02gb.fm

## Specifications

### Optical data

Typ. scanning range limit (white 90%) <sup>1)</sup>	1 ... 140mm
Scanning range <sup>2)</sup>	see tables
Adjustment range	40 ... 140mm
Light source	LED (modulated light)
Wavelength	625nm (visible red light)

### Timing

Switching frequency	1000Hz
Response time	0.5ms
Delay before start-up	≤ 100ms

### Electrical data

Operating voltage $U_B$	10 ... 30VDC
Residual ripple	≤ 10% of $U_B$
Bias current	≤ 15mA
Switching output	.../66. ... 2 push-pull switching outputs <sup>3)</sup> pin 2: PNP dark switching, NPN light switching pin 4: PNP light switching, NPN dark switching ≥ ( $U_B - 2V$ ) / ≤ 2V max. 100mA
Signal voltage high/low	potentiometer, 270°
Output current	
Scanning range adjustment	

### Indicators

LED yellow	object detected
------------	-----------------

### Mechanical data

Housing	polyamide 12 or stainless steel
Optics cover	polycarbonate
Weight	plastic housing: 85g (cable), 15g (M12) stainless steel housing: 105g (cable), 35g (M12)
Connection type	M12 connector, 4-pin cable 2m, 4x0.25mm <sup>2</sup>

### Environmental data

Ambient temp. (operation/storage)	-25°C ... +65°C / -40°C ... +70°C
Protective circuit <sup>4)</sup>	2, 3
VDE safety class <sup>5)</sup>	II, all-insulated
Protection class	IP 67
LED class	1 (acc. to EN 60825-1)
Standards applied	IEC 60947-5-2

- 1) Typ. scanning range limit: max. attainable range without performance reserve
- 2) Scanning range: recommended range with performance reserve
- 3) The push-pull switching outputs must not be connected in parallel
- 4) 2=polarity reversal protection, 3=short-circuit protection for all outputs
- 5) Rating voltage 250VAC

## Tables

1	1	120	140
2	5	110	130
3	8	100	120

1	white 90%
2	grey 18%
3	black 6%

<input type="checkbox"/>	Scanning range [mm]
<input type="checkbox"/>	Typ. scanning range limit [mm]

## Diagrams

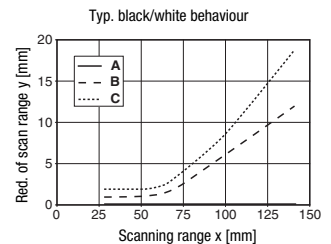

- A white 90%
- B grey 18%
- C black 6%

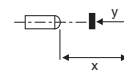

## Order guide

Selection table		Order code →							
Equipment ↓		HRTR 318K/66-120-S12 Part No. 501 06085	HRTR 318M/66-120-S12 Part No. 501 06086	HRTR 318K/66-120 Part No. 501 06089	HRTR 318M/66-120 Part No. 501 06090				
Housing	plastic	●		●					
	stainless steel		●		●				
Connection	M12 connector	●	●						
	cable			●	●				
Switching output	2 x push-pull	●	●	●	●				
Connection diagram		1	1	2	2				

## Remarks

### Approved purpose:

The diffuse reflection light scanners are optical electronic sensors for optical, contactless detection of objects.