

HRTU 418 RM/WM

Ultrasonic sensors

Art. Nr. 50108367



25 ... 400mm
50 ... 700mm



- Colour and transmission independent detection of objects
- Switching behaviour largely independent of surface properties
- Two mutually independent switching points
- Distance teachable
- Small construction

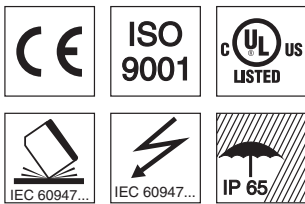

Accessories:

(available separately)

- Mounting systems
- Cable with M12 connector (K-D ...)

Dimensioned drawing

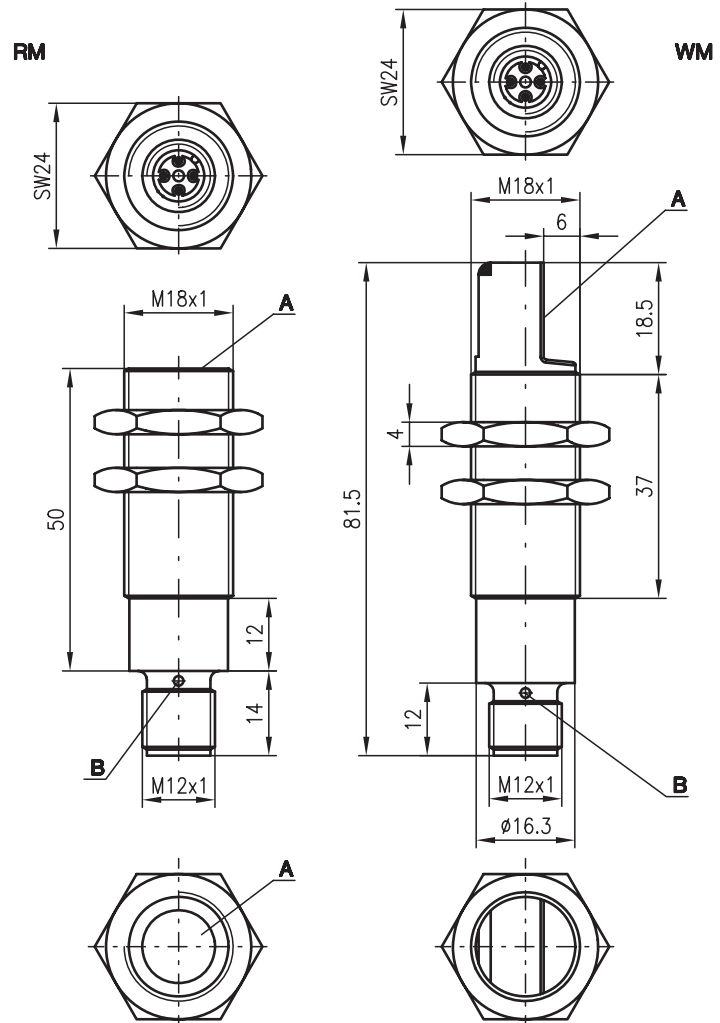

- A** Active surface
- B** Indicator diode Q1, Q2

Electrical connection

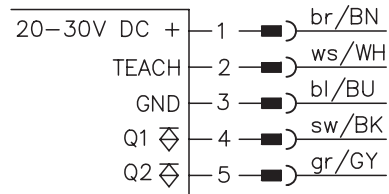

We reserve the right to make changes • USDS_13gb.fm

Specifications

Ultrasonic specifications

Operating range ¹⁾
 Adjustment range
 Ultrasonic frequency
 Typ. opening angle
 Resolution
 Direction of beam

HRTU 418 ...-400-S12

25 ... 400mm
 40 ... 400mm
 300kHz
 see diagrams

HRTU 418...-700-S12

50 ... 700mm
 75 ... 700mm
 200kHz

Reproducibility
 Switching hysteresis
 Temperature drift

1mm
 HRTU 418RM/P...: straight,
 HRTU 418WM/P...: angular, 90°
 ± 1mm
 10mm
 ± 0.17%/K

Timing

Switching frequency
 Response time
 Delay before start-up

10Hz
 50ms
 20ms
 5Hz
 100ms

Electrical data

Operating voltage U_B
 Residual ripple
 Bias current
 Switching output
 Function characteristics
 Output current
 Switching range adjustment

20 ... 30V DC (incl. ± 10% residual ripple)
 ± 10% of U_B
 ≤ 20mA
 2x PNP transistor
 switching in case of object recognition
 300mA
 teach-in Q1: teach input (pin 2) connected to GND for
 3 ... 6s
 teach-in Q2: teach input (pin 2) connected to GND for
 6 ... 9s

Indicators

Yellow LED
 Flashing yellow LED

output Q1, output Q2
 teaching procedure

Mechanical data

Housing
 Weight
 Connection type

metal/brass nickel-plated
 50g
 M 12 connector, plastic, 5-pin

Environmental data

Ambient temp. (operation/storage)
 Protective circuit ²⁾
 VDE safety class
 Protection class
 Standards applied
 Fitting position

-25°C ... +70°C/-40°C ... +85°C
 1, 2, 3
 III
 IP 65
 IEC 60947-5-2
 any

1) For the complete temperature range, measured object ≥ 20x20mm
 2) 1=short-circuit and overload protection, 2=polarity reversal protection, 3=wire break and inductive protection

Tables

Diagrams

HRTU 418 ...-400-S12

Typ. response behaviour (object 20x20mm)

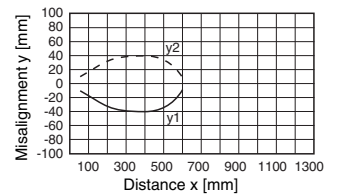

HRTU 418 ...-700-S12

Typ. response behaviour (object 20x20mm)

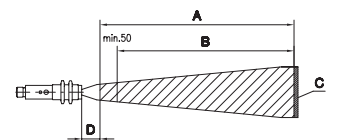
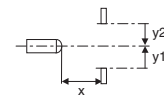
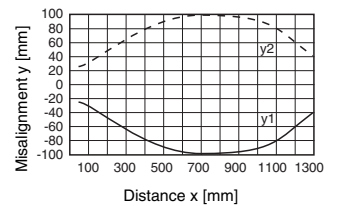

- A Operating range
- B Adjustment range
- C Object
- D Dead zone

Order guide

	Designation	Part No.
Operating range: 25 ... 400mm, direction of beam: straight	HRTU 418RM/P-5220-400-S12	501 09016
Operating range: 25 ... 400mm, direction of beam: 90°	HRTU 418WM/P-5220-400-S12	501 09017
Operating range: 50 ... 700mm, direction of beam: straight	HRTU 418RM/P-5220-700-S12	501 09018
Operating range: 50 ... 700mm, direction of beam: 90°	HRTU 418WM/P-5220-700-S12	501 09019

Remarks

- **Approved purpose:**
The ultrasonic sensors are used for acoustic, contactless detection of objects.
- **Temperature drift**
± 0.17%/K

Teach-in via input

1. Position measurement object at the desired distance.
2. The respective teach function is activated by applying GND to the teach input (pin 2).
The teach event is signalled by slow flashing of the LEDs.

Teach function	Teach phase / duration of the teach signal	LED Q1	LED Q2
Teach preparation	A / 0 ... 3s	off	off
switching output Q1	B / 3 ... 6s	flashes	off
switching output Q2	C / 6 ... 9s	off	flashes

3. To finish the teach event, disconnect the teach input from GND or switch it to $+U_B$ after the desired time. If the teach event has not completed after 9s, it begins again with phase B.
4. A successful teach event is signalled by the end of the flashing.

Error messages

LEDs which continuously flash fast signal an unsuccessful teach event (sensor not ready):

LED Q1	LED Q2	Error
flashes rapidly	switching state output Q2	teach switching output Q1 unsuccessful
switching state output Q1	flashes rapidly	teach switching output Q1 unsuccessful

Remedy:

- Disconnect sensor from voltage to restore the old values.
- Repeat teach event

