

IPRK 18

Retro-reflective photoelectric sensors with polarization filter

en 04-2012/06 50110546

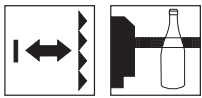

0 ... 3m



- Intelligent sensor for detection of transparent objects (e.g. clear glass, PET, foil) with integrated AS-i slave
- Automatic contamination compensation (tracking function) for longer intervals between cleanings
- Sensor adjustment via bus line and teach-in directly at sensor

Dimensioned drawing

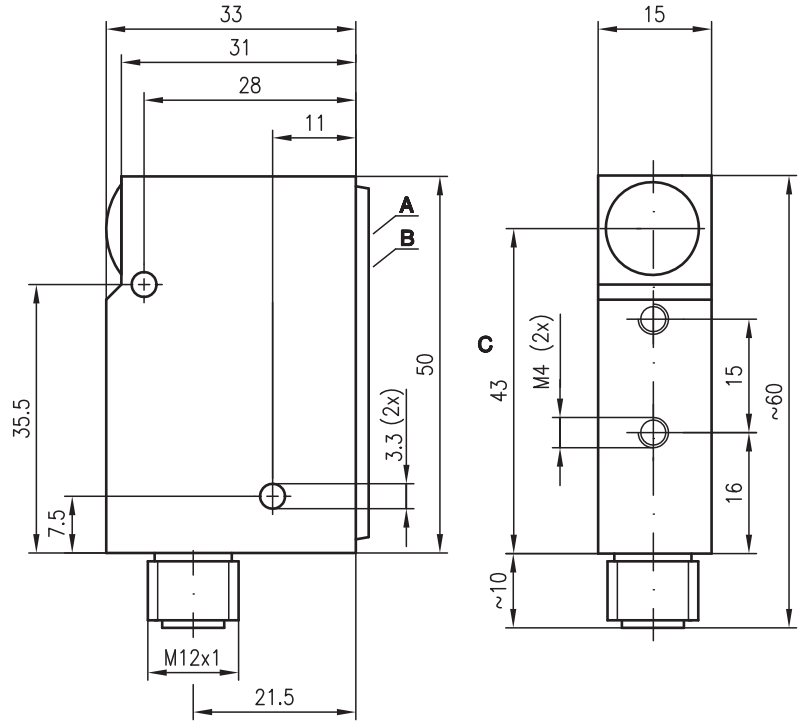

- A** Step switch for object adjustment
- B** Indicator diodes
- C** Optical axis

Electrical connection

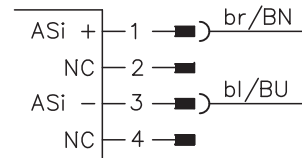

We reserve the right to make changes • DS_IPRK18AL46_en_50110546.fm

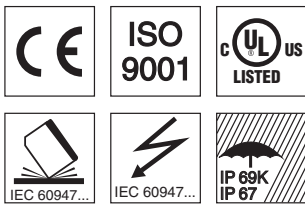

Accessories:

(available separately)

- Mounting system (BT 95)
- M12 connectors (KD ...)
- Reflectors

Specifications

Optical data

Typ. operating range limit (TK(S) 100x100) ¹⁾ 0 ... 3m
 Operating range ²⁾ see tables
 Recommended reflector MTKS 50x50.1
 Light source LED (modulated light)
 Wavelength 660nm (visible red light, polarized)

Timing

Switching frequency (sensor) according to AS-i specifications (500Hz internally)
 Response time (sensor) according to AS-i specifications (1 ms internally)
 Delay before start-up ≤ 300ms

Electrical data

Operating voltage U_B 26.5V ... 31.6V (according to AS-i specification)
 Open-circuit current ≤ 35mA
 Sensitivity changeover: PET/clear glass/colored glass

Switch positions

Position **teach-in** activation of the teach event
 Position **1** (PET bottle) operating point PET bottle
 Position **2** (clear glass bottle) operating point clear glass bottle
 Position **3** (colored glass bottle) operating point colored glass bottle
 Position **Auto** Tracking ON/OFF

Indicators (see also Controls and indicators)

Green LED, continuous light ready
 Green LED, flashing teach mode active with performance reserve
 LED, red/green continuous light operation without performance reserve
 LED, red continuous light/green flashing teaching without performance reserve
 Green/red LED flashing device defective
 LED 1, yellow light path free
 LED 2, yellow tracking ON
 LED 3, yellow AS-i ON = step switch OFF

Mechanical data

Housing diecast zinc
 Optics cover glass
 Weight 150g
 Connection type M12 connector, 4-pin, stainless steel

Environmental data

Ambient temp. (operation/storage) -25 °C ... +55 °C / -40 °C ... +70 °C
 Protective circuit ³⁾ 2, 3
 VDE safety class III
 Protection class IP 67, IP 69K ⁴⁾
 LED class 1 (acc. to EN 60825-1)
 Standards applied IEC 60947-5-2

AS-i data

I/O code 7
 ID code A.F
 Address programmed by the user in the range of 1 to 62 (default=0)
 max. 10ms for 62 slaves
 AS-i standard according to profile S-7.A.F (A/B-operation, user defined)

1) Typ. operating range limit: max. attainable range without performance reserve
 2) Operating range: recommended range with performance reserve
 3) 2=polarity reversal protection, 3=short circuit protection for all outputs
 4) IP 69K test acc. to DIN 40050 part 9 simulated, high pressure cleaning conditions without the use of additives, acids and bases are not part of the test

Approved purpose:

This product may only be used by qualified personnel and must only be used for the approved purpose. This sensor is not a safety sensor and is not to be used for the protection of persons.

Order guide

Designation	Part no.
IPRK 18/A L.46	50040278

Tables

Reflectors	Operating range
1 TK(S) 100x100	0 ... 2.4m
2 MTKS 50x50.1	0 ... 2.0m
3 TK(S) 30x50	0 ... 0.8m
4 TK(S) 20x40	0 ... 0.8m
5 Tape 6 50x50	0 ... 1.8m

1	0	2.4	3.0
2	0	2.0	2.5
3	0	0.8	1.0
4	0	0.8	1.0
5	0	1.8	2.0

□ Operating range [m] *)
 □ Typ. operating range limit [m] *)

*) for sensitivity setting at switch position 3

TK ... = adhesive
 TKS ... = screw type
 Tape 6 = adhesive

Diagrams

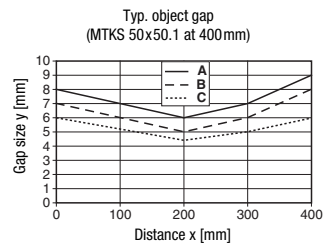

A Switch position 1
 B Switch position 2
 C Switch position 3

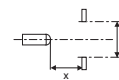

Remarks

Objects	Switch position
Multilayer foil, PET bottles, transparent glass pane	1
Clear glass bottle	2
Colored glass bottle	3

- Teach event may only be performed with free light path.
- A change of the operating point is always possible and does not require a new teach-in.
- Red LED signals unstable operating state.
- For activation of the single functions you have to remain in the respective switch position for approx. 2s.
- In switch positions "Teach" and "Auto" the switching outputs are inactive.
- The light spot may not exceed the reflector.
- Preferably use MTK(S) or tape 6.
- For foil 6 the sensor's side edge must be aligned parallel to the side edge of the reflective tape.

IPRK 18

1. Operating principle of contamination compensation (tracking function)

This transparency sensor (clear glass sensor) is a device which automatically compensates system contamination at the reflector and sensor by means of continuous measurement of the receiving level. The control rate depends on the number of gaps in the process. This tracking function increases the interval between cleaning sessions considerably.

2. Controls and indicators

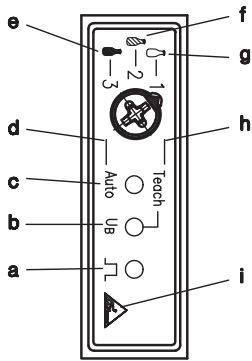

- a Light path free (LED 1 yellow)
- b Operation and teach indicator (LED green/red)
- c Tracking ON (LED 2 yellow)
- d Tracking switch position ON/OFF
- e Switch position 3 (colored-glass bottle)
- f Switch position 2 (clear-glass bottle)
- g Switch position 1 (PET bottle, glass pane, foil)
- h Switch position Teach
- i AS-i ON = step switch OFF (LED 3, yellow)

3. Sensor operation

The sensor can be operated via AS-i and also via the step switch. The step switch can be switched off partially via AS-i. In all cases the teach-in function of the step switch remains.

Enabling the step switch is signaled via the LED 3 = off behind the AS-i icon (DO0=0 and DO1=0). In this mode the AS-i has an influence only on the P₀ and P₁ parameters, as these functions directly affect the DI₀ switching output. The DO₂ and P₂ functions are not active (blocked) in this case. When the changeover from AS-i to the step switch occurs, the current step switch setting will be activated, i. e. changeover to the respective mode (1, 2, 3 or teach-in) takes place. The tracking function remains at the setting which was last set by the AS-i. The changeover of the performance reserve takes effect only after a teach event that had already been started (via AS-i and/or step switch), has been completed. If a changeover from step switch mode to AS-i mode occurs during a teach event, this particular teach event will start again after 2 seconds.

4. Programming via AS-i

AS-i data			
Profile	S-7.A.F (A/B-operation, user defined)	ID code	A.F
I/O code	7	Address	Programmed by the user in the range of 1 to 62 (default=0)

Data and parameter bit assignment (host-level programming)			
DO ₀	Performance reserve L-bit	DI ₂	Not assigned
DO ₁	Performance reserve H-bit	DI ₃	Not assigned
DO ₂	Tracking On/Off	P ₀	Timer On/Off (pulse stretching 12ms as for IPRK 18/A.1 L.4)
DO ₃	Must not be used	P ₁	Light/dark switching
DI ₀	Switching output	P ₂	Teach-in
DI ₁	Warning output (soiling/tracking controller at limit stop)	P ₃	Must not be used

Data content (host-level programming)			
DO₀	DO₁	Performance reserve	
0	0	Step switch enabled (selection possible via step switch 1, 2, 3, via teach-in, via tracking On/Off) => AS-i tracking On/Off and AS-i teach-in are not active (blocked) => AS-i timer On/Off and AS-i light/dark switching are active	
0	1	PET setting => Selection via step switch 1, 2, 3 blocked and tracking On/Off blocked => Teach-in possible via step switch	
1	0	Clear glass setting => Selection via step switch 1, 2, 3 blocked and tracking On/Off blocked => Teach-in possible via step switch	
1	1	Colored glass setting => Selection via step switch 1, 2, 3 blocked and tracking On/Off blocked => Teach-in possible via step switch	

DO ₂	Tracking On/Off (only if DO ₀ = 1 or DO ₁ = 1)	DI ₀	Switching output	DI ₁	Warning output (Soiling/tracking controller at limit stop)
0	Tracking Off	0	No reflection	0	Prefailure message as for standard tracking sensor
1	Tracking On	1	Reflection	1	o.k.

Parameter content (host-level programming)

P ₀	Timer On/Off	P ₁	Light/dark switching	P ₂	Teach-in (only if D ₀ = 1 or D ₀ = 1)
0	Function as for IPRK 18/A L.4 (Timer off)	0	Dark switching	0	Carry out teach-in
1	Function as for IPRK 18/A.1 L.4 (Timer on)	1	Light switching	1	Not active

Minimal switching pulse for P₀ = 1 (Timer on)

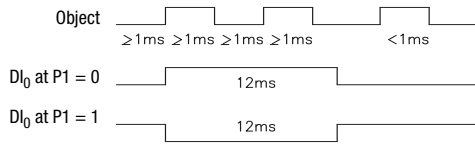

5. Adjustment procedure (teach-in) via step switch

	Correct adjustment procedure:	Important to note:
<p>Reflector</p> <p>STOP</p> <p>Retro-reflective-photoelectric sensor</p> <p>Important during teach-in: free light path!</p>	<ol style="list-style-type: none"> 1. There must be no objects in the beam path between the retro-reflective photoelectric sensor and the reflector during the adjustment procedure. 2. Align the sensor with the reflector so that the light spot is visible in the middle of the reflector. 	<p>The teach-in procedure must be conducted without any objects!</p> <p>The light spot must not fall outside the reflector area. The mounted reflector should always be larger than the visible light spot!</p>
	<p>see 3.)</p> <p>see 4.)</p>	<ol style="list-style-type: none"> 3. Turn the step switch to the "Teach" switch position for about 2s. 4. Turn the step switch back to switch positions 1, 2 or 3.
	<ol style="list-style-type: none"> 5. To turn the tracking function on/off, turn the step switch to the "Auto" switch position for about 2s. 6. Turn the step switch back to switch positions 1, 2 or 3. 	<p>The step switch must be turned to switch positions 1, 2 or 3 during operation!</p>

6. Setting operating mode

Object to be detected	Material, e.g.:	Switch position	Correct adjustment procedure:
<p>① Transparent objects</p>	<ul style="list-style-type: none"> ● PET bottle ● PEN bottle ● Clear plate glass ● Foil 		<ol style="list-style-type: none"> 1. Turn the step switch to the "Teach" switch position for about 2s 2. Turn the step switch back to switch position 1 <p>Tracking can be turned on or off by switching to the "Auto" switch position</p>
<p>⚡ Less transparent objects</p>	<ul style="list-style-type: none"> ● Clear glass bottle ● Colored plate glass 		<ol style="list-style-type: none"> 1. Turn the step switch to the "Teach" switch position for about 2s 2. Turn the step switch back to switch position 2 <p>Tracking can be turned on or off by switching to the "Auto" switch position</p>
<p>⚡ Opaque objects</p>	<ul style="list-style-type: none"> ● Colored glass bottle ● Opaque objects 		<ol style="list-style-type: none"> 1. Turn the step switch to the "Teach" switch position for about 2s 2. Turn the step switch back to switch position 3 <p>Tracking can be turned on or off by switching to the "Auto" switch position</p>