



LS 96

Throughbeam photoelectric sensors



150m

10 - 30 V
DC



- Throughbeam photoelectric sensors with high performance reserve in infrared light
- Robust metal housing with glass cover, protection class IP 67/IP 69K for industrial application
- Complementary outputs, sensitivity adjustment and delay before start-up for optimal adaptation to the application
- Connection via M12 connector or terminal compartment
- Multiple options with warning output, activation input, switching delays and optics heating for use at low temperatures



Accessories:

(available separately)

- Mounting systems (BT 96, BT 96.1, UMS 96, BT 450.1-96)
- M12 connectors (KD ...)
- Ready-made cables (K-D ...)
- Alignment aid ARH 96

Dimensioned drawing

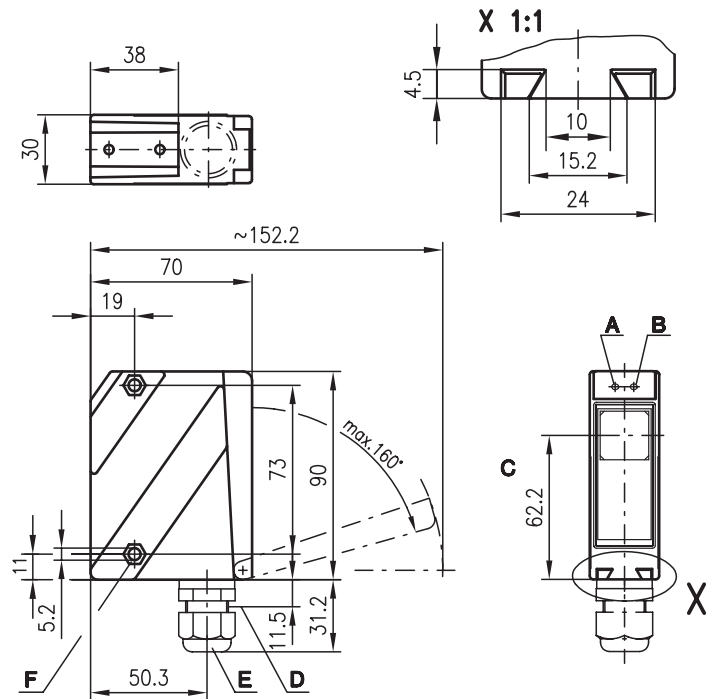

- A Indicator diode green
- B Indicator diode yellow
- C Optical axis
- D Device plug M12x1
- E Screwed cable gland M16x1.5 for Ø 5 ... 10mm
- F Countersinking for SK nut M5, 4.2 deep
- G Connection terminals
- H Cable entry
- I Sensitivity adjustment

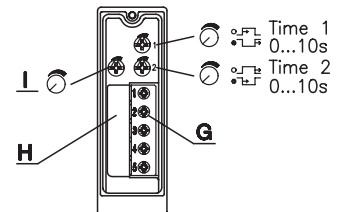

Electrical connection

Transmitter

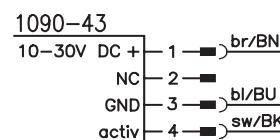
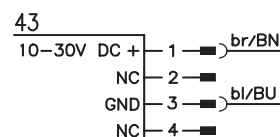
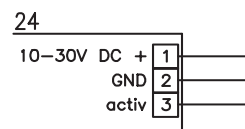

Receiver

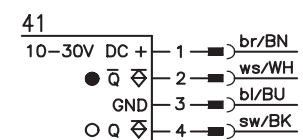
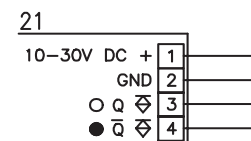
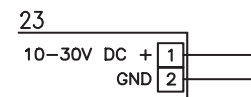

Specifications

Optical data

Typ. operating range limit ¹⁾
 Operating range ²⁾
 Light source
 Wavelength

Infrared light

0 ... 150m
 0 ... 120m
 LED (modulated light)
 880nm

Timing

Switching frequency 500Hz
 Response time 1ms
 Delay before start-up ≤ 200ms

Electrical data

Operating voltage U_B 10 ... 30VDC (incl. residual ripple)
 Residual ripple ≤ 15% of U_B
 Bias current ≤ 50mA, ≤ 130mA with optional optics heating
 Switching output PNP transistor
 Function characteristics light/dark switching
 Signal voltage high/low ≥ ($U_B - 2V$) / ≤ 2V (PNP)
 Output current max. 100mA
 Sensitivity adjustable

Indicators

LED green ready
 LED yellow light path free
 LED yellow flashing light path free, no performance reserve

Mechanical data

Housing diecast zinc
 Optics cover glass
 Weight 380g
 Connection type terminals, M12 connector

Environmental data

Ambient temp. (operation/storage) -20°C ... +60°C / -40°C ... +70°C
 Protective circuit ³⁾ 1, 2, 3
 VDE safety class ⁴⁾ II, all-insulated
 Protection class IP 67, IP 69K ⁵⁾
 LED class 1 (acc. to EN 60825-1)
 Standards applied IEC 60947-5-2

Options

Activation input activ ≥ 8V / ≤ 2V (≥ 2V / ≤ 2V) ⁶⁾
 Transmitter active/not active ≤ 0.5ms
 Activation/disable delay 47KΩ ± 10%
 Input resistance PNP transistor, 100mA, counting principle
Warning output autoControl warn for temperature changes, prevents fogging
Optics heating to -35°C
Low temperature
Switching delay (slow oper./release) 0 ... 10s (separately adjustable)

- 1) Typ. operating range limit: max. attainable range without performance reserve
- 2) Operating range: recommended range with performance reserve
- 3) 1=transient protection, 2=polarity reversal protection, 3=short-circuit protection for all outputs
- 4) Rating voltage 250VAC
- 5) IP 69K test acc. to DIN 40050 part 9 simulated, high pressure cleaning conditions without the use of additives, acids and bases are not part of the test
- 6) Active high

Order guide

Selection table		Order code →			
Equipment ↓		LS 96M/P-3010-2 Part No. 500 25225 (Tr) Part No. 500 34128 (Re)	LS 96M/P-3010-4 Part No. 500 25228 (Tr) Part No. 500 34128 (Re)	LS 96M/P-3012-2 Part No. 500 25223 (Tr) Part No. 500 33328 (Re)	LS 96M/P-3012-4 Part No. 501 03290 (Tr) Part No. 501 03291 (Re)
Housing	metal	●	●	●	●
Light source	infrared light (120m)	●	●	●	●
Connection	terminals	●		●	
	M12 connector		●		●
Features	optics heating/low temp.			●	●
	activation input			● 6)	● 6)

Tables

0	120	150
---	-----	-----

□ Operating range [m]
 □ Typ. operating range limit [m]

Diagrams

Typ. response behaviour

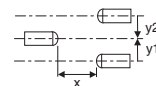
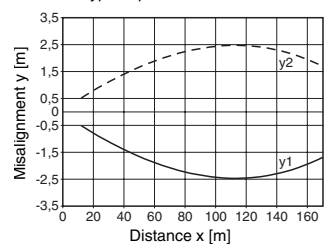

Remarks

LS = Pair consisting of
 LSS = Transmitter
 LSE = Receiver

LS 96M/P-3010-2
 LSS 96M-1070-23
 LSE 96M/P-3010-21

LS 96M/P-3010-4
 LSS 96M-1070-43
 LSE 96M/P-3010-41

LS 96M/P-3012-2
 LSS 96M-1090-24
 LSE 96M/P-3012-21

LS 96M/P-3012-4
 LSS 96M-1090-43
 LSE 96M/P-3012-41