



LS 96

Throughbeam photoelectric sensors



Dimensioned drawing

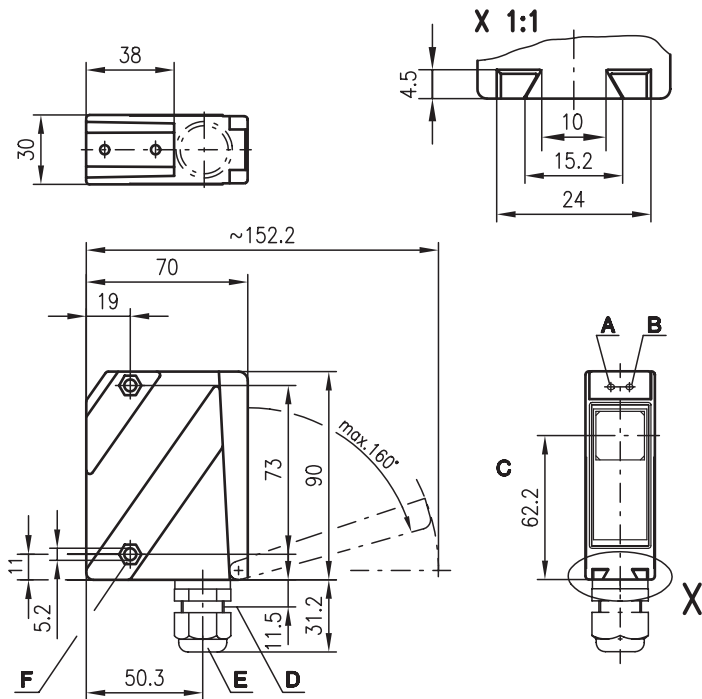

39m



- Powerful throughbeam photoelectric sensors with performance reserve in visible red light
- Wide angle version for easy alignment
- Robust metal housing with glass cover, protection class IP 67/IP 69K for industrial application
- Complementary outputs, sensitivity adjustment and delay before start-up for optimal adaptation to the application
- Connection via M12 connector or comfortable terminal compartment up to 1.5mm²

- A Indicator diode green
- B Indicator diode yellow
- C Optical axis
- D Device plug M12x1
- E Screwed cable gland M16x1.5 for Ø 5 ... 10mm
- F Countersinking for SK nut M5, 4.2 deep
- G Connection terminals
- H Cable entry
- I Sensitivity adjustment



Electrical connection

Transmitter

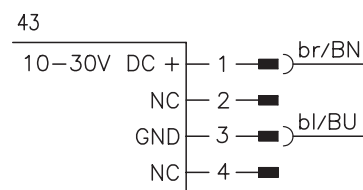
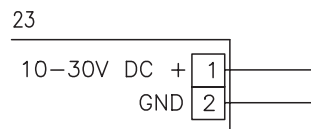

Receiver

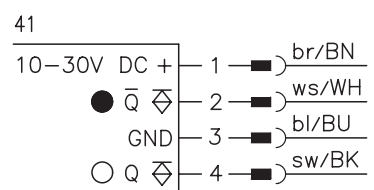
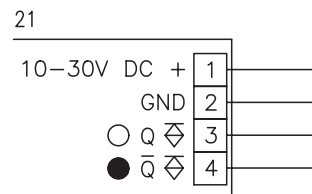

Accessories:

(available separately)

- Mounting systems (BT 96, BT 96.1, UMS 96, BT 450.1-96)
- M12 connectors (KD ...)
- Ready-made cables (K-D ...)
- Alignment aid ARH 96

We reserve the right to make changes • 96_a03e.fm

Specifications

Optical data

Typ. operating range limit ¹⁾
 Operating range ²⁾
 Light source
 Wavelength

Red light

0 ... 39m
 0 ... 30m
 LED (modulated light)
 660nm

Timing

Switching frequency
 Response time
 Delay before start-up

500Hz
 1ms
 ≤ 200ms

Electrical data

Operating voltage U_B
 Residual ripple
 Bias current
 Switching output
 Function characteristics
 Signal voltage high/low
 Output current
 Sensitivity

10 ... 30VDC (incl. residual ripple)
 ≤ 15% of U_B
 ≤ 50mA
 PNP transistor
 light/dark switching
 ≥ ($U_B - 2V$) / ≤ 2V (PNP)
 max. 100mA
 adjustable

Indicators

LED green
 LED yellow
 LED yellow flashing

ready
 light path free
 light path free, no performance reserve

Mechanical data

Housing
 Optics cover
 Weight
 Connection type

Metal housing

diecast zinc
 glass
 380g
 terminals, M12 connector

Environmental data

Ambient temp. (operation/storage)
 Protective circuit ³⁾
 VDE safety class ⁴⁾
 Protection class
 LED class
 Standards applied

-20°C ... +60°C / -40°C ... +70°C
 1, 2, 3
 II, all-insulated
 IP 67, IP 69K ⁵⁾
 1 (acc. to EN 60825-1)
 IEC 60947-5-2

- 1) Typ. operating range limit: max. attainable range without performance reserve
- 2) Operating range: recommended range with performance reserve
- 3) 1=transient protection, 2=polarity reversal protection, 3=short-circuit protection for all outputs
- 4) Rating voltage 250VAC
- 5) IP 69K test acc. to DIN 40050 part 9 simulated, high pressure cleaning conditions without the use of additives, acids and bases are not part of the test

Tables

0	30	39
---	----	----

- Operating range [m]
- Typ. operating range limit [m]

Diagrams

Typ. response behaviour

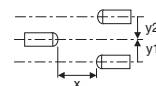
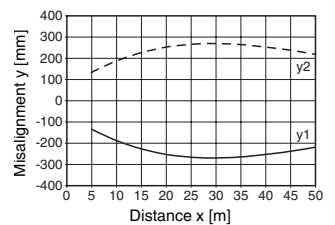

Remarks

- Angle at a distance of 3m:
transmitter:
 angle of radiation typ. 10°
receiver:
 receiving angle typ. 12°

LS = Pair consisting of
 LSS = Transmitter
 LSE = Receiver

LS 96M/P-181W-4
 LSS 96M-120W-43
 LSE 96M/P-181W-41

LS 96M/P-181W-2
 LSS 96M-120W-23
 LSE 96M/P-181W-21

LS 96M/P-1816-4
 LSS 96M-1206-43
 LSE 96M/P-1816-41

Order guide

Selection table		Order code →					
Equipment ↓		LS 96M/P-181W-4 Part No. 500 31574 (Tr) Part No. 500 31575 (Re)	LS 96M/P-181W-2 Part No. 500 32835 (Tr) Part No. 500 32741 (Re)	LS 96M/P-1816-4 Part No. 500 32129 (Tr) Part No. 500 32128 (Re)			
Housing	metal	●	●	●			
Light source	red light (30m)	●	●	●			
Connection	terminals		●				
	M12 connector	●		●			
Features	fixed sensitivity setting	●	●	●			
	optics heating/low temp.			●			