

RT 318

Energetic diffuse reflection light scanners

Part No. 501 08670



0 ... 250mm



- Energetic diffuse reflection light scanner with infrared light and straight optics
- Robust cylindrical metal or plastic housing M18x1, protection class IP 67 for industrial application
- Complementary switching outputs for light/dark switching or as a control function
- Very short construction for application in limited spaces

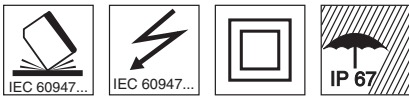

Accessories:

(available separately)

- Mounting systems (BT 318, BT 318-ARH)
- M12 connectors (KD ...)
- Ready-made cables (K-D ...)

Dimensioned drawing

RT 318M/...

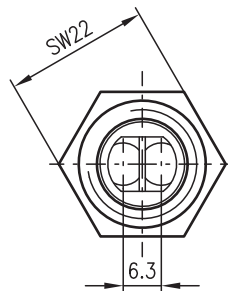
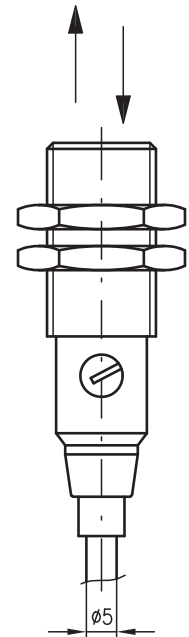
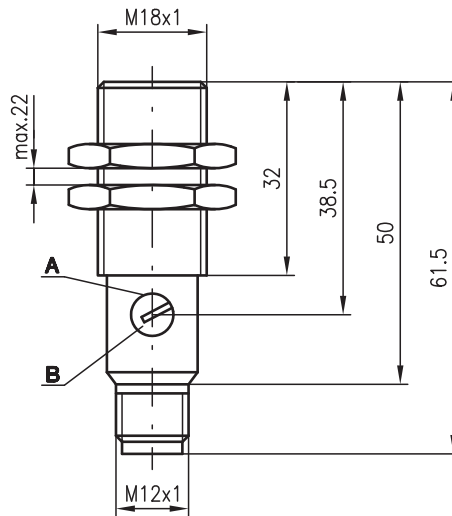

RT 318K/...

- A** Indicator diode
- B** Sensitivity adjustment

Electrical connection

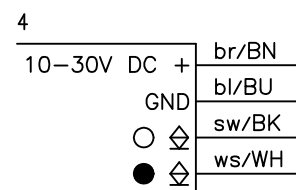
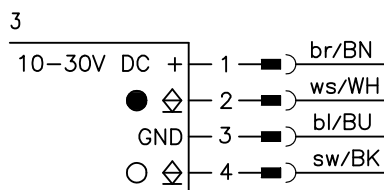
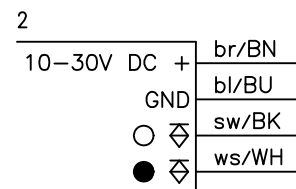
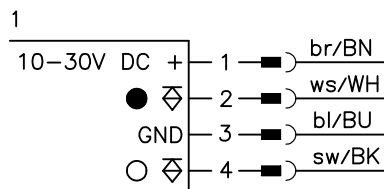

We reserve the right to make changes • 318_c04gb.fm

Specifications

Optical data

| | |
|---|-----------------------|
| Typ. scanning range limit (white 90%) ¹⁾ | 0 ... 250mm |
| Scanning range ²⁾ | see tables |
| Adjustment range | 80 ... 250mm |
| Light source | LED (modulated light) |
| Wavelength | 880nm |

Timing

| | |
|-----------------------|--------|
| Switching frequency | 1000Hz |
| Response time | 0.5ms |
| Delay before start-up | ≤ 30ms |

Electrical data

| | |
|--------------------------|-------------------------------------|
| Operating voltage U_B | 10 ... 30VDC |
| Residual ripple | ≤ 10% of U_B |
| Bias current | ≤ 15mA |
| Switching output | 2 transistor outputs, complementary |
| Function characteristics | light/dark switching |
| Signal voltage high/low | ≥ ($U_B - 1.6V$)/≤ 1.6V |
| Output current | max. 100mA |
| Sensitivity | adjustable |

Indicators

| | |
|------------------|------------------------------------|
| LED red | reflection |
| LED red flashing | reflection, no performance reserve |

Mechanical data

| | |
|-----------------|---|
| Housing | polyamide 12 or stainless steel |
| Optics cover | polyamide 12 |
| Weight | 90g (cable), 20g (M12) |
| Connection type | M12 connector, 4-pin cable 2m, 4x0.25mm ² |

Environmental data

| | |
|-----------------------------------|---------------------------------|
| Ambient temp. (operation/storage) | -25°C ... +65°C/-40°C ... +70°C |
| Protective circuit ³⁾ | 1, 2, 3, 4 |
| VDE safety class ⁴⁾ | II, all-insulated |
| Protection class | IP 67 |
| LED class | 1 (acc. to EN 60825-1) |
| Standards applied | IEC 60947-5-2 |

- 1) Typ. scanning range limit: max. attainable range without performance reserve
- 2) Scanning range: recommended range with performance reserve
- 3) 1=transient protection, 2=polarity reversal protection, 3=short circuit protection for all outputs, 4=interference blanking
- 4) Rating voltage 250VAC

Remarks

Approved purpose:

The diffuse reflection light scanners are optical electronic sensors for optical, contactless detection of objects.

- With the set scanning range, a tolerance of the upper and lower scanning range limit is possible depending on the reflection properties of the material surface.
- Models with NPN transistor output on request.

Order guide

| Selection table | | Order code → | | | | | | | |
|--------------------|-----------------|---|---|-------------------------------------|-------------------------------------|---|---|-------------------------------------|-------------------------------------|
| Equipment ↓ | | RT 318K/P-200-S12 Part No. 500 81355 | RT 318M/P-200-S12 Part No. 500 81357 | RT 318K/P-200 Part No. 500 81356 | RT 318M/P-200 Part No. 500 81358 | RT 318K/N-200-S12 Part No. 500 82148 | RT 318M/N-200-S12 Part No. 500 83102 | RT 318K/N-200 Part No. 500 83163 | RT 318M/N-200 Part No. 500 82050 |
| Housing | plastic | ● | | ● | | ● | | ● | |
| | stainless steel | | ● | | ● | | ● | | ● |
| Scanning range | 200mm | ● | ● | ● | ● | ● | ● | ● | ● |
| Connection | M12 connector | ● | ● | | | ● | ● | | |
| | cable | | | ● | ● | | | ● | ● |
| Switching output | PNP | ● | ● | ● | ● | | | ● | |
| | NPN | | | | | ● | ● | ● | ● |
| Connection diagram | | 1 | 1 | 2 | 2 | 3 | 3 | 4 | 4 |

Tables

RT 318...-200-...

| | | | |
|---|---|-----|-----|
| 1 | 0 | 200 | 250 |
| 2 | 2 | 100 | 120 |
| 3 | 7 | 70 | 80 |

| | |
|---|-----------|
| 1 | white 90% |
| 2 | grey 18% |
| 3 | black 6% |

| | |
|---|--------------------------------|
| □ | Scanning range [mm] |
| ■ | Typ. scanning range limit [mm] |

Diagrams

RT 318...-200-...

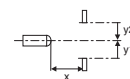
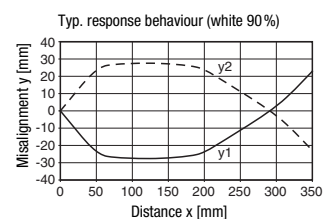

RT 318...-200-...

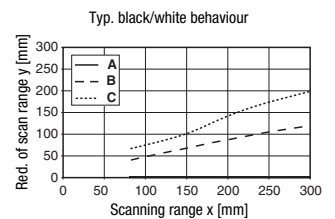

- A white 90%
- B grey 18%
- C black 6%

