

DDLS 200

Bus-Capable Optical Data Transmission

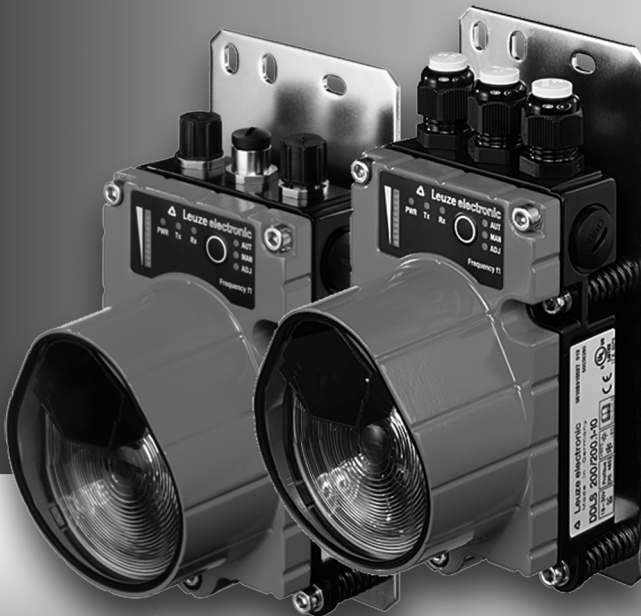

Sales and Service

Germany

Sales Region North

Phone 07021/573-306
 Fax 07021/9850950

Postal code areas
 20000-38999
 40000-65999
 97000-97999

Sales Region South

Phone 07021/573-307
 Fax 07021/9850911

Postal code areas
 66000-96999

Sales Region East

Phone 035027/629-106
 Fax 035027/629-107

Postal code areas
 01000-19999
 39000-39999
 98000-99999

Worldwide

AR (Argentina)

Condelectric S.A.
 Tel. Int. + 54 1148 361053
 Fax Int. + 54 1148 361053

AT (Austria)

Schmachtl GmbH
 Tel. Int. + 43 732 7646-0
 Fax Int. + 43 732 7646-785

AU + NZ (Australia + New Zealand)

Balluff/Leuze Pty. Ltd.
 Tel. Int. + 61 3 9720 4100
 Fax Int. + 61 3 9738 2677

BE (Belgium)

Leuze electronic nv/sa
 Tel. Int. + 32 2253 16-00
 Fax Int. + 32 2253 15-36

BG (Bulgaria)

ATICS
 Tel. Int. + 359 2 847 6244
 Fax Int. + 359 2 847 6244

BR (Brasil)

Leuze electronic Ltda.
 Tel. Int. + 55 11 5180-6130
 Fax Int. + 55 11 5180-6141

CH (Switzerland)

Leuze electronic AG
 Tel. Int. + 41 71 784 5656
 Fax Int. + 41 71 784 5657

CL (Chile)

Imp. Tec. Vignola S.A.I.C.
 Tel. Int. + 56 3235 11-11
 Fax Int. + 56 3235 11-28

CN (China)

Leuze electronic Trading
 (Shenzhen) Co. Ltd.
 Tel. Int. + 86 755 862 64909
 Fax Int. + 86 755 862 64901

CO (Colombia)

Componentes Electronicas Ltda.
 Tel. Int. + 57 4 3511049
 Fax Int. + 57 4 3511019

CZ (Czech Republic)

Schmachtl CZ s.r.o.
 Tel. Int. + 420 244 0015-00
 Fax Int. + 420 244 9107-00

DK (Denmark)

Leuze electronic Scandinavia ApS
 Tel. Int. + 45 48 173200

ES (Spain)

Leuze electronic S.A.
 Tel. Int. + 34 93 4097900
 Fax Int. + 34 93 49305820

FI (Finland)

SKS-automaatio Oy
 Tel. Int. + 358 20 764-61
 Fax Int. + 358 20 764-6820

FR (France)

Leuze electronic Sarl.
 Tel. Int. + 33 160 0512-20
 Fax Int. + 33 160 0503-65

GB (United Kingdom)

Leuze electronic Ltd.
 Tel. Int. + 44 14 8040 85-00
 Fax Int. + 44 14 8040 38-08

GR (Greece)

UTEKO A.B.E.E.
 Tel. Int. + 30 211 1206 900
 Fax Int. + 30 211 1206 999

HK (Hong Kong)

Sensortech Company
 Tel. Int. + 852 26510188
 Fax Int. + 852 26510388

HR (Croatia)

Tipteh Zagreb d.o.o.
 Tel. Int. + 385 1 381 6574
 Fax Int. + 385 1 381 6577

HU (Hungary)

Kvaik Automatika Kft.
 Tel. Int. + 36 1 272 2242
 Fax Int. + 36 1 272 2244

ID (Indonesia)

P.T. Yabestindo Mitra Utama
 Tel. Int. + 62 21 92861859
 Fax Int. + 62 21 6451044

IL (Israel)

Galoz electronics Ltd.
 Tel. Int. + 972 3 9023456
 Fax Int. + 972 3 9021990

IN (India)

M + V Marketing Sales Pvt Ltd.
 Tel. Int. + 91 124 4121623
 Fax Int. + 91 124 434293

IT (Italy)

Leuze electronic S.r.l.
 Tel. Int. + 39 02 26 1106-43
 Fax Int. + 39 02 26 1106-40

JP (Japan)

C. Illies & Co., Ltd.
 Tel. Int. + 81 3 3443 4143
 Fax Int. + 81 3 3443 4118

KE (Kenia)

Profa-Tech Ltd.
 Tel. Int. + 254 20 828095/6
 Fax Int. + 254 20 828129

KR (South Korea)

Leuze electronic Co., Ltd.
 Tel. Int. + 82 31 3828228
 Fax Int. + 82 31 3828252

MK (Macedonia)

Tipteh d.o.o. Skopje
 Tel. Int. + 389 70 399 474
 Fax Int. + 389 23 174 197

MX (Mexico)

Movitren S.A.
 Tel. Int. + 52 81 8371 8616
 Fax Int. + 52 81 8371 8588

MY (Malaysia)

Ingermark (M) SDN.BHD
 Tel. Int. + 60 360 3427-88
 Fax Int. + 60 360 3421-88

NG (Nigeria)

SABROW HI-TECH E. & A. LTD.
 Tel. Int. + 234 80333 86366
 Fax Int. + 234 80333 84463518

NL (Netherlands)

Leuze electronic BV
 Tel. Int. + 31 418 65 35-44
 Fax Int. + 31 418 65 39-08

NO (Norway)

Elteco A/S
 Tel. Int. + 47 35 56 20-70
 Fax Int. + 47 35 56 20-99

PL (Poland)

Balluff Sp. z o.o.
 Tel. Int. + 48 71 338 49 29
 Fax Int. + 48 71 338 49 30

PT (Portugal)

LA2P, Lda.
 Tel. Int. + 351 21 4 447070
 Fax Int. + 351 21 4 447075

RO (Romania)

O BOYLE s.r.l.
 Tel. Int. + 40 2 56201346
 Fax Int. + 40 2 56221036

RS (Republic of Serbia)

Tipteh d.o.o. Beograd
 Tel. Int. + 381 11 3131 057
 Fax Int. + 381 11 3018 326

RU (Russian Federation)

ALL IMPEX 2001
 Tel. Int. + 7 495 9213012
 Fax Int. + 7 495 6462092

SE (Sweden)

Leuze electronic Scandinavia ApS
 Tel. Int. + 45 48 173200

SG + PH (Singapore + Philippines)

Balluff Asia Pte Ltd
 Tel. Int. + 65 6252 43-84
 Fax Int. + 65 6252 90-60

SI (Slovenia)

Tipteh d.o.o.
 Tel. Int. + 386 1200 51-50
 Fax Int. + 386 1200 51-51

SK (Slovakia)

Schmachtl SK s.r.o.
 Tel. Int. + 421 2 58275600
 Fax Int. + 421 2 58275601

TH (Thailand)

Industrial Electrical Co. Ltd.
 Tel. Int. + 66 2 642 6700
 Fax Int. + 66 2 642 4250

TR (Turkey)

Leuze electronic San.ve Tic.Ltd.Siti.
 Tel. Int. + 90 216 456 6704
 Fax Int. + 90 216 456 6706

TW (Taiwan)

Great Colue Technology Co., Ltd.
 Tel. Int. + 886 2 2983 60-77
 Fax Int. + 886 2 2985 33-73

UA (Ukraine)

SV Altera OOO
 Tel. Int. + 38 044 4961888
 Fax Int. + 38 044 4961818

US + CA (United States + Canada)

Leuze electronic, Inc.
 Tel. Int. + 1 248 486-4466
 Fax Int. + 1 248 486-6699

ZA (South Africa)

Countapulse Controls (PTY) Ltd.
 Tel. Int. + 27 116 1575-56
 Fax Int. + 27 116 1575-13

1	General Information	4
1.1	Explanation of symbols	4
1.2	Declaration of conformity	4
1.3	Short description	4
1.4	Operating principle	5
2	Safety Notices	6
2.1	Safety standards	6
2.2	Intended use	6
2.3	Working safely	6
2.4	Organizational measures	7
3	Technical Data	8
3.1	General technical data	8
3.2	Dimensioned drawings.....	10
4	Mounting / Installation (all device models)	11
4.1	Mounting and alignment.....	11
4.2	Arrangement of adjacent transmission systems	12
4.3	Cascading (series connection) of several DDLS 200 data paths.....	14
4.4	Electrical connection	16
4.4.1	Electrical connection - devices with screwed cable glands and terminals.....	16
4.4.2	Electrical connection - devices with M12 connectors	19
5	PROFIBUS / RS 485	21
5.1	PROFIBUS connection - devices with screwed cable glands and terminals	21
5.1.1	Converting the PROFIBUS model with terminals to M12 connectors	22
5.2	PROFIBUS connection - devices with M12 connectors.....	23
5.3	Device configuration PROFIBUS	24
5.4	LED Indicators PROFIBUS	25
6	INTERBUS 500kbit/s / RS 422	26
6.1	Electrical connection INTERBUS 500kbit/s	26
6.2	Device configuration INTERBUS 500kbit/s / RS 422.....	27
6.3	LED indicators INTERBUS 500kbit/s / RS 422.....	28
7	INTERBUS 2Mbit/s Fiber-Optic Cable	29
7.1	Fiber-optic-cable connection INTERBUS 2Mbit/s.....	29
7.2	Device configuration INTERBUS 2Mbit/s FOC.....	30
7.3	LED indicators INTERBUS 2Mbit/s fiber-optic cable	31

8	Data Highway + (DH+) / Remote I/O (RIO).....	32
8.1	Electrical connection DH+ / RIO	32
8.2	Device configuration DH+ / RIO.....	33
8.3	LED indicators DH+ / RIO	34
9	DeviceNet / CANopen	35
9.1	Electrical connection DeviceNet / CANopen - screwed cable glands/terminals	35
9.1.1	Bus transceiver and device supplied via separate power connection	36
9.1.2	Bus transceiver supplied via bus cable, device supplied via separate power line	36
9.1.3	Bus transceiver and device supplied via bus cable.....	37
9.1.4	Installation and connection of the optional M12 connectors	38
9.2	DeviceNet/CANopen electrical connection- M 12 connectors	39
9.3	Device configuration DeviceNet / CANopen	41
9.3.1	Baud rate conversion	41
9.3.2	Sorting (switch S4.1)	41
9.3.3	Bus lengths as a function of the baud rate.....	41
9.4	Wiring.....	42
9.4.1	Termination	43
9.5	DeviceNet/CANopen LED indicators	44
9.6	Interruption of the data transmission path.....	45
9.7	Important notices for system integrators.....	46
9.7.1	Schematic drawing of the inner construction.....	47
9.7.2	Timing	48
9.7.3	Synchronous messages.....	49
9.7.4	Other implementation notes	49
10	Ethernet	50
10.1	Ethernet connection - devices with screwed cable glands and terminals	50
10.2	Ethernet connection - devices with M12 connectors	51
10.3	Device configuration Ethernet.....	52
10.3.1	Autonegotiation (Nway).....	52
10.3.2	Transmission rate conversion	52
10.3.3	Network expansion.....	52
10.4	Wiring.....	53
10.4.1	Assignment of the RJ45 and M12 Ethernet cables.....	54
10.4.2	Installing cable with RJ45 connector	55
10.5	LED Indicators Ethernet.....	56
10.6	Important notices for system integrators.....	56
10.6.1	Typical bus configuration	57
10.6.2	Timing	58

11	Commissioning / Operation (all device models)	60
11.1	Indicator and operating elements.....	60
11.2	Operating modes	61
11.3	Initial commissioning	62
11.3.1	Switch on device / function check.....	62
11.3.2	Fine adjustment	62
11.4	Operation	63
12	Maintenance	64
12.1	Cleaning.....	64
13	Diagnostics and Troubleshooting	65
13.1	Status display on the device	65
13.2	Diagnostic mode	65
13.3	Troubleshooting	66
14	Accessories	67
14.1	Accessory terminating resistors	67
14.2	Accessory connectors.....	67
14.3	Accessory ready-made cables for voltage supply.....	67
14.3.1	Contact assignment of PWR IN connection cable for voltage supply.....	67
14.3.2	Technical data of PWR IN connection cable for voltage supply	67
14.3.3	Order codes of PWR IN connection cable for voltage supply.....	67
14.4	Accessory ready-made cables for interface connection.....	68
14.4.1	General	68
14.4.2	Contact assignment for PROFIBUS connection cable KB PB.....	68
14.4.3	Technical data for PROFIBUS connection cable KB PB.....	69
14.4.4	Order codes for M12 PROFIBUS connection cables KB PB.....	69
14.4.5	Contact assignment for M12 Ethernet connection cable KB ET.....	70
14.4.6	Technical data for M12 Ethernet connection cable KB ET.....	70
14.4.7	Order codes for M12 Ethernet connection cables KB ET.....	71

1 General Information

1.1 Explanation of symbols

The symbols used in this operating manual are explained below.

**Attention!**

Pay attention to passages marked with this symbol. Failure to heed this information can lead to injuries to personnel or damage to the equipment.

**Attention Laser!**

This symbol warns of possible danger through hazardous laser radiation.

**Note!**

This symbol indicates text passages containing important information.

1.2 Declaration of conformity

The optical DDLS 200 data transmission system was designed and manufactured in accordance with applicable European normatives and guidelines.

The manufacturer of the product, Leuze electronic GmbH + Co KG in D-73277 Owen/Teck, possesses a certified quality assurance system in accordance with ISO 9001.

The declaration of conformity can be requested from the manufacturer.



1.3 Short description

Where data have to be transmitted to and from moving objects, optical data transmission systems provide an ideal solution.

With the DDLS 200 Series, Leuze electronic offers optical, high-performance data transmission systems. The data transmission units are robust and are not subject to wear.

A DDLS 200 data transmission system consists of a set of two transmission and reception units: e.g. DDLS 200/200.1-10 and DDLS 200/200.2-10.

Features of the DDLS 200

The fact that bus systems are found in nearly all areas of industry places high demands on data transmission systems. The DDLS 200 fulfills these requirements, particularly with regard to:

- Transmission safety
- Minimum transmission times (real-time capable)
- Deterministic transmission

The DDLS 200 data transmission system, which is available in several model variations, makes possible the contact-free transmission of the following bus protocols:

- PROFIBUS FMS, DP, MPI, FMS - DP mixed-operation, up to max. 1.5Mbit/s, PROFISAFE
- INTERBUS 500kbit/s, RS 422 general, copper cable
- INTERBUS 2Mbit/s / 500kbit/s, fiber-optic cable
- Data Highway + (DH+) from Rockwell Automation (Allen Bradley)
- Remote I/O (RIO) from Rockwell Automation (Allen Bradley)
- DeviceNet
- CANopen
- Ethernet for all protocols based on TCP/IP or UDP

Other bus systems on request.

1.4 Operating principle

To prevent the devices from mutually interfering with one another during data transmission in duplex operation, they use two different frequency pairs. These are indicated by the type designation1 and2 as well as the label **frequency f₁** and **frequency f₂** on the control panel.

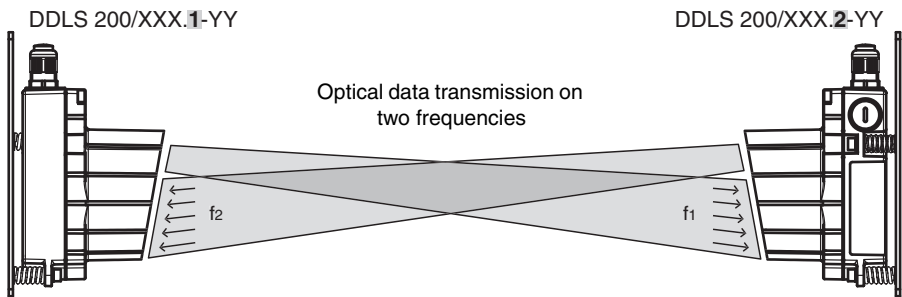

Figure 1.1: Operating principle

The receiving level is checked at both devices and can be read on a bar graph LED indicator. If the receiving level drops below a certain value, e.g. due to increased soiling of the optics, a warning output is activated.

All work on the device (mounting, connecting, aligning, indicator/operating elements) is performed comfortably on the front side.

2 Safety Notices

2.1 Safety standards

The optical DDLS 200 data transmission system was developed, manufactured and tested in accordance with applicable safety standards. It corresponds to the state of the art. The device series DDLS 200 is "UL LISTED" according to U.S. American and Canadian safety standards, and fulfills the requirements of Underwriter Laboratories Inc. (UL).

2.2 Intended use

The DDLS 200 optical data transmission system has been designed and developed for the optical transmission of data in the infrared range.

**Attention!**

The protection of personnel and the device cannot be guaranteed if the device is operated in a manner not corresponding to its intended use.

Areas of application

The DDLS 200 is suitable for the following areas of application:

- Automated high-bay warehouses
- Stationary data transmission between buildings
- Anywhere, where data transmission to and from stationary or moving objects (visual contact) over relatively long distances (up to 500m) is required.
- Rotary transmission

2.3 Working safely

**Attention: Artificial optical radiation!**

The DDLS 200 data transmission system uses an infrared diode and is a device of LED Class 1 according to EN 60825-1.

When used under reasonable conditions, devices of LED Class 1 are safe. This even includes the use of optical instruments used for the direct observation of the laser beam.

For the operation of the data transmission system with artificial optical radiation, we refer to directive 2006/25/EC or its implementation in the respective national legislation and to the applicable parts of EN 60825.

**Attention!**

Interventions and changes to the device, except where expressly described in this operating manual, are not authorized.

2.4 Organizational measures

Documentation

All entries in this operating manual must be heeded, in particular those in the sections "Safety Notices" and "Commissioning". Keep this technical description in a safe place. It should be accessible at all times.

Safety regulations

Observe the locally applicable legal regulations and the rules of the employers' liability insurance association.

Qualified personnel

Mounting, commissioning and maintenance of the device may only be carried out by qualified personnel.

Work on electrical installations may only be carried out by qualified electricians.

Repair

Repairs must only be carried out by the manufacturer or an authorized representative.

3 Technical Data

3.1 General technical data

Electrical data	
Supply voltage V_{in}	18 ... 30VDC
Current consumption without optics heating	approx. 200mA with 24VDC (no load at switching output)
Current consumption with optics heating	approx. 800mA with 24VDC (no load at switching output)
Optical data	
Sensing distance	0.2 ... 30m (DDLS 200/30...) 0.2 ... 80m (DDLS 200/80...) 0.2 ... 120m (DDLS 200/120...) 0.2 ... 200m (DDLS 200/200...) 0.2 ... 300m (DDLS 200/300...) 0.2 ... 500m (DDLS 200/500...)
Transmission diode	infrared light, wavelength 880nm
Opening angle	$\pm 0.5^\circ$ with respect to the optical axis for 120m ... 500m models, $\pm 1.0^\circ$ with respect to the optical axis for 80m models, $\pm 1.5^\circ$ with respect to the optical axis for 30m models
Ambient light	> 10000 Lux according to EN 60947-5-2:2008
LED class	1 acc. to EN 60825-1
Input/output	
Input	0 ... 2VDC: transmitter/receiver deactivated 18 ... 30VDC: transmitter/receiver activated
Output	0 ... 2VDC: normal operation $V_{in} - 2VDC$: limited performance reserve output current max. 100mA, short-circuit proof, protected against surge voltage, transients and overheating
Operating and display elements	
Membrane buttons	change the operating mode
Individual LEDs	indicate voltage supply, operating mode, data traffic (depends on the model)
LED strip	bar graph display of the receiving level
Mechanical data	
Housing	aluminum diecast; light inlet/outlet, glass
Weight	approx. 1200g
Protection class	IP 65 acc. to EN 60529:2000

Environmental conditions	
Operating temperature	-5 °C ... +50 °C without optics heating -30 °C ... +50 °C with optics heating (non-condensing)
Storage temperature	-30 °C ... +70 °C
Air humidity	max. 90% rel. humidity, non-condensing
Vibrations	acc. to EN 60068-2-6:1996
Noise	acc. to EN 60068-2-64:2009
Shock	acc. to EN 60068-2-27:1995 and EN 60068-2-29:1995
EMC ^{*1}	EN 61000-6-2:2006 and EN 61000-6-4:2007
UL LISTED	acc. to UL 60950 and CSA C22.2 No. 60950

*1 **Warning:** This is a Class A product. In a domestic environment this product may cause radio interference, in which case the operator may be required to take adequate measures.

3.2 Dimensioned drawings

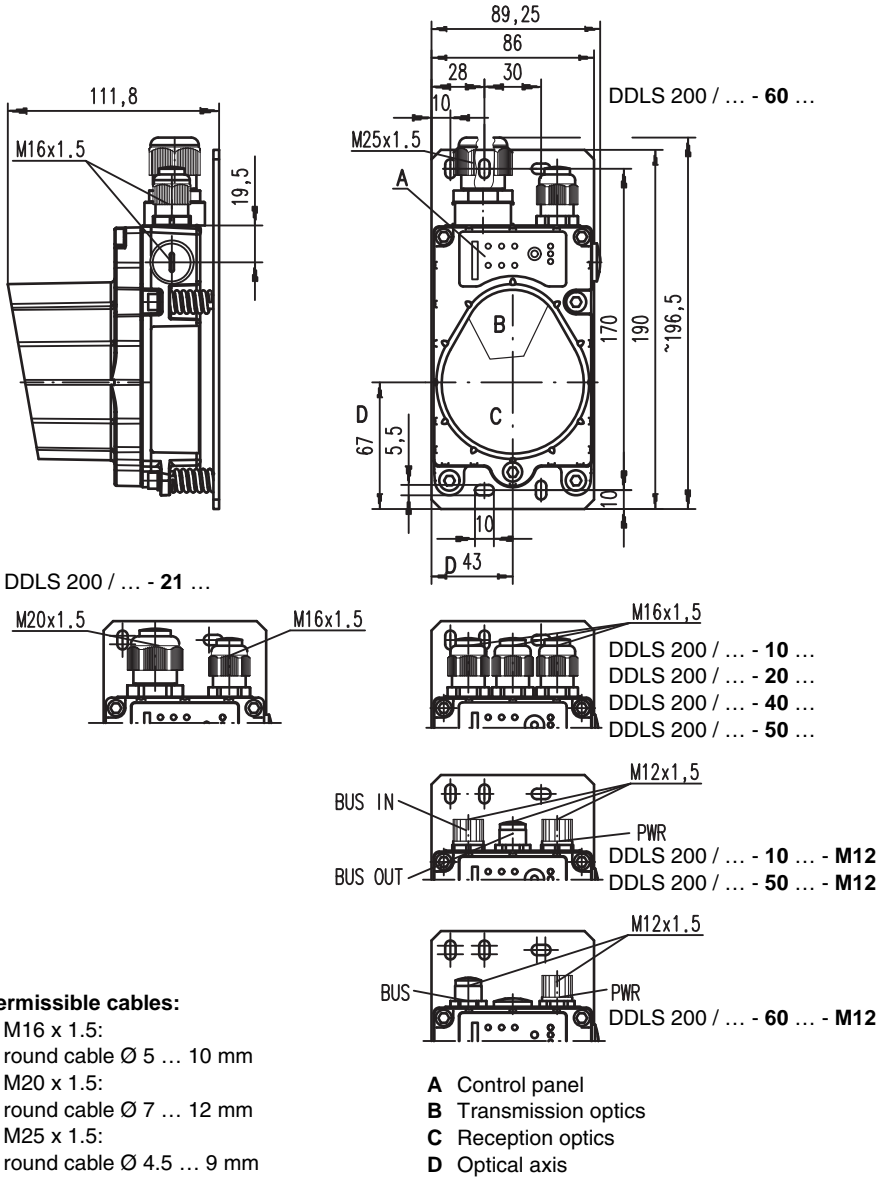

Figure 3.1: Dimensioned drawing DDLS 200

4 Mounting / Installation (all device models)

4.1 Mounting and alignment

An optical data transmission system, consisting of 2 DDLS 200 devices, involves mounting each of the devices on mutually opposing, plane-parallel, flat and usually vertical walls with unobstructed view of the opposing DDLS 200.

Make certain that, at the minimum operating distance A_{\min} the optical axes of the devices are aligned with one another within $\pm A_{\min} \cdot 0.01$ to ensure that the transmission/reception beams of the two devices lie within the opening angle. This also applies for rotary transmission.



Note

The opening angle (angle of radiation) of the optics is $\pm 0.5^\circ$ (wide angle: $\pm 1.0^\circ$ or $\pm 1.5^\circ$, resp.) to the optical axis! For all device models, the horizontal and vertical adjustment angles of the fine alignment with the adjustment screws is $\pm 6^\circ$ for each. The optical transmission path between the DDLS 200s should not be interrupted. If interruptions cannot be avoided, be sure to read the notice in chapter 11.4.

Therefore, pay close attention when selecting a suitable mounting location!



Attention!

When laying out a mobile arrangement for a DDLS 200, pay particular attention that the alignment of the devices relative to one another remains unchanged over the transmission path. The transmission can be interrupted by e.g. jolts, vibrations or inclination of the mobile device due to irregularities in the floor or path.

Ensure adequate track stability! (see also "Diagnostic mode" on page 65)

Mount each device with 4 screws $\varnothing 5\text{mm}$ using 4 of the 5 fastening holes in the mounting plate of the device (see chapter 3.2 "Dimensioned drawings").

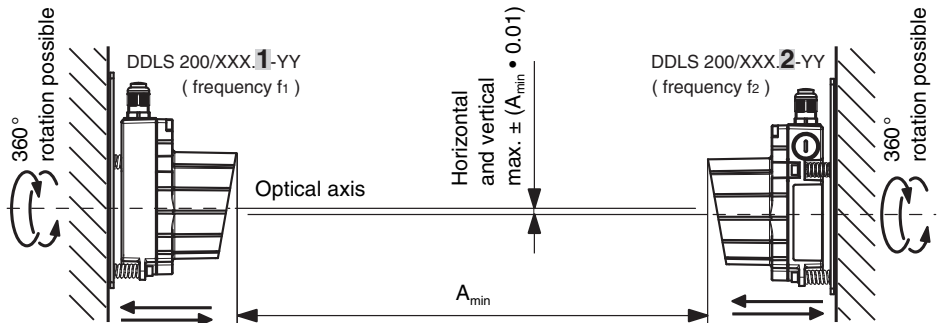

Figure 4.1: Mounting the devices



Note

The fine alignment of the transmission system is performed during commissioning (see chapter 11.3.2 "Fine adjustment"). The position of the optical axis of the DDLS 200 can be found in chapter 3.2.

4.2 Arrangement of adjacent transmission systems

To prevent mutual interference of adjacent transmission systems, the following measures should be taken in addition to exact alignment:

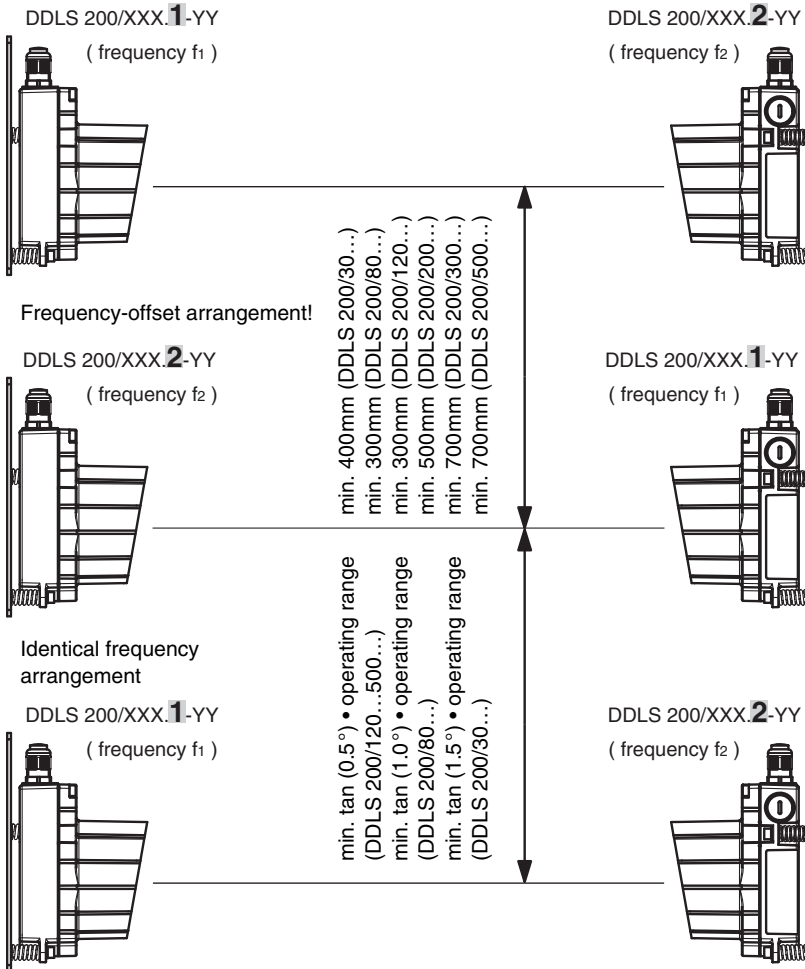

Figure 4.2: Arrangement of adjacent transmission systems

- In the case of an **offset frequency arrangement**, the **distance between two parallel** data transmission paths must not be less than
 - **400mm** (DDLS 200/30...)
 - **300mm** (DDLS 200/80...)
 - **300mm** (DDLS 200/120...)
 - **500mm** (DDLS 200/200...)
 - **700mm** (DDLS 200/300...)
 - **700mm** (DDLS 200/500...)

- In the case of **identical frequency arrangement**, the **distance between two parallel** data transmission paths must be at least
 - **400mm + tan (1.5°) • operating range** (DDLS 200/30...)
 - **300mm + tan (1.0°) • operating range** (DDLS 200/80...)
 - **300mm + tan (0.5°) • operating range** (DDLS 200/120...)
 - **500mm + tan (0.5°) • operating range** (DDLS 200/200...)
 - **700mm + tan (0.5°) • operating range** (DDLS 200/300...)
 - **700mm + tan (0.5°) • operating range** (DDLS 200/500...)

4.3 Cascading (series connection) of several DDLS 200 data paths

If two communicating participants (TN) are separated by several optical transmission paths between two participants, then this is called cascading. There are further participants between the individual optical transmission paths in this case.

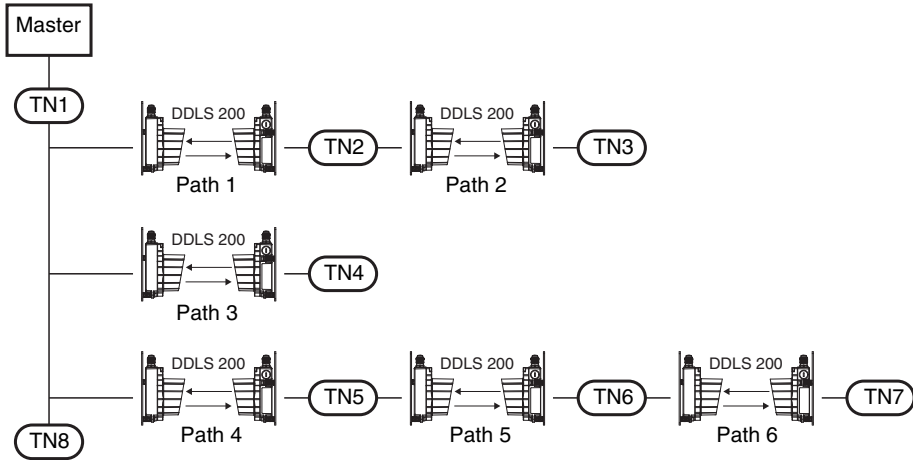

Figure 4.3: Cascading of several DDLS 200 systems



Attention!

If, for example, participant 3 (TN3) of a multi-master bus system wants to exchange data directly with participant 7 (TN7), then 5 optical transmission paths are cascaded.

This constellation can also occur if, e.g., a programming device that attempts to access participant 3 (TN3) is connected to participant 7 (TN7) for maintenance purposes or during commissioning of a master-slave-system.

The following table shows the maximum number of optical transmission paths for cascading.

Bus system	Max. number of optical transmission paths for cascading	Remark
Profibus (with retiming)	3	Attention: Profibus FMS is a multi-master bus
RS 485 (without retiming)	2	
Interbus 500kbit (RS 422)	3	
Interbus FOC	3	Applies for 500kbit and 2Mbit
RIO	3 ¹⁾	
DH+	3 ¹⁾	Attention: DH+ may be a multi-master bus
DeviceNet	3	Depends significantly on the configuration of the master and on the requirements of the plant (timing).
CANopen	3	
Ethernet	3	

1) See remarks in the respective chapters of the individual bus systems about the switch position filtered/not filtered depending on the transmission rate.



Note

The individual time delay of the optical transmission path is specified in the chapters of the individual bus systems and depends on the type, switch position, and transmission rate.

4.4 Electrical connection



Attention!

Connection of the device and maintenance work while under voltage must only be carried out by a qualified electrician.

If faults cannot be corrected, the device should be removed from operation and protected against possible use.

Before connecting the device, be sure that the supply voltage agrees with the value printed on the nameplate.

The DDLS 200... is designed in accordance with safety class III for supply by PELV (Protective Extra Low Voltage, with reliable disconnection).

For UL applications: only for use in class 2 circuits according to NEC.

Be sure that the functional earth is connected correctly. Error-free operation is only guaranteed if the device is connected to functional earth.

Described in the following two sub-chapters is the electrical connection of the supply voltage, the input and the output.

The connection of the respective bus system is described in the following chapters.

4.4.1 Electrical connection - devices with screwed cable glands and terminals

To establish the electrical connections, you must first remove the red housing top with the optics. To do this, loosen the three housing hex screws. The housing top is now only electrically connected to the base by means of a connector. Carefully pull the housing top straight forward without skewing.

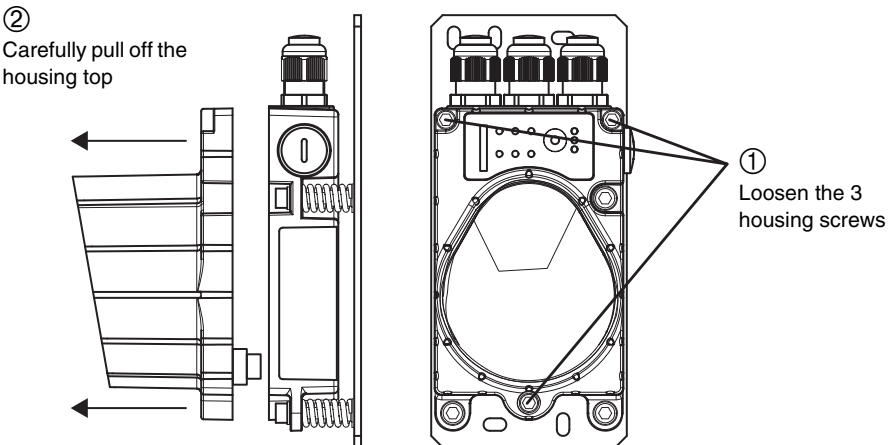
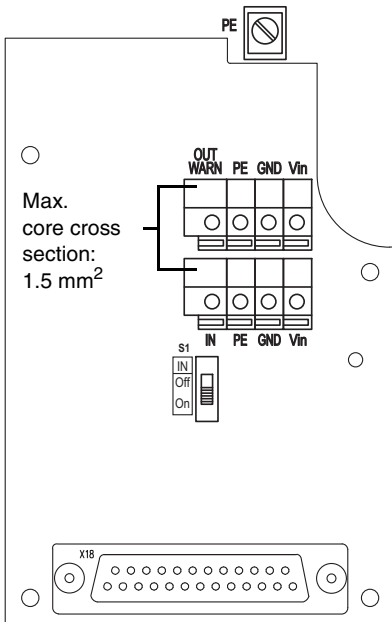

Figure 4.4: Removing the housing top

The connection compartment in the housing base with the screwed cable glands is now freely accessible.



Terminal	Function
Vin	Positive supply voltage +18 ... +30VDC
GND	Negative supply voltage 0VDC
PE	Functional earth
OUT WARN	Switching output , activated if level drops below the warning level
IN	Switching input for transmitter/receiver cut-off: 0 ... 2 V DC : transmitter/receiver switched off, no transmission 18 ... 30 V DC : transmitter/receiver active, normal function
Switch	Function
S1	On (default) : the switching input is not analyzed. The transmitter/receiver unit is always in operation. Off : the switching input is analyzed. Depending on the input voltage, normal function or transmitter/receiver unit switched off.

Figure 4.5: Positions of the general, non-bus-specific terminals and switches

Supply voltage

Connect the supply voltage, including the functional earth, to the spring terminals labeled **Vin**, **GND** and **PE** (see figure 4.5).



Note

The connection terminals **Vin**, **GND** and **PE** are provided double to simplify wiring through the supply voltage to other devices.

The functional earth can alternatively be connected at the screw terminal in the housing base (max. core cross section 2.5mm²)

If you would like to wire through the supply voltage, you should replace the filler plugs on the right side of the housing base with an M16 x 1.5 screwed cable gland and guide the continuing supply voltage cable through this gland. The housing seal is, in this way, ensured (Protection Class IP 65).

The housing top can be removed and replaced while under voltage.

Switching input

The DDLS 200 is equipped with a switching input **IN**, via which the transmitter/receiver unit can be switched off, i.e. no infrared light is transmitted and at the bus terminals the corresponding bus bias level is present / the bus driver is high resistance.

Input voltage: 0 ... 2 V DC: transmitter/receiver switched off, no transmission
(relative to GND) 18 ... 30 V DC: transmitter/receiver active, normal function

For easier operation, the switching input can be activated/deactivated via switch S1:

Position S1: **On** the switching input is not analyzed. The transmitter/receiver unit is always in operation (internal preselection of the switching input with Vin).

Off the switching input is analyzed. Depending on the input voltage, normal function or transmitter/receiver unit switched off.



Note!

When transmitter/receiver unit is switched off, the system behaves in the same way as in the event of a light beam interruption (see chapter 11.4 "Operation").

The switching input can be used, for example, during a corridor change to completely avoid interference effects from other sensors or the data transmission.

Switch S1 is also present on the device models with M12 connectors.

Switching output

The DDLS 200 is equipped with a switching output **OUT WARN** which is activated if the receiving level in the receiver drops.

Output voltage: 0 ... 2 V DC: Operating range
(relative to GND) Vin - 2 V DC: Warning or shutoff range

The switching output is protected against: short-circuit, overcurrent, overvoltage, overheating and transients.



Note!

The DDLS 200 is still completely functional when the level of the receiving signal drops to the warning signal level. Checking the alignment, and, if applicable, a readjustment and/or cleaning of the glass pane leads to a significant improvement of the received signal level.

4.4.2 Electrical connection - devices with M12 connectors

The electrical connection is easily performed using M12 connectors. Ready-made connection cables are available as accessories both for connecting supply voltage/switching input/switching output as well as for connecting the respective bus system (see chapter 14 "Accessories").

For all M12 device models, the supply voltage, the switching input and the switching output are connected via the right, A-coded connector **PWR IN** (see figure 4.6).

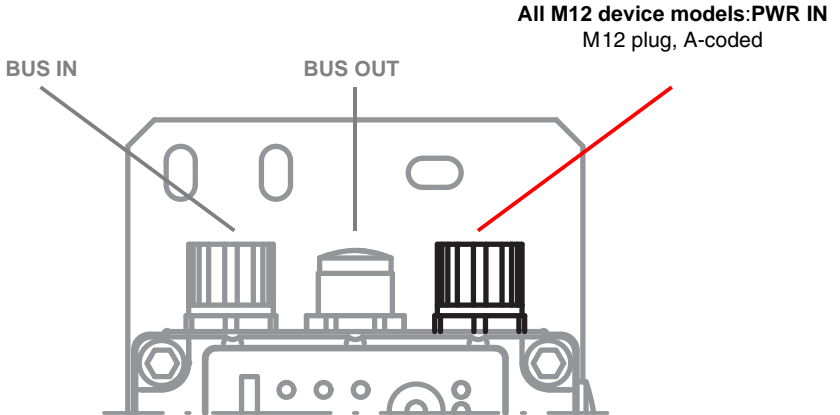

Figure 4.6: Location and designation of the M12 connections

PWR IN (5-pin M12 plug, A-coded)			
	Pin	Name	Remark
<p>PWR IN OUT WARN 2 1 Vin 3 GND 4 IN FE M12 plug (A-coded)</p>	1	Vin	Positive supply voltage +18 ... +30VDC
	2	OUT WARN	Switching output , activated if level drops below the warning level
	3	GND	Negative supply voltage 0VDC
	4	IN	Switching input for transmitter/receiver cut-off: 0 ... 2 V DC: transmitter/receiver switched off, no transmission 18 ... 30 V DC: transmitter/receiver active, normal function
	5	FE	Functional earth
	Thread	FE	Functional earth (housing)

Figure 4.7: Assignment M12 connector PWR IN

Supply voltage

Connect the supply voltage including functional earth according to the pin assignments (see figure 4.7).

Switching input

The DDLS 200 is equipped with a switching input **IN** (pin 1), via which the transmitter/receiver unit can be switched off, i.e. no infrared light is transmitted and at the bus terminals the corresponding bus bias level is present / the bus driver is high resistance.

The upper part of the housing only needs to be removed if the switching input is to be activated/deactivated via switch S1 (for further information, see figure 4.4, figure 4.5 and "Switching input" on page 18).

Input voltage: 0 ... 2 V DC: transmitter/receiver switched off, no transmission
(relative to GND) 18 ... 30 V DC: transmitter/receiver active, normal function

For easier operation, the switching input can be activated/deactivated via switch **S1** (see chapter 4.4.1, figure 4.4 and figure 4.5):

Position S1:	On	the switching input is not analyzed. The transmitter/receiver unit is always in operation (internal preselection of the switching input with Vin).
	Off	the switching input is analyzed. Depending on the input voltage, normal function or transmitter/receiver unit switched off.



Note!

When transmitter/receiver unit is switched off, the system behaves in the same way as in the event of a light beam interruption (see chapter 11.4 "Operation").

The switching input can be used, for example, during a corridor change to completely avoid interference effects from other sensors or the data transmission.

Switch S1 is also present on the device models with M12 connectors.

Switching output

The DDLS 200 is equipped with a switching output **OUT WARN** which is activated if the receiving level in the receiver drops.

Output voltage: 0 ... 2 V DC: Operating range
(relative to GND) Vin - 2 V DC: warning or shutoff range

The switching output is protected against: short-circuit, overcurrent, overvoltage, overheating and transients.



Note!

The DDLS 200 is still completely functional when the level of the receiving signal drops to the warning signal level. Checking the alignment, and, if applicable, a readjustment and/or cleaning of the glass pane leads to a significant improvement of the received signal level.

5 PROFIBUS / RS 485

The PROFIBUS model of the DDLS 200 has the following features:

- Operating ranges 30m, 80m, 120m, 200m, 300m, 500m
- Electrically isolated interface
- The DDLS 200 does not occupy a PROFIBUS address
- Integrated repeater function (signal processing), can be switched off
- Protocol-independent data transmission, i.e. transmission of the FMS, DP, MPI, FMS/DP mixed operation protocols, PROFISAFE
- 2 connection variants: terminal connection with screwed cable glands or M12 connectors
- Connectable bus terminator (termination), or ext. terminator plug on the M12 model
- 6 baud rates configurable (see chapter 5.3)
- Optional M12 connector set for conversion available as accessory
- It is possible to cascade several DDLS 200 (see chapter 4.3)

5.1 PROFIBUS connection - devices with screwed cable glands and terminals

The electrical connection to the PROFIBUS is made at the terminals **A**, **B**, and **COM**. The terminals **A'**, **B'** and **COM** are provided for wiring through the bus.

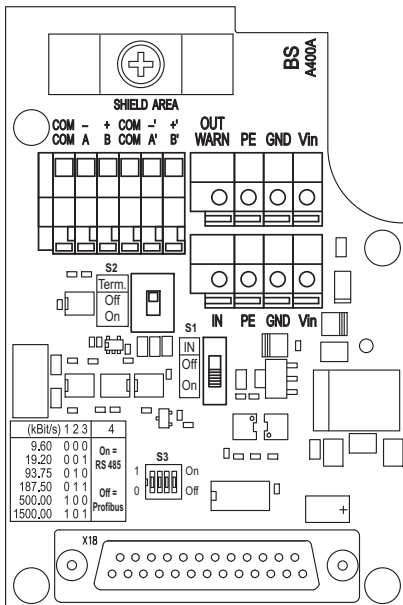

PROFIBUS - terminals and switches

Terminal	Function
A , -	(N) PROFIBUS or (-) RS 485
B , +	(P) PROFIBUS or (+) RS 485
COM	Potential equalization
A' , -'	(N) PROFIBUS or (-) RS 485 of the wired-through bus
B' , +'	(P) PROFIBUS or (+) RS 485 of the wired through bus
Switch Function	
S2	Termination On/Off
S3-1 ... S3-3	Setting the baud rate of the PROFIBUS segment
S3-4	Changeover PROFIBUS (Off) / RS 485 (On)

Figure 5.1: Connection board for PROFIBUS model with terminals and screwed cable glands



Attention!

Please be sure to observe the installation requirements (bus cables, cable lengths, shielding, etc.) defined in the PROFIBUS standard EN 50170 (Vol. 2).

5.1.1 Converting the PROFIBUS model with terminals to M12 connectors

Available as an optional accessory is an M12 connector set, consisting of M12 connector (A-coded, power), M12 connector (B-coded, bus) and M12 socket (B-coded, bus), with ready-made wires (Part No. 500 38937). This can be used to convert the PROFIBUS models with terminals/screwed cable glands to M12 connectors.

Conversion to M12 connectors

1. Remove screwed cable gland 1, 2 and 3 (spanner size = 20mm)
2. Screw M12 plug (power) into the thread of the screwed cable gland 1 that you have just removed and tighten it with spanner SW18.
3. Screw M12 socket (bus) into the thread of the screwed cable gland 2 that you have just removed and tighten it with spanner SW18.
4. Screw M12 plug (bus) into the thread of the screwed cable gland 3 that you have just removed and tighten it with spanner SW18.
5. Connect cables acc. to figure 5.2 and Table 5.1.

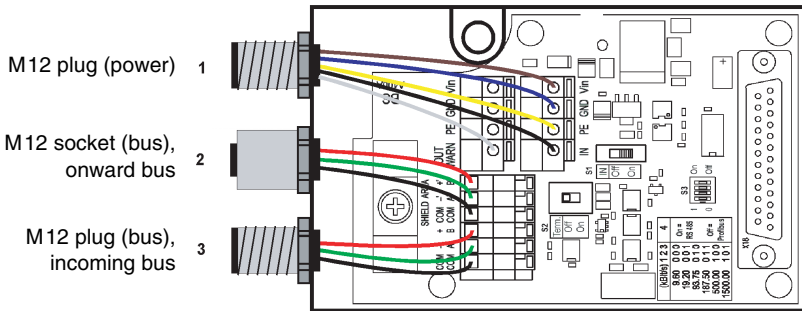

Figure 5.2: Installation and connection of the optional M12 connectors

(1) M12 plug (Power)		(2) M12 socket (bus), onward bus		(3) M12 plug (bus), incoming bus	
Pin 1 (brown)	Vin	Pin 1 (not used)	–	Pin 1 (not used)	–
Pin 2 (white)	OUT	Pin 2 (green)	A'	Pin 2 (green)	A
Pin 3 (blue)	GND	Pin 3 (black)	COM	Pin 3 (black)	COM
Pin 4 (black)	IN	Pin 4 (red)	B'	Pin 4 (red)	B
Pin 5 (yellow/green)	PE	Pin 5 (not used)	–	Pin 5 (not used)	–
		Screw fitting	Shield	Screw fitting	Shield

Table 5.1: Connection of M12 connectors



Note!

The orientation of the M12 connectors is not defined. The use of angular M12 connectors as counterparts is therefore discouraged.

An external termination on the M12 socket is **not** possible. For terminating the device, the termination switch **S2** must be used always

5.2 PROFIBUS connection - devices with M12 connectors

The electrical connection of the PROFIBUS is easily performed using M12 connectors. Ready-made connection cables are available as accessories both for connecting the incoming bus as well as for connecting the continuing bus (see chapter 14 "Accessories").

For all M12 device models, the connection is made via the two left, B-coded connectors **BUS IN** and **BUS OUT** (see figure 5.3).

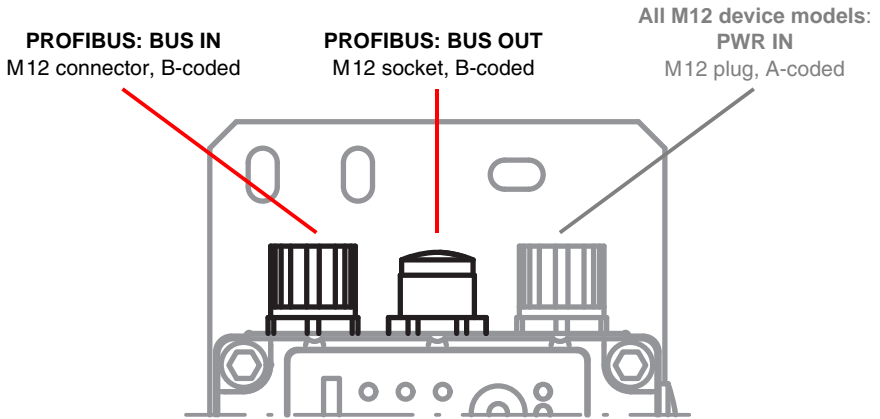

Figure 5.3: Location and designation of the M12 PROFIBUS connections

BUS IN (5-pin M12 plug, B-coded)			
	Pin	Name	Remark
	1	NC	Not used
	2	A (N)	Receive/transmit data A-line (N)
	3	GNDP	Data reference potential
	4	B (P)	Receive/transmit data B-line (P)
	5	NC	Not used
Thread	FE	Functional earth (housing)	

Figure 5.4: Assignment M12 connector BUS IN

BUS OUT (5-pin M12 socket, B-coded)			
BUS OUT	Pin	Name	Remark
 <p>M12 socket (B-coded)</p>	1	VCC	5VDC for bus terminator (termination)
	2	A (N)	Receive/transmit data A-line (N)
	3	GNDP	Data reference potential
	4	B (P)	Receive/transmit data B-line (P)
	5	NC	Not used
Thread	FE	Functional earth (housing)	

Figure 5.5: Assignment M12 connector BUS OUT

Termination for devices with M12 connectors

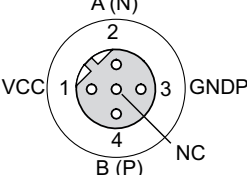

Note!

If the PROFIBUS network begins or ends at the DDLS 200 (not a continuing bus), the **BUS OUT** connection must be terminated with the TS 02-4-SA terminator plug, which is available as an optional accessory (see chapter 14.1 on page 67).

In this case, please also order the TS 02-4-SA terminator plug.

5.3 Device configuration PROFIBUS

Termination for devices with screwed cable glands and terminals

The PROFIBUS can be terminated via the switch **S2** in the DDLS 200. If the **termination is active (S2 = On)**, internal bus resistors are connected as per the PROFIBUS standard and the PROFIBUS is not wired through at terminals **A'** and **B'**.

Activate the termination when the PROFIBUS segment begins or ends at the DDLS 200. The default setting is **termination inactive (S2 = Off)**.

Adjustment of the transmission rate

You must set the transmission rate of your PROFIBUS segment using the three DIP switches S3-1 through S3-3. Possible transmission rates are:

- 9.6 kbit/s
- 19.2 kbit/s
- 93.75 kbit/s
- 187.5 kbit/s ¹⁾
- 500 kbit/s ¹⁾
- 1500 kbit/s ¹⁾

Set the transmission rate in accordance with the table printed on the connection circuit board (see figure 5.1). The default setting is:

- 9.6kbit/s for DDLS 200 PROFIBUS device models with terminal connection
- 1500kbit/s for DDLS 200 PROFIBUS device models with M12 connection

1) Not for 500m operating range!

PROFIBUS / RS 485 changeover (default: 'Off' = PROFIBUS)

The DDLS 200 has, as a standard function, a repeater function (signal processing) and is, with regard to the PROFIBUS, to be viewed as a repeater.



Note!

Please observe the guidelines specified in EN 50170 (Vol. 2) regarding the use of repeaters. The delay time of a data transmission path is maximum $1.5 \mu s + 1 T_{bit}$.

It is also possible to transmit other RS 485 protocols. For PROFIBUS applications, S3-4 should be set to 'Off' ('0'). DIP-switch S3-4 can be used to switch off the repeater function for non-PROFIBUS applications (S3-4 = 'On'). In this case, no signal regeneration takes place; the RS 485 protocol must, however, still provide certain features

Please contact the manufacturer if you would like to use the DDLS 200 for general RS 485 protocols.

5.4 LED Indicators PROFIBUS

In addition to the indicator and operating elements present in all device models (bar graph, buttons, LEDs AUT, MAN, ADJ; see chapter 11.1 "Indicator and operating elements"), the PROFIBUS model includes the following additional indicators:

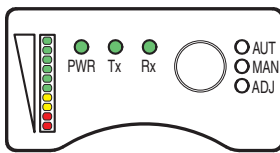

- LED PWR: green = operating indicator
- green flashing= transmitter /receiver unit switched off via switching input **IN** or hardware error
- off = no operating voltage
- LED Tx: green = data are being transmitted to the bus
- green flashing= with baud rates set to very low values, the LEDs **Tx** and **Rx** flicker. At very high baud rates (> 50kbit/s), flashing LEDs **Tx** and **Rx** indicate faulty bus communication.
- off = no data on the transmission line
- LED Rx: green = data are being received by the bus
- green flashing= with baud rates set to very low values, the LEDs **Tx** and **Rx** flicker. At very high baud rates (> 50kbit/s), flashing LEDs **Tx** and **Rx** indicate faulty bus communication.
- off = no data on the reception line

Figure 5.6:Indicator/operating elements for the PROFIBUS model

6 INTERBUS 500kbit/s / RS 422

The INTERBUS model of the DDLS 200 has the following features:

- Operating ranges 30m, 120m, 200m, 300m, for INTERBUS
- Electrically isolated interface
- The DDLS 200 is **not an** INTERBUS subscriber
- Protocol-independent data transmission, transparent compared to other RS 422 protocols
- 500kbit/s fixed transmission rate with INTERBUS, with RS 422 generally lower transmission rates as well
- Operating range 500m for RS 422 up to 100kbit/s
- Cascading of several DDLS 200 is possible (see chapter 4.3)

6.1 Electrical connection INTERBUS 500kbit/s

The electrical connection to the INTERBUS is made at terminals **DO... / DI...** and **COM** as shown in figure 6.1.

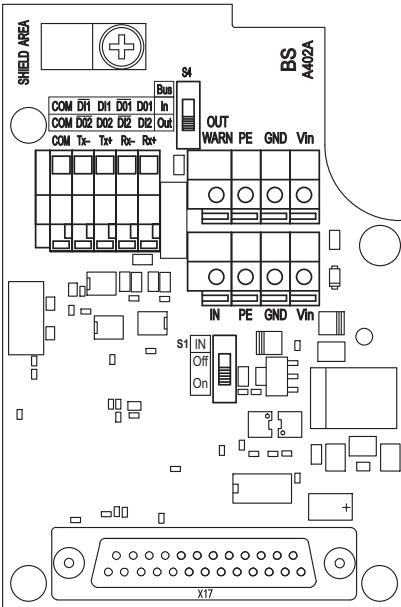

INTERBUS - terminals and switches

Terminal	Function
DO1 / DI2, Rx+	Reception line +
DO1 / DI2, Rx-	Reception line -
DI1 / DO2, Tx+	Transmission line +
DI1 / DO2, Tx-	Transmission line -
COM	Potential equalization
Switch	Function
S4	Position In : incoming bus with shielding connection via RC circuit
	Position Out (default) : outgoing bus with direct shielding connection

Figure 6.1: Connection circuit board of the INTERBUS model



Attention!

Please be sure to observe the installation requirements (bus cables, cable lengths, shielding, etc.) defined in the INTERBUS standard EN 50254

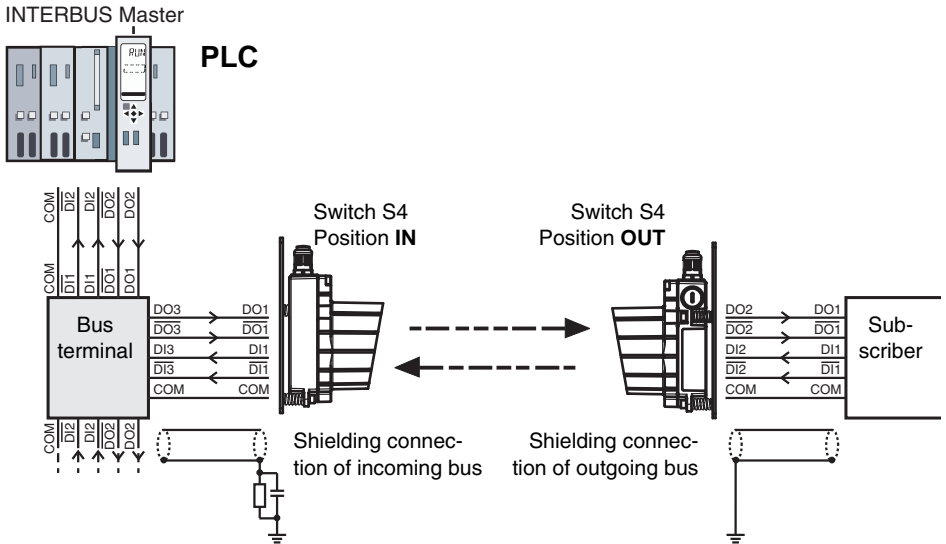

Figure 6.2: Connection of the DDLS 200 to the INTERBUS (copper line)

6.2 Device configuration INTERBUS 500kbit/s / RS 422

Device configuration INTERBUS

Changeover incoming/outgoing bus and shielding connection (default: 'Out')

Switch **S4** must be used to specify in the DDLS 200 whether the connected bus cable is for the incoming bus (In) or outgoing bus (Out):

- Switch S4** Position In: incoming bus, the shielding connection (clamp) is connected via an RC circuit to PE.
- Position Out: outgoing bus, the shielding connection (clamp) is connected directly to PE.

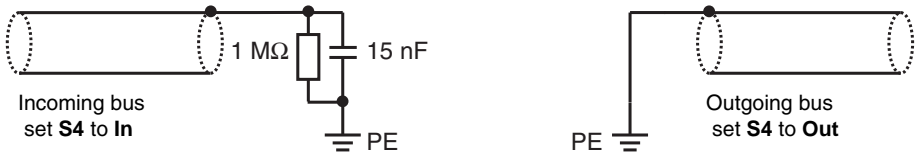

Figure 6.3: Shielding connection for incoming/outgoing bus

Device configuration RS 422

General RS 422 protocols can be transmitted with the DDLS 200. No baud rate setting is necessary (max. 500kbit/s). The shielding connection can be set via switch S4 as with the Interbus.



Note!

The latency of a light path is about 1.5 μs (depending on the distance).

6.3 LED indicators INTERBUS 500kbit/s / RS 422

In addition to the indicator and operating elements present in all device models (bar graph, buttons, LEDs AUT, MAN, ADJ; see chapter 11.1 "Indicator and operating elements"), the INTERBUS model includes the following additional indicators:

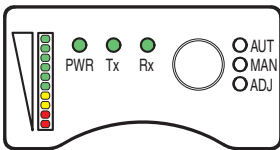

- LED PWR: green = operating indicator
- green flashing = transmitter /receiver unit switched off via switching input **IN** or hardware error
- off = no operating voltage
- LED Tx: green = data are being transmitted to the bus
- green flashing = with baud rates set to very low values, the LEDs **Tx** and **Rx** flicker. At very high baud rates (> 50kbit/s), flashing LEDs **Tx** and **Rx** indicate faulty bus communication.
- off = no data on the transmission line
- LED Rx: green = data are being received by the bus
- green flashing = with baud rates set to very low values, the LEDs **Tx** and **Rx** flicker. At very high baud rates (> 50kbit/s), flashing LEDs **Tx** and **Rx** indicate faulty bus communication.
- off = no data on the reception line

Figure 6.4:Indicator/operating elements for the INTERBUS model

7 INTERBUS 2Mbit/s Fiber-Optic Cable

The INTERBUS fiber-optic-cable model of the DDLS 200 has the following features:

- Operating ranges 200m, 300m
- Transmission protected against interference through the use of fiber-optic cables
- Bus connection by means of polymer-fiber-cable with FSMA connector
- The DDLS 200 is an INTERBUS subscriber (Ident-Code: 0x0C = 12_{dec.}), but does not occupy data in the bus
- Adjustable transmission rate 500kbit/s or 2Mbit/s
- Cascading of several DDLS 200 is possible (see chapter 4.3)

7.1 Fiber-optic-cable connection INTERBUS 2Mbit/s

The connection to the INTERBUS is by means of the FSMA connectors **H1** and **H2** as shown in figure 7.1.

Recommended fiber-optic cable:

- PSM-LWL-KDHEAVY... (Phoenix Contact)
- PSM-LWL-RUGGED... (Phoenix Contact)



Note!

The maximum length of the fiber-optic cables is 50m.

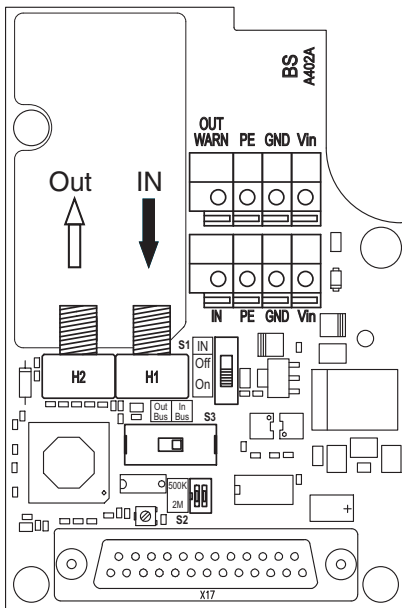

INTERBUS - terminals and switches

Fiber-optic-cable socket	Function
H1	Receiver fiber-optic cable
H2	Transmitter fiber-optic cable
Switch	Function
S2	Position 500k : INTERBUS fiber-optic-cable transmission rate 500 kbit/s
	Position 2M (default) : INTERBUS fiber-optic-cable transmission rate 2 Mbit/s
S3	Position In Bus (default) : incoming bus fiber-optic cable
	Position Out Bus : outgoing bus fiber-optic cable

Figure 7.1: Connection circuit board of the INTERBUS model



Attention!

Please be sure to observe the installation requirements defined in the INTERBUS standard EN 50254 and follow the handling and installation specifications for fiber-optic cables as specified by the manufacturer.

For the **infeed of the fiber-optic cable**, use only the **large screwed cable gland M20 x 1.5**. **Make certain that bending radii are not tighter than specified for the used fiber-optic-cable type!** **Observe the maximum fiber-optic cable length!**

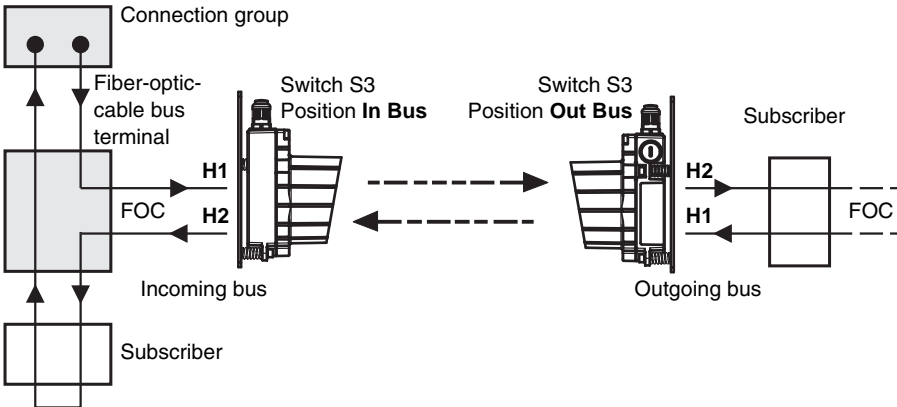

Figure 7.2: Connection of the DDLS 200 to the INTERBUS (fiber-optic cable)

7.2 Device configuration INTERBUS 2Mbit/s FOC

Transmission rate changeover (default: '2M')

In the DDLS 200, switch **S2** must be used to specify in the transmission rate of the fiber-optic-cable INTERBUS:

- Switch S2** Position **500k**: transmission rate 500 kbit/s.
- Position **2M (default)**: transmission rate 2 Mbit/s.

Changeover incoming/outgoing bus (default: 'In Bus')

Switch **S3** must be used to specify in the DDLS 200 whether the connected fiber-optic cable is for the incoming bus (In Bus) or outgoing bus (Out Bus):

- Switch S3** Position **In Bus (default)**: incoming bus - fiber-optic cable; outgoing bus - optical data transmission.
- Position **Out Bus**: incoming bus - optical data transmission; outgoing bus - fiber-optic cable.



Note!

The delay time of a light path is approx. 2.5 μ s.

7.3 LED indicators INTERBUS 2Mbit/s fiber-optic cable

In addition to the indicator and operating elements present in all device models (bar graph, buttons, LEDs AUT, MAN, ADJ; see chapter 11.1 "Indicator and operating elements"), the INTERBUS model includes the following additional indicators:

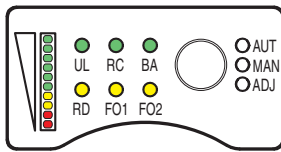

LED UL:	green	= operating indicator (Power on)
	green flashing	= transmitter /receiver unit switched off via switching input IN or hardware error
	off	= no operating voltage
LED RC:	green	= INTERBUS connection OK
	off	= INTERBUS in reset mode or connection not OK
LED BA:	green	= display of bus activity
	off	= no bus activity
LED RD:	yellow	= continuing bus switched off
	off	= continuing bus detected
LED FO1:	yellow	= initialization faulty or MAU warning (Master in RUN state)
	off	= initialization OK, no MAU warning (Master in READY state)
LED FO2:	yellow	= initialization faulty or MAU warning (Master in RUN state)
	off	= initialization OK, no MAU warning (Master in READY state)

- UL** = logic voltage U_L
- RC** = Remote Bus Check
- BA** = Bus Activity
- RD** = Remote Bus Disable
- FO1** = Fiber Optics 1
- FO2** = Fiber Optics 2

Figure 7.3: Indicator/operating elements for the INTERBUS model



Note!

The DDLS 200 is an INTERBUS subscriber (Ident-Code: 0x0C = 12_{dec}). A current CMD subscriber description can be downloaded from <http://www.leuze.com>.

If the value falls below the warning level (bar graph), a peripheral error message is transmitted via the INTERBUS. When this error message is transmitted, the usual cause is soiling of the glass optics (see chapter 12.1 "Cleaning"), an incorrectly adjusted data transmission path, or an interrupted light path.

You can also use the diagnostic options available via the INTERBUS.

8 Data Highway + (DH+) / Remote I/O (RIO)

The DH+/RIO model of the DDLS 200 has the following features:

- Operating ranges 120m, 200m, 300m
- Electrically isolated interface
- Direct connection to the Data Highway + and Remote I/O bus from Rockwell Automation (Allen Bradley)
- Adjustable transmission rate 57.6 / 115.2 or 230.4 kbit/s
- Cascading of several DDLS 200 is possible (see chapter 4.3)

8.1 Electrical connection DH+ / RIO

The electrical connection to the DH+ / RIO bus is made acc. to the table on the connection board at terminals 1, 2 and 3. Each of these terminals is provided twice for wiring through the bus.

Cable to be used: Bluehouse Twinax (Belden 9463 or Allen Bradley 1770-CD)

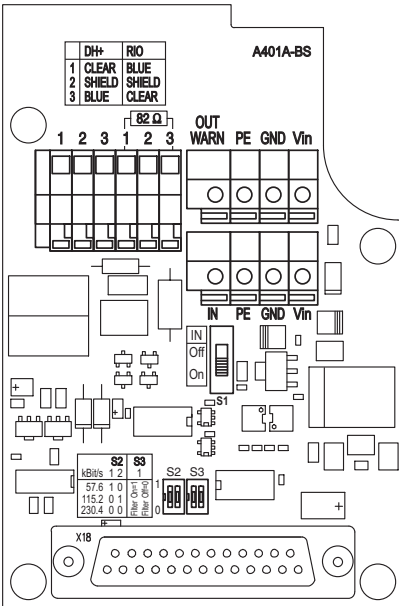

DH+/RIO - terminals and switches

Terminal	Assignment DH+	Assignment RIO
1	CLEAR	BLUE
2	SHIELD	SHIELD
3	BLUE	CLEAR
Switch	Function	
S2-1, S2-2	Setting the transmission rate (see table on the connection circuit board), default: 230.4 kbit/s	
S3-1	Filter for interference-peak rejection. Position On (1): Filter switched-on (default) Position Off (0): Filter switched off	
S3-2	Not used	

Figure 8.1: Connection circuit board of the DH+ / RIO model



Attention!

The right DH+ / RIO connections 1 and 3 are equipped standard with an 82 Ω resistor for terminating the bus. Remove this terminating resistor when the bus cable in the DDLS 200 is to be wired through to another bus subscriber, i.e. the DDLS 200 is not the last device on the bus cable. The use of the DDLS 200 is limited to bus systems with 82 Ω termination.

8.2 Device configuration DH+ / RIO

Cascading of multiple DDLS 200 transmission paths (filter, default: 'On' = on)

If multiple DDLS 200 transmission paths are to be cascaded within a bus segment (see figure 8.2), the filter for interference-peak suppression (switch **S3-1**) must be adjusted appropriately for the selected transmission rate. Observe also the notices in chapter 4.3.

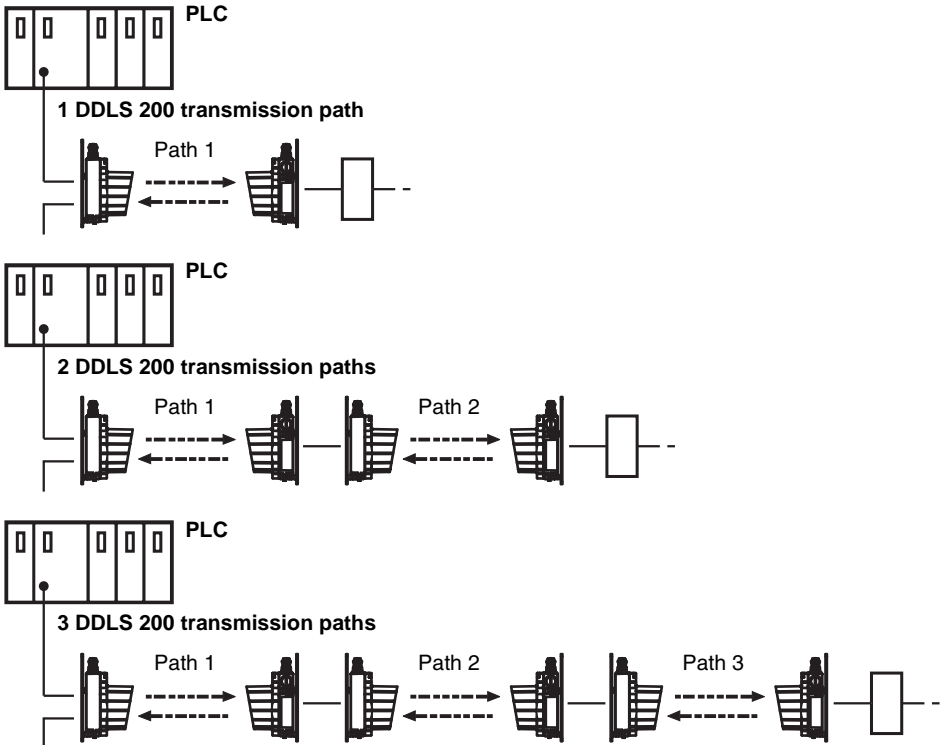

Figure 8.2: Cascading multiple optical transmission paths with DH+ / RIO

In accordance with the following table, set the filter for each DDLS 200 transmission path at both devices for the given path using switch S3-1.

Baud rate	1 path	Position of S3-1 for 2 paths	3 paths
57.6kbit/s	Path 1: On (1)	Path 1: On (1) Path 2: Off (0)	Path 1: On (1) Path 2: Off (0) Path 3: Off (0)
115.2kbit/s and 230.4kbit/s	Path 1: On (1)	Path 1: On (1) Path 2: On (1)	Path 1: On (1) Path 2: On (1) Path 3: On (1)

Table 8.1: Filter settings when cascading multiple DDLS 200 transmission paths

**Note!**

The delay time of a light path is approx.:

S3-1 On (1) = approx. $1.5 \mu\text{s} + 1.5 T_{bit}$

S3-1 Off (0) = approx. $1.5 \mu\text{s}$

8.3 LED indicators DH+ / RIO

In addition to the indicator and operating elements present in all device models (bar graph, buttons, LEDs AUT, MAN, ADJ; see chapter 11.1 "Indicator and operating elements"), the DH+/RIO model includes the following additional indicators:

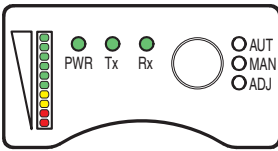

LED PWR:	green	= operating indicator
	green flashing	= transmitter/receiver unit switched off via switching input IN or hardware error
LED Tx:	off	= no operating voltage
	green	= data are being transmitted to the bus
LED Rx:	green flashing	= with baud rates set to very low values, the LEDs Tx and Rx flicker. At very high baud rates (> 50kbit/s), flashing LEDs Tx and Rx indicate faulty bus communication.
	off	= no data on the transmission line
	green	= data are being received by the bus
	green flashing	= with baud rates set to very low values, the LEDs Tx and Rx flicker. At very high baud rates (> 50kbit/s), flashing LEDs Tx and Rx indicate faulty bus communication.
	off	= no data on the reception line

Figure 8.3: Indicator/operating elements of the DH+/RIO model

**Note!**

You can also use the diagnostic options available via the bus system.

9 DeviceNet / CANopen

The DeviceNet/CANopen model of the DDLS 200 has the following features:

- Operating ranges 120m, 200m, 300m
- The DDLS 200/____-50 can transmit both DeviceNet as well as CANopen protocols
- Electrically isolated interface
- The DDLS 200 does not occupy an address
- CAN controller acc. to 2.0B standard
- Can simultaneously process 11-bit and 29-bit identifiers
- 8 baud rates can be set (10, 20, 50, 125, 250, 500, 800kbit/s, 1 Mbit/s)
- Baud rate conversion possible
- With DDLS 200 it is possible to extend the overall size of a CAN network
- M12 connector set available as accessory
- Various supply options are possible for the device
- Cascading of several DDLS 200 is possible (see chapter 4.3)

9.1 Electrical connection DeviceNet / CANopen - screwed cable glands/terminals

The electrical connection to DeviceNet / CANopen is made at terminals V-, CAN_L, DRAIN, CAN_H, V+. The terminals are available as double connectors for wiring through the bus.

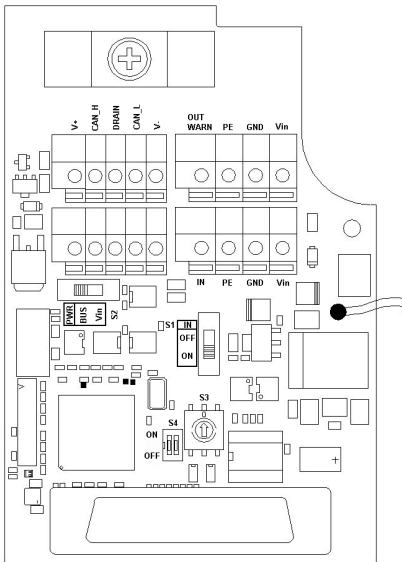

No.	Terminal	Cable color	Function
1	V-	black	neg. supply (CAN ground reference)
2	CAN_L	blue	bus signal (LOW)
3	DRAIN	transparent	shield
4	CAN_H	white	bus signal (HIGH)
5	V+	red	pos. supply
Switch	Position	Function	
S2	BUS	bus transceivers are supplied via the bus cable (V- and V+ lines)	
	Vin default	bus transceivers are supplied via internal DC/DC converters	
S3	0 default	125kbit baud rate	CANopen / DeviceNet
	1	250kbit baud rate	CANopen / DeviceNet
	2	500kbit baud rate	CANopen / DeviceNet
	3	10kbit baud rate	CANopen
	4	20kbit baud rate	CANopen
	5	50kbit baud rate	CANopen
	6	800kbit baud rate	CANopen
	7	1000kbit baud rate	CANopen
	8	Reserved	
	9	Reserved	
ON		sorting memory is active	

Figure 9.1: DeviceNet / CANopen, connection-board variant



Attention!

The maximum permissible current which may pass over terminals V+ / V- is 3A; the maximum permissible voltage is 25V (11 ... 25V)!

9.1.1 Bus transceiver and device supplied via separate power connection

- Switch S2 = Vin.
- Bus electrically insulated (isolated node)
- CAN_GND must be connected to V-

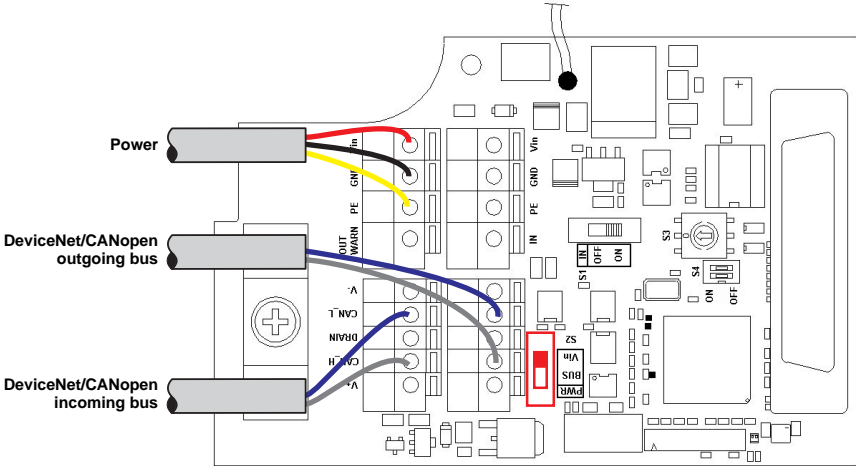

Figure 9.2: Bus transceiver and device supplied via separate power connection

9.1.2 Bus transceiver supplied via bus cable, device supplied via separate power line

- Switch S2 = BUS.
- Bus electrically insulated (isolated node)

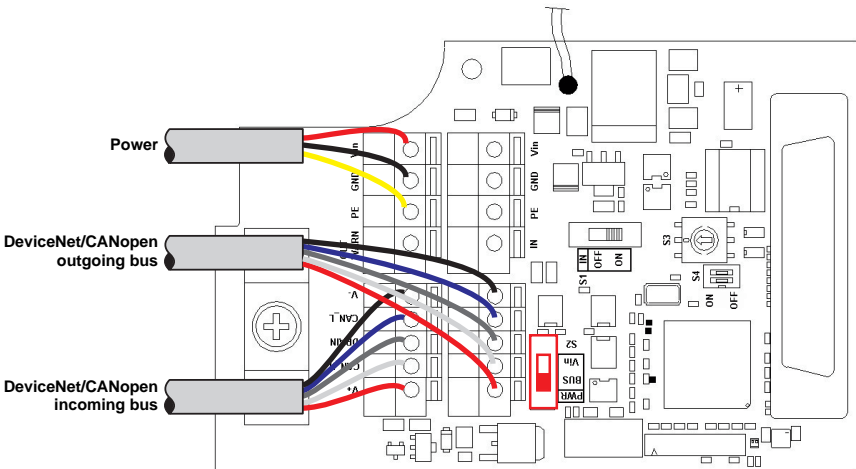

Figure 9.3: Bus transceiver supplied via bus cable, device supplied via separate power line

9.1.3 Bus transceiver and device supplied via bus cable

- Switch S2 = BUS.
- Bus **not** electrically insulated (non-isolated node)
- Current consumption see chapter 3 "Technical Data".

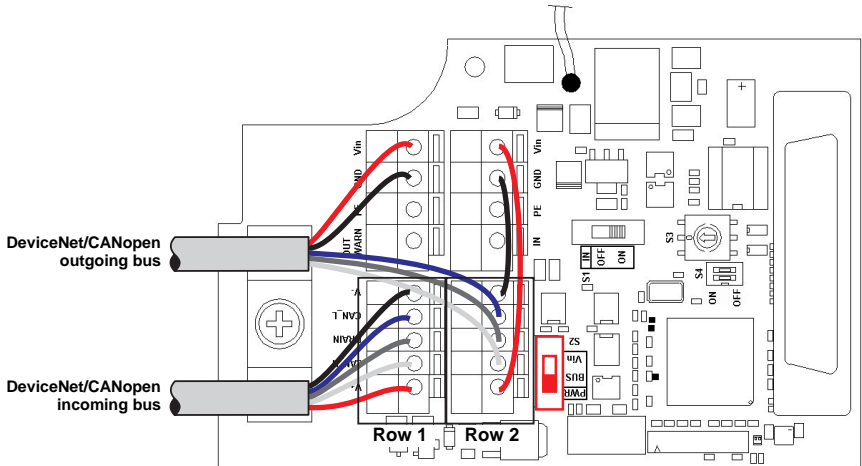

Figure 9.4: Bus transceiver and device supplied via bus cable

Incoming bus cable		Outgoing bus cable	
Cable	Terminal	Cable	Terminal
V- (black)	V- (row 1)	V- (black)	GND
CAN_L (blue)	CAN_L (row 1)	CAN_L (blue)	CAN_L (row 2)
DRAIN (transparent)	DRAIN (row 1)	DRAIN (transparent)	DRAIN (row 2)
CAN_H (white)	CAN_H (row 1)	CAN_H (white)	CAN_H (row 2)
V+ (red)	V+ (row 1)	V+ (red)	Vin
Bridge between Vin and V+ (row 2)			
Bridge between GND and V- (row 2)			

Table 9.1: Connection table



Note!

In order for this interface connection to be conformant with the DeviceNet Ground concept, the load on the switching output and/or the source at the switching input must be potential free.

If the complete device is operated using the supply in the bus cable, it must be ensured that the voltage is at least 18V.

The total current of the device is the device current plus the current drawn at the switching output.

9.1.4 Installation and connection of the optional M12 connectors

An M12 connector set is available as an accessory. It consists of an M12 plug (power), an M12 plug (bus), and an M12 socket (bus) with ready-made cables (Part No. 500 39348). If the M12 connector set is used, a possible termination should be carried out with the optionally available terminal connector.

Conversion to M12 connectors

1. Remove screwed cable gland 1, 2 and 3 (spanner size = 20mm)
2. Screw M12 plug (power) into the thread of the screwed cable gland 1 that you have just removed and tighten it with spanner SW18.
3. Screw M12 socket (bus) into the thread of the screwed cable gland 2 that you have just removed and tighten it with spanner SW18.
4. Screw M12 plug (bus) into the thread of the screwed cable gland 3 that you have just removed and tighten it with spanner SW18.
5. Connect cables acc. to figure 9.5 and Table 9.2.

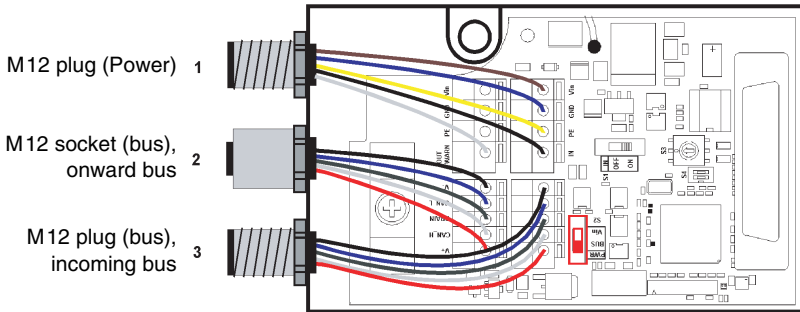

Figure 9.5: Installation and connection of the optional M12 connectors

(1) M12 plug (Power)		(2) M12 socket (bus), onward bus		(3) M12 plug (bus), incoming bus	
Pin 1 (brown)	Vin	Pin 1 (transparent)	DRAIN	Pin 1 (transparent)	DRAIN
Pin 2 (white)	OUT	Pin 2 (red)	V+	Pin 2 (red)	V+
Pin 3 (blue)	GND	Pin 3 (black)	V-	Pin 3 (black)	V-
Pin 4 (black)	IN	Pin 4 (white)	CAN_H	Pin 4 (white)	CAN_H
Pin 5 (yellow/green)	FE	Pin 5 (blue)	CAN_L	Pin 5 (blue)	CAN_L

Table 9.2: Connection of M12 connectors



Note!

The orientation of the M12 connectors is not defined. The use of angular M12 connectors as counterparts is therefore discouraged.

9.2 DeviceNet/CANopen electrical connection- M 12 connectors

The electrical connection of DeviceNet/CANopen is performed using M12 connectors.

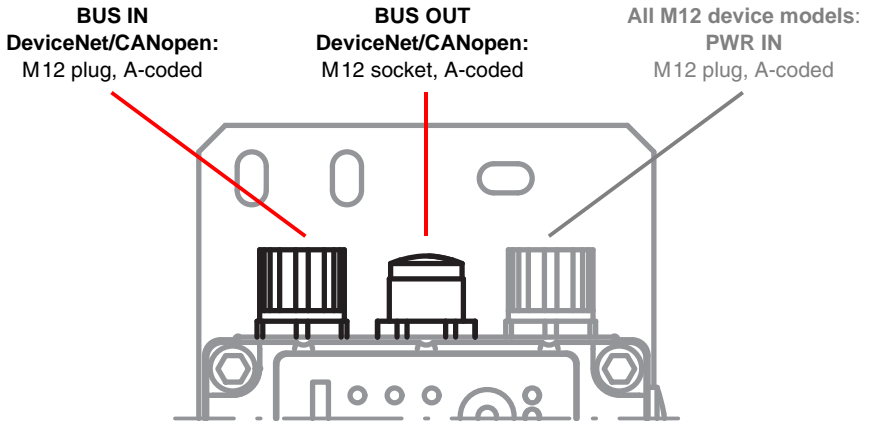

Figure 9.6: Location and designation of the M12 DeviceNet/CANopen connections

BUS IN (5-pin M12 plug, A-coded)			
BUS IN	Pin	Name	Remark
<p>BUS IN M12 plug (A-coded)</p>	1	Drain	shield
	2	V+	Positive supply bus transceiver (switch S2 = bus)
	3	V-	Negative supply bus transceiver (switch S2 = bus)
	4	CAN_H	Bus signal High
	5	CAN_L	Bus signal Low
	Thread	FE	Functional earth (housing)

Figure 9.7: Assignment M12 connector BUS IN

BUS OUT (5-pin M12 socket, A-coded)			
 <p>BUS OUT M12 socket (A-coded)</p>	Pin	Name	Remark
	1	Drain	Shield
	2	V+	Positive supply bus transceiver (switch S2 = bus)
	3	V-	Negative supply bus transceiver (switch S2 = bus)
	4	CAN_H	Bus signal High
	5	CAN_L	Bus signal Low
	Thread	FE	Functional earth (housing)

Figure 9.8: Assignment M12 connector BUS OUT

Via the selector switch **S2**, the bus transceiver can optionally be supplied via Power or **V+ / V-**.

S2 = Vin (**default**) bus transceivers are supplied internally

S2 = BUS, bus transceivers are supplied via **V+/V-**.

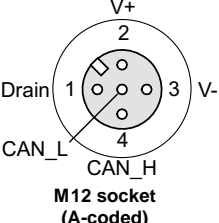

Attention!

The supply voltage **V+ / V-** is 11 ... 25VDC.

Termination



Note!

If the CANopen or DeviceNet network begins or terminates at the DDLS 200 (not a continuing bus), the **BUS OUT** connection must be terminated with the TS01-5-SA terminator plug (Part No. 50040099), which is available as an option.

In this case, please also order the TS 01-5-SA terminator plug.

9.3 Device configuration DeviceNet / CANopen

9.3.1 Baud rate conversion

Through the use of an optical transmission system, the bus is divided into two segments. Different baud rates can be used in the physically separated segments. The DDLS 200s then function as baud rate converters. During baud rate conversion, it must be ensured that the bandwidth of the segment with the lower baud rate is adequate for processing the incoming data.

9.3.2 Sorting (switch S4.1)

With the aid of switch S4.1, sorting of the internal memory can be activated and deactivated. If sorting is deactivated (**switch S4.1 = OFF, default**), CAN frames are handled according to the FIFO principle (First-In-First-Out).

If sorting is active (switch S4.1 = ON), CAN frames are sorted according to their priority. The message with the highest priority in memory is the next one to be put onto the connected network for arbitration.

9.3.3 Bus lengths as a function of the baud rate

Switch position S3	Baud rate	max. cable length per bus segment	Interface
0 (default)	125kbit	500m	CANopen / DeviceNet
1	250kbit	250m	CANopen / DeviceNet
2	500kbit	100m	CANopen / DeviceNet
3	10kbit	5000m	CANopen
4	20kbit	2500m	CANopen
5	50kbit	1000m	CANopen
6	800kbit	50m	CANopen
7	1000kbit	30m	CANopen



Note!

The mechanical expansion of the bus system can be increased through the use of the DDLS 200.

9.4 Wiring

- The ends of the bus lines must be terminated between CAN_L and CAN_H for each physical bus segment (see figure 9.9 ).
- Typical CAN cables consist of a twisted-pair cable with a shield that is usually used as CAN_GND. Only use cables recommended for DeviceNet or CANopen.
- The ground reference CAN_GND must only be connected to earth potential (PE) at one place on a physical bus segment (see figure 9.9).

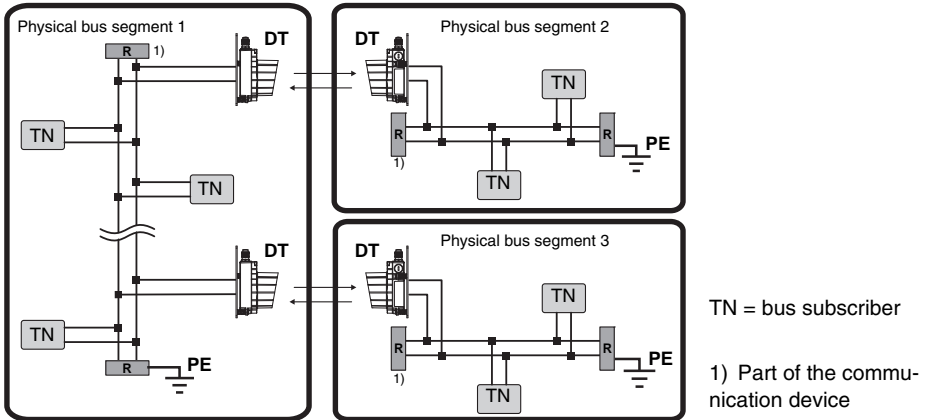

Figure 9.9: DeviceNet / CANopen wiring

9.4.1 Termination

DeviceNet

- External termination for M12 connector version is available as an option (see chapter 9.2)
- Resistance and other features are described in the DeviceNet specifications of the ODVA (Open DeviceNet Vendor Association).

CANopen

- Value: typically 120Ω (included with the device, mounted between CAN_L and CAN_H)
- External termination for M12 connector version is available as an option
- Resistance and other features are described in the CANopen specification ISO 11898.

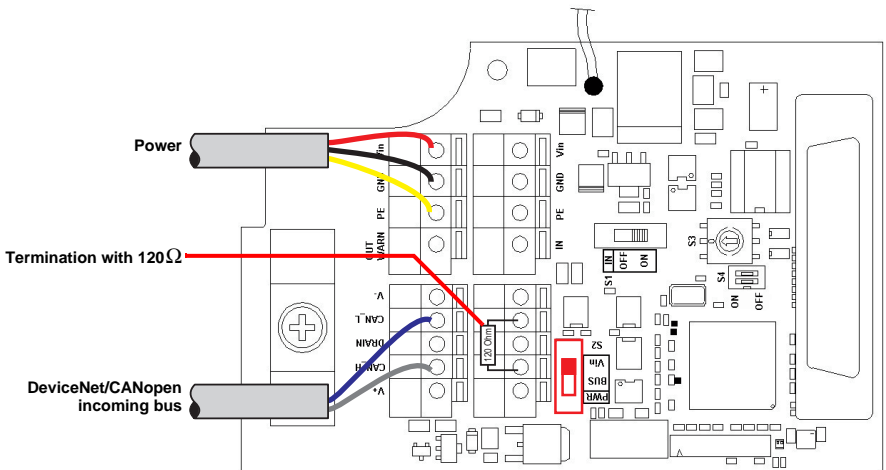
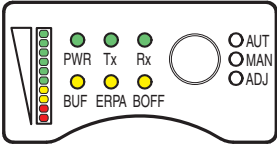

Figure 9.10: Termination in the unit.

A 120Ω resistor is connected standard between terminals CAN_L and CAN_H. If the device is not the last subscriber of the bus segment, the resistor must be removed and the outgoing bus cable connected to the terminal strip.

9.5 DeviceNet/CANopen LED indicators

In addition to the indicator and operating elements present in all device models (bar graph, buttons, LEDs AUT, MAN, ADJ; see chapter 11.1 "Indicator and operating elements"), the DeviceNet/CANopen model includes the following additional indicators:



- LED **PWR**: green = operating indicator
 green flashing = transmitter/receiver unit switched off via switching input **IN** or hardware error
 off = no operating voltage
- LED **Tx**: green = data are being transmitted to the bus
 green flashing = with baud rates set to very low values, or with low bus traffic, the LEDs **Tx** and **Rx** flicker.
 off = no data are being transmitted to the bus
- LED **Rx**: green = data are being received by the bus
 green flashing = with baud rates set to very low values, or with low bus traffic, the LEDs **Tx** and **Rx** flicker.
 off = no data on the reception line
- LED **BUF**: yellow = **buffer** load: >70%
 yellow flashing = **buffer** load: 30% ... 70%
 off = **buffer** load: <30%
- LED **ERPA**: yellow = DDLS 200 is in "**Error Passive**" state, full communication functionality, however in the event of an error, a passive error flag is sent (see also "BOSCH CAN Specification 2.0").
Measures:
 - check termination, wiring, baud rate
 off = DDLS 200 is in "**Error Active**" state, full communication functionality, however in the event of an error, an active error flag is sent, normal state
- LED **BOFF**: yellow = DDLS 200 in "**BusOff**" state, does **not** reattempt to participate in bus traffic ⇒ **manual intervention necessary**
Measures:
 - check termination, wiring, baud rate
 - power OFF/ON of the device supply or bus supply
 yellow flashing = DDLS 200 in the "**BusOff**" state, but does reattempt to participate in bus traffic
 off = DDLS 200 not in the "**BusOff**" state, normal state

Figure 9.11: Indicator/operating elements of the DeviceNet/CANopen model

9.6 Interruption of the data transmission path

Response upon interruption of the optical data transmission path

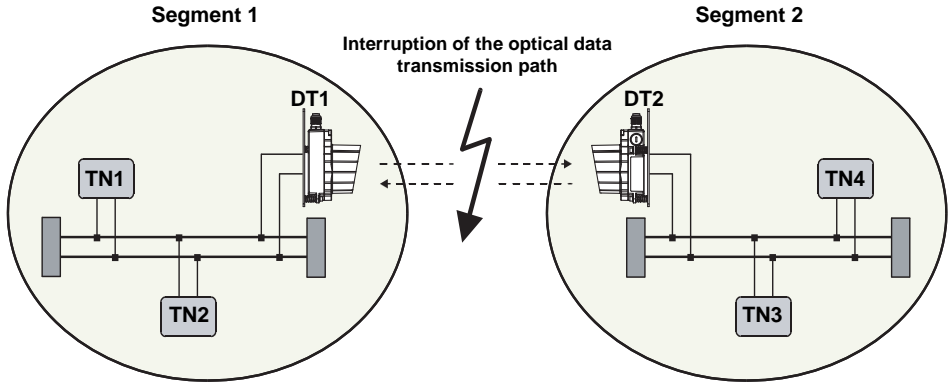

Figure 9.12: Interruption of the optical data transmission path

If only data fragments are received as the result of the interruption in the optical transmission path, these are detected and are not transmitted to the CAN bus segment. The connected subscribers are not informed of an interruption in the optical transmission path via the protocol (switching output is activated). Data transmitted during the interruption are lost. The primary protocol is responsible for management of the subscribers. For this reason, the monitoring mechanisms of the primary protocol should be used (Node/Life Guarding, Heartbeat, ...).

"Monitoring" of subscribers

If a DDLS 200 optical data transmission system is used in a DeviceNet or CANopen system, it is beneficial to monitor all subscribers to determine whether they are still participating in data exchange. The following mechanisms are available for this purpose:

Heartbeat

Subscribers transmit cyclical heartbeat messages. If a message is not received for a certain period of time, this is detected by the connected subscribers as a "Heartbeat Error".

Node / Life Guarding (CANopen)

The NMT Master (Network Management Master) cyclically queries all subscribers and expects an answer within a certain period of time. If this response is not received, a "Guarding Error" is detected.

Response in the event of buffer overload

If, as the result of errors on the CAN bus segment, no DDLS 200 data can be transmitted to this segment or data can be transmitted only sporadically, the DDLS 200 reacts as follows:

1. CAN frames are temporarily stored
(64 frames for baud rates ≥ 800 kbit and 128 frames for baud rates < 800 kbit).
2. If between 30% and 70% of the memory is occupied, the "BUF" LED flashes
3. If $> 70\%$ of the memory is occupied, the "BUF" LED is constantly illuminated
4. In the event of a buffer overflow, the memory is completely deleted.

Response in the event of errors on a sub-segment

Other segments are not informed of errors on a sub-segment.

9.7 Important notices for system integrators



Attention!

The notices provide initial information and describe the working principles of the optical data transceiver with DeviceNet and CANopen.

The notices must be read by each user before the first commissioning of the DDLS 200 with DeviceNet and CANopen.

Possible restrictions in the timing of the optical data transmission in comparison to copper-based data transmission are described here.

Due to the bit-synchronous arbitration mechanism in the CAN and the resulting high time requirements, arbitration via the optical, free-space data transmission system (abbreviated DT) is not possible. One original segment is divided into two sub-segments. Because of the division into multiple segments, there are several points which must be observed when designing the system.

9.7.1 Schematic drawing of the inner construction

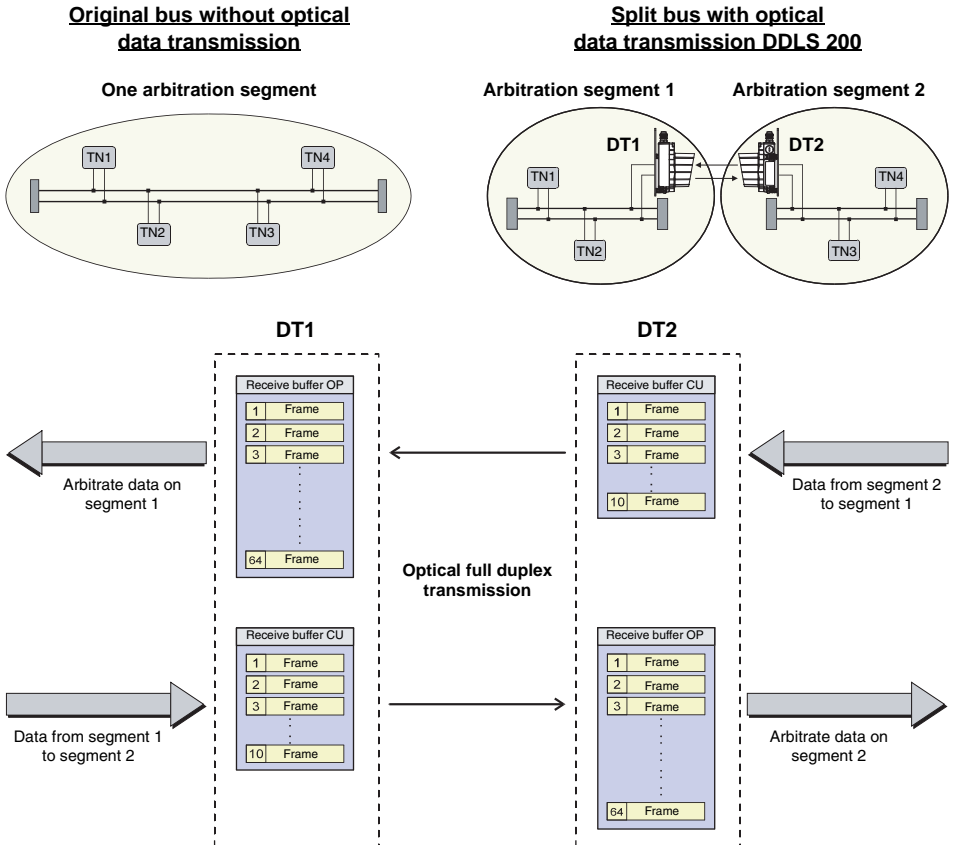

Figure 9.13: Segmentation

- Data from Segment 1 are written in reception buffer CU (10 frames) and optically transmitted directly from there.
- The transmitted data are received by the DT2 and written in reception buffer OP (64 frames > 800kbit and 128 frames < 800kbit).
- Data in reception buffer OP are sorted by priority or processed according to the FIFO principle (depending on the operating mode used)
- Data in reception buffer OP are passed to Segment 2 for arbitration.
- The same process also occurs when transmitting data from Segment 2 to Segment 1.

9.7.2 Timing

Telegram delay from segment to segment

- typical run-time delay of the messages in one direction
- calculated with 10% stuffing bits

Message memory not sorted (FIFO)

$$\text{Number of bits in the telegram} \cdot 1.1 \cdot (0.5\mu\text{s} + T_{\text{bit}}) + 10\mu\text{s}$$

Message memory sorted

$$\text{Number of bits in the telegram} \cdot 1.1 \cdot (0.5\mu\text{s} + T_{\text{bit}}) + 45\mu\text{s}$$

Example 1: DeviceNet			Example 2: CANopen		
<ul style="list-style-type: none"> • 125kbit/s (→ $T_{\text{bit}} = 8\mu\text{s}$) • 4 bytes of data • Message memory sorted 			<ul style="list-style-type: none"> • 1Mbit/s (→ $T_{\text{bit}} = 1\mu\text{s}$) • 8 bytes of data • Message memory not sorted (FIFO) 		
Protocol overhead	47 bits		Protocol overhead	47 bits	
Data	32 bits		Data	64 bits	
Stuffing bits	8 bits		Stuffing bits	12 bits	
→ Number of bits in the telegram	87 bits		→ Number of bits in the telegram	123 bits	
1 • Telegram length		696μs	1 • Telegram length		123μs
1 • Number of bits • 0.5μs		44μs	1 • Number of bits • 0.5μs		62μs
Processing		45μs	Processing		10μs
Typ. gross delay		785μs	Typ. gross delay		195μs

The maximum delay is dependent on various boundary conditions:

- bus load
- message priority
- history
- sorting active / not active

If a slave is addressed by a subscriber along an entire segment and expects an answer, twice the propagation time must be planned for (twice the optical path).

If multiple optical paths are used in a system, the delay times may be added (depending on the constellation in the bus).

The increased delay times must be taken into consideration when configuring the system.

9.7.3 Synchronous messages

As a result of dividing the network into multiple segments and the resulting delay of messages between the segments, there are limitations associated with synchronous transmission. The following types of telegrams are affected:

DeviceNet

Message	Function	Effects caused by DT
Bit strobe	Master simultaneously transmits 1 bit of output data to all subscribers.	All subscribers receive the message, but not simultaneously. Should therefore not be used for synchronization purposes.
Broadcast messages	One message is simultaneously transmitted to several subscribers.	All subscribers receive the message, but not simultaneously.

CANopen

Message	Function	Effects caused by DT
Sync	All subscribers are synchronized on a sync telegram, e.g. input data are read in and transmitted	The message is transmitted to all subscribers. Subscribers in another segment, e.g. Segment 2, receive this telegram with a time delay and are, thus, not synchronized with the subscribers in Segment 1.
Time stamp	Transmits time information.	All subscribers receive the message. Subscribers in a segment other than the producer of the message receive this information with a time delay. An error in the timing information results: $\text{min. } T_{\text{tot}} = \text{number of bits in the telegram} \times (0.5 \mu\text{s} + T_{\text{bit}}) + 100 \mu\text{s}$

9.7.4 Other implementation notes

Bus expansion is maximized by dividing into two sub-segments

- **without data transmission equipment:** 1 x max. bus length
- **with data transmission equipment:** 2 x max. bus length + optical path

With the DeviceNet, make certain that subscribers with large quantities of data or long response times are as high as possible in the scan list.

If the master of a DeviceNet network regularly begins a new scanning process even though not all slave responses have been received, proceed as follows

1. Make certain that subscribers with large quantities of data or long response times are as high as possible in the scan list. If not, the order should be rearranged.
2. Increase interscan delays until all responses are received within a single scanning cycle.

10 Ethernet

The Ethernet model of the DDLS 200 has the following features:

- Operating ranges 120m, 200m, 300m
- Supports 10Base-T and 100Base-TX (half and full duplex)
- Effective data transmission with 2Mbit/s full duplex
- Supports autopolarity and autonegotiation (Nway)
- Supports frames up to 1522 bytes in length
- The DDLS 200 for Ethernet does not occupy a MAC address
- Protocol-independent (transmits all protocols that are based on TCP/IP and UDP, e.g., Ethernet, Modbus TCP/IP, ProfiNet V1+V2)
- RJ-45 connector (a separate screwed cable gland is used to achieve protection class IP 65)
- M12 connectors, D-coded
- Conversion of 10Base-T to 100Base-TX and vice versa is possible
- Internal 16 kByte message memory (sufficient for approx. 250 short telegrams)
- Increased network expandability owing to optical data transmission:
 - without optical data transmission = 100m
 - with optical data transmission = 2 • 100m + optical transmission path
- It is possible to cascade several DDLS 200 (see chapter 4.3)

10.1 Ethernet connection - devices with screwed cable glands and terminals

Electrical connection to Ethernet is realized using the RJ45 socket X1.

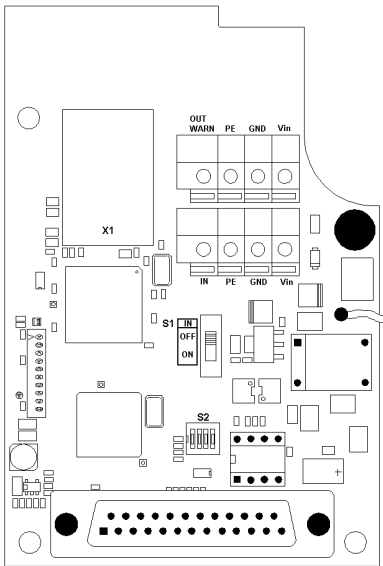

Socket	Function	
X1	RJ-45 socket for 10Base-T or 100Base-TX	
Switch	Position	Function
S2.1	ON	Autonegotiation active (default)
	OFF	Autonegotiation deactivated
S2.2	ON	100 Mbit
	OFF	10 Mbit (default)
S2.3	ON	Full duplex
	OFF	Half duplex (default)
S2.4	ON	Reserved
	OFF	Reserved (default)



Note!

If autonegotiation is active (S2.1 = ON), the position of switches S2.2 and S2.3 is irrelevant. The operating mode is determined automatically.



Attention!

Please observe the notices on cabling in chapter 10.4.

Figure 10.1: Connection circuit board of the Ethernet model

10.2 Ethernet connection - devices with M12 connectors

The electrical connection of the Ethernet is easily performed using M12 connectors. Ready-made connection cables in a variety of lengths are available as accessories for the Ethernet connection (see chapter 14 "Accessories").

For all M12 device models, the connection is made via the left, D-coded connector **BUS IN** (see figure 10.2).

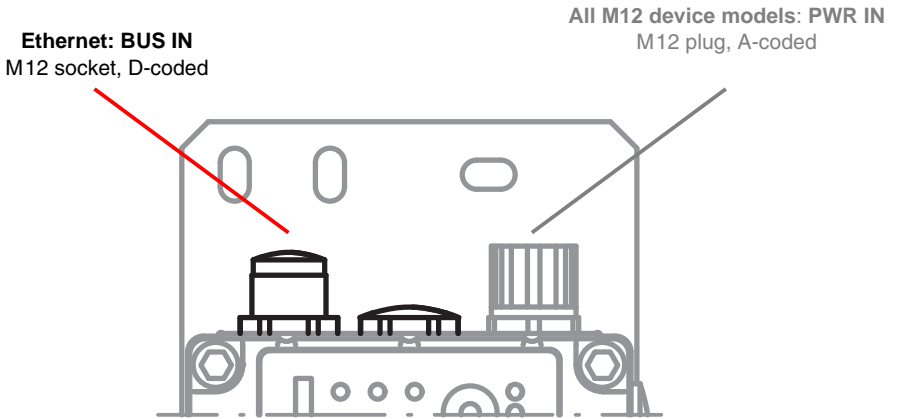

Figure 10.2: Location and designation of the M12 Ethernet connections

BUS IN (4-pin M12 socket, D-coded)			
BUS IN	Pin	Name	Remark
<p>M12 socket (D-coded)</p>	1	TD+	Transmit Data +
	2	RD+	Receive Data +
	3	TD-	Transmit Data -
	4	RD-	Receive Data -
	SH (thread)	FE	Functional earth (housing)

Figure 10.3: Assignment M12 connector BUS IN for Ethernet

10.3 Device configuration Ethernet

10.3.1 Autonegotiation (Nway)

If the switch S2.1 of the DDLS 200 is set to ON (default), the device is in autonegotiation mode. This means that the DDLS 200 detects the transmission characteristics of the connected partner unit automatically (10Mbit or 100Mbit, full or half duplex) and adjusts itself accordingly.

If both devices are in autonegotiation mode, they adjust to the highest common denominator.

If a certain transmission type is to be required, the autonegotiation function must be deactivated (S2.1 = OFF). The transmission characteristics can then be set using the switches S2.2 and S2.3.

10.3.2 Transmission rate conversion

Through the use of an optical transmission system, the Ethernet is divided into two segments. Different transmission rates can be used in the physically separated segments. The DDLS 200s then functions as transmission rate converter. During transmission rate conversion, it must be ensured that the bandwidth of the segment with the lower transmission rate is adequate for processing the incoming data.

10.3.3 Network expansion

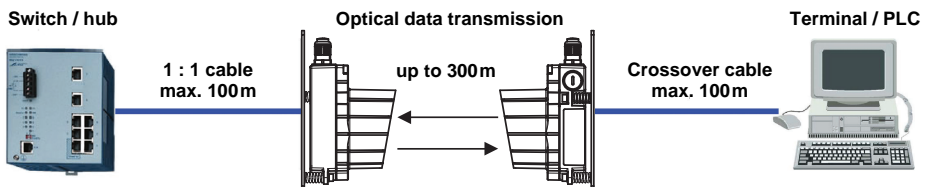

Figure 10.4: Network expansion



Note!

The network expansion of the bus system can be increased through the use of the DDLS 200.

10.4 Wiring



Note!

As shown in figure 10.5 through figure 10.7, a distinction is to be made between a 1 : 1 cable and a "crossover" cable. The "crossover" cable is required whenever the participants (switch, hub, router, PC, PLC, etc.) connected to the DDLS 200 do not provide "autocrossing". If the "autocrossing" function is available in the connected participants, a normal 1 : 1 cable can be used.

DDLS 200 between switch/hub and terminal/PLC

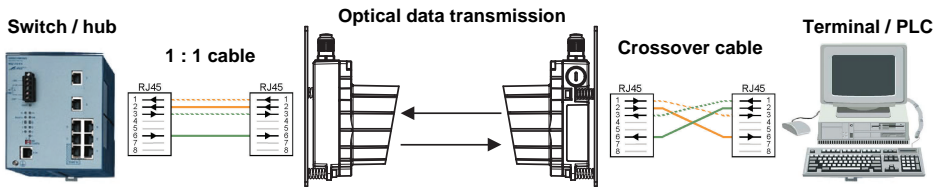

Figure 10.5: DDLS 200 between switch/hub and terminal/PLC



Note!

Make sure that the 1 : 1 cable and crossover cable are connected correctly. Do not plug the 1 : 1 cable to the switch/hub into the "Uplink" port.

DDLS 200 between switch/hub and switch/hub

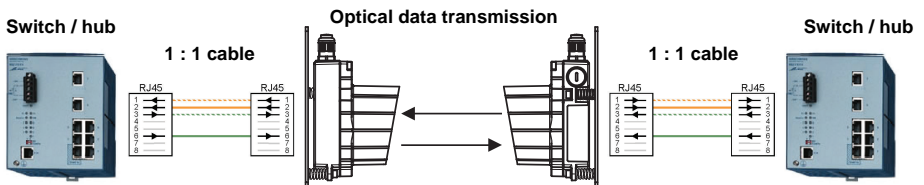

Figure 10.6: DDLS 200 between switch/hub and switch/hub



Note!

Make sure that the 1 : 1 cable and crossover cable are connected correctly. Do not plug the 1 : 1 cable to the switch/hub into the "Uplink" port.

DDLS 200 between terminal/PLC and terminal/PLC

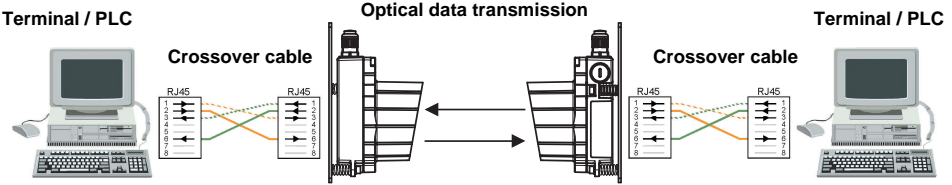

Figure 10.7:DDLS 200 between terminal/PLC and terminal/PLC

10.4.1 Assignment of the RJ45 and M12 Ethernet cables

For the Ethernet models of the DDLS 200, the following pin assignments apply for the RJ45 and M12 connection cables.

RJ45 to RJ45 - 1 : 1

Signal	Function	Core color	Pin RJ45		Pin RJ45
TD+	Transmit Data +	yellow	1 / TD+	<->	1 / TD+
TD-	Transmit Data -	orange	2 / TD-	<->	2 / TD-
RD+	Receive Data +	white	3 / RD+	<->	3 / RD+
RD-	Receive Data -	blue	6 / RD-	<->	6 / RD-

RJ45 to RJ45 - "Crossover"

Signal	Function	Core color	Pin RJ45		Pin RJ45
TD+	Transmit Data +	yellow	1 / TD+	<->	3 / RD+
TD-	Transmit Data -	orange	2 / TD-	<->	6 / RD-
RD+	Receive Data +	white	3 / RD+	<->	1 / TD+
RD-	Receive Data -	blue	6 / RD-	<->	2 / TD-

M12 plug - D-coded with open cable end

Signal	Function	Core color	Pin M12		Strand
TD+	Transmit Data +	yellow	1 / TD+	<->	YE
TD-	Transmit Data -	orange	3 / TD-	<->	OG
RD+	Receive Data +	white	2 / RD+	<->	WH
RD-	Receive Data -	blue	4 / RD-	<->	BU

M12 plug to M12 plug - D-coded

Signal	Function	Core color	Pin M12		Pin M12
TD+	Transmit Data +	yellow	1 / TD+	<->	1 / TD+
TD-	Transmit Data -	orange	3 / TD-	<->	3 / TD-
RD+	Receive Data +	white	2 / RD+	<->	2 / RD+
RD-	Receive Data -	blue	4 / RD-	<->	4 / RD-

M12 plug, D-coded to RJ45 - 1 : 1

Signal	Function	Core color	Pin M12		Pin RJ45
TD+	Transmit Data +	yellow	1 / TD+	<->	1 / TD+
TD-	Transmit Data -	orange	3 / TD-	<->	2 / TD-
RD+	Receive Data +	white	2 / RD+	<->	3 / RD+
RD-	Receive Data -	blue	4 / RD-	<->	6 / RD-

M12 plug, D-coded to RJ45 - "Crossover"

Signal	Function	Core color	Pin M12		Pin RJ45
TD+	Transmit Data +	yellow	1 / TD+	<->	3 / RD+
TD-	Transmit Data -	orange	3 / TD-	<->	6 / RD-
RD+	Receive Data +	white	2 / RD+	<->	1 / TD+
RD-	Receive Data -	blue	4 / RD-	<->	2 / TD-

10.4.2 Installing cable with RJ45 connector

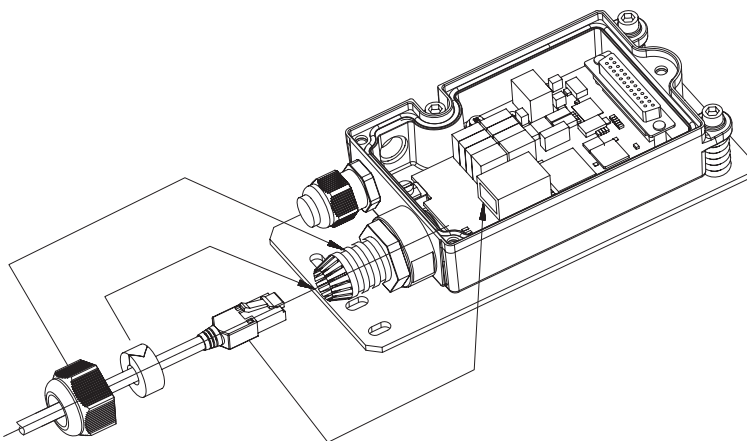
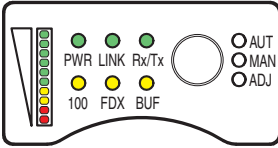

Figure 10.8: Installing cable with RJ45 connector

10.5 LED Indicators Ethernet

In addition to the indicator and operating elements present in all device models (bar graph, buttons, LEDs AUT, MAN, ADJ; see chapter 11.1 "Indicator and operating elements"), the Ethernet model includes the following additional indicators:



LED PWR:	green	=	operating indicator.
	green flashing	=	transmitter /receiver unit switched off via switching input IN or hardware error
	off	=	no operating voltage
LED LINK:	green	=	LINK OK.
	off	=	no LINK present
LED Rx/Tx:	green	=	data are being received by the bus.
	red	=	data are being transmitted to the bus.
	orange	=	data are simultaneously received and transmitted via the bus.
	off	=	no data are being received by the bus or transmitted to the bus
LED 100:	yellow	=	100 Base-Tx connected
	off	=	10Base-T connected
LED FDX:	yellow	=	full duplex (Full-Duplex)
	off	=	half duplex
LED BUF:	yellow	=	internal buffer (Buffer) full, message rejected.
	off	=	message not rejected.

Figure 10.9:Indicator/operating elements for the Ethernet model

10.6 Important notices for system integrators



Attention!

The notices provide initial information and describe the working principles of the optical data transceiver with Ethernet.

The notices must be read by each user before the first commissioning of the DDLS 200 with Ethernet.

Possible restrictions in the timing of the optical data transmission in comparison to copper-based data transmission are described here.

Using the DDLS 200 for Ethernet, 10Base-T or 100Base-TX with 2Mbit is transmitted optically e.g. to a moving rack serving unit where it is then converted back into 10Base-T or 100Base-TX.

The DDLS200 is connected to the Ethernet via a twisted pair port with an RJ45 connector or an M12 connector. An external switch reduces the data flow along the optical transmission path by filtering the messages. Only messages for nodes located downstream of the optical data transmission path are actually transmitted. The data throughput rate of the optical transmission path is max. 2Mbit/s.

10.6.1 Typical bus configuration

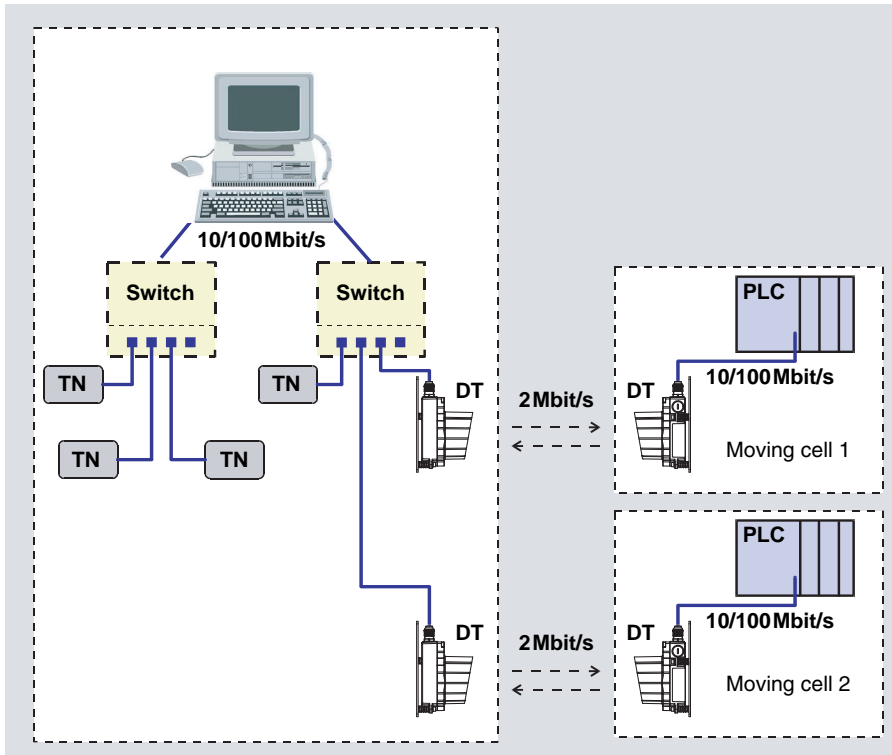

Figure 10.10: Typical Ethernet bus configuration

The optical data path has a maximum data rate of 2Mbit/s in each direction of data transmission. In the network, it must be ensured that the **average** data rate in each direction of transmission is less than or equal to 2Mbit/s. This is, amongst others, achieved by the following measures.

- **Address filtering by upstream switch:**

The upstream switch ensures that only messages for nodes located downstream of the optical data transmission path are transmitted. This leads to a significant reduction in data

- **Receiver buffer:**

Via the 16kByte receiver buffer, brief peak loads can be managed without data loss. If the receiver buffer overflows, the subsequent messages are rejected (dropped).

- **Primary transmission protocol:**

The primary protocol (e.g., TCP/IP) ensures that messages are re-sent if they are lost or have remained unacknowledged. In addition, protocols such as TCP/IP automatically adapt to the available bandwidth of the transmission medium.

10.6.2 Timing

Sequence diagram

Assumption: the host computer wants to transmit a run command to PLC via optical data transmission path (see figure 10.10).

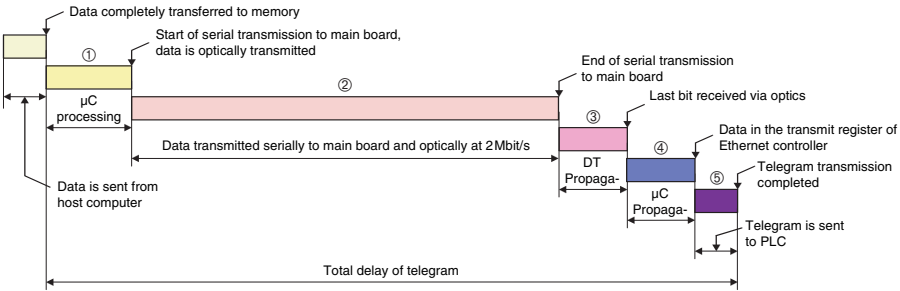

Figure 10.11: Typical Ethernet telegram structure

Description of time segments

Pos.	Description	Time (estimated)		Remark
①	DSP processing time for preparing data to be sent via optical interface	approx. 30µs		Telegrams which are still being sent or still in memory may delay further processing
②	Sending data via optical interface with 2Mbit/s	Number of bits in telegram • 550ns		
③	Delay caused by optical conversion and light propagation time	1.2 µs	2.2 µs	Signal is delayed by approx. 3.3ns per meter of optical transmission path
④	DSP processing of data between optics and writing to Ethernet controller	approx. 30µs		
⑤	Data is sent to PLC	Number of bits in the telegram • 0.1 µs at 10Mbit/s (0.01 µs at 100Mbit/s)		

Signal delay

The typical delay of a message from a DDLS 200 to the opposing DDLS 200 is:

$\text{Number of bits in the telegram} \cdot (0.55\mu\text{s} + T_{\text{bit}}^{1)}) + 60\mu\text{s}$

1) T_{bit} for 10Base-T = 0.10 μs , T_{bit} for 100Base-TX = 0.01 μs



Note!

The maximum delay is dependent on various factors (bus loading, history, ...).

Examples 10Base-T Ethernet

	Minimum telegram (64byte)	Medium telegram (500byte)	Maximum telegram (1,518byte)
Header	18byte	18byte	18byte
Data	46byte	482byte	1,500byte
①	30 μs	30 μs	30 μs
②	282 μs	2,200 μs	6,680 μs
③	Disregarded	Disregarded	Disregarded
④	30 μs	30 μs	30 μs
⑤	52 μs	400 μs	1,214 μs
Total	394μs	2,660μs	7,954μs

Examples 100Base-TX Ethernet

	Minimum telegram (64byte)	Medium telegram (500byte)	Maximum telegram (1,518byte)
Header	18byte	18byte	18byte
Data	46byte	482byte	1,500byte
①	30 μs	30 μs	30 μs
②	282 μs	2,200 μs	6,680 μs
③	Disregarded	Disregarded	Disregarded
④	30 μs	30 μs	30 μs
⑤	5 μs	40 μs	121 μs
Total	347μs	2,300μs	6,861μs

11 Commissioning / Operation (all device models)

11.1 Indicator and operating elements

All DDLS 200 device models have the following indicator and operating elements:

- Bar graph with 10 LEDs
- Operating mode LEDs AUT, MAN, ADJ
- Operating mode buttons

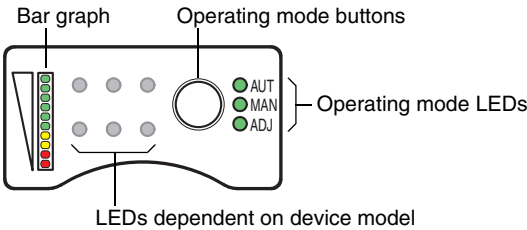

Figure 11.1: Indicator and operating elements common to all DDLS 200 device models

Bar graph

The bar graph displays the quality of the received signal (receiving level) at its own (operating modes "Automatic" and "Manual") or opposing (operating mode "Adjust") DDLS 200 (figure 11.2).

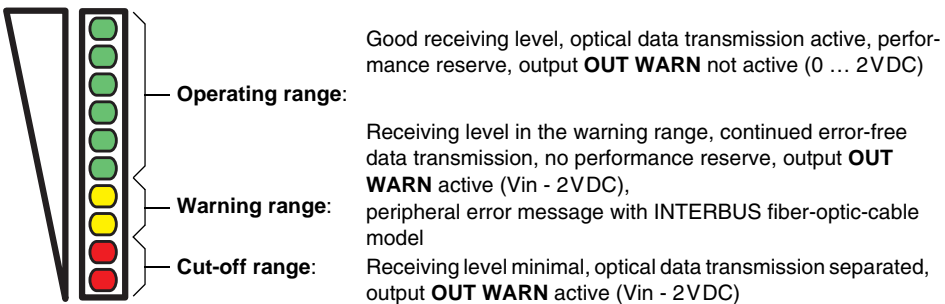

Figure 11.2: Meaning of the bar graph for displaying the receiving level

Operating mode LEDs

The three green LEDs **AUT**, **MAN** and **ADJ** indicate the current operating mode (see chapter 11.2 "Operating modes") of the DDLS 200.

- **AUT**: operating mode "Automatic"
- **MAN**: operating mode "Manual"
- **ADJ**: operating mode "Adjust"

Operating mode buttons

With the operating mode button, you can switch between the three operating modes "Automatic", "Manual" and "Adjust" (see chapter 11.2 "Operating modes").

11.2 Operating modes

The following table provides an overview of the DDLS 200 operating modes.

Operating mode	Description	Optical data transmission	Bar graph assignment
Automatic, AUT LED illuminates	Normal operation	Active	Its own receiving level, display of the alignment quality of the opposing device
Manual, MAN LED illuminates	Adjustment operation, cut-off threshold on higher level	Active	Its own receiving level, display of the alignment quality of the opposing device
Adjust, ADJ LED illuminates	Adjustment operation, cut-off threshold on higher level	Separated	Receiving level of the opposing device, display of the alignment quality of own device

Changing the operating mode

AUT → MAN Press the operating mode button for more than 2 seconds. Only the device on which the button was pressed switches to the "Manual" operating mode (**MAN** LED illuminates).

MAN → ADJ Press the operating mode button on one of the two devices. Both devices switch to the "Adjust" operating mode (both **ADJ** LEDs illuminate) when both were previously in the "Manual" operating mode.

ADJ → MAN Press the operating mode button on one of the two devices. Both devices switch to the "Manual" operating mode (both **MAN** LEDs illuminate).

MAN → AUT Press the operating mode button for more than 2 seconds. Only the device on which the button was pressed switches to the "Automatic" operating mode (**AUT** LED illuminates).



Note!

*If, while in the AUT operating mode, the operating mode button is pressed for longer than 13s, the device switches to a special diagnostic mode. The **AUT**, **MAN** and **ADJ** LEDs illuminate simultaneously (see chapter 13.2 "Diagnostic mode" on page 65).*

To switch to the "Adjust" (ADJ) operating mode, both devices belonging to a transmission path must first be in the "Manual" (MAN) operating mode. It is not possible to switch directly from the "Automatic" to the "Adjust" operating mode or vice versa.

11.3 Initial commissioning

11.3.1 Switch on device / function check

After applying the operating voltage, the DDLS 200 first performs a self-test. If the self-test is successfully completed, the **PWR** or **UL** LED illuminates continuously and the DDLS 200 switches to the "Automatic" operating mode. If the connection to the opposing device exists, data can be transmitted immediately.

If the **PWR** or **UL** LED flashes after switching on, there may be two causes: a hardware error has occurred or the transmitter/receiver unit has been switched off via the **IN** switching input ("Switching input" on page 18).

If the **PWR** or **UL** LED remains dark after switching on, there is either no voltage supply present (check connections and voltage) or a hardware error has occurred.

11.3.2 Fine adjustment

If you have mounted and switched on the two DDLS 200s of a given optical transmission path and they are both in the "Automatic" operating mode, you can perform the fine adjustment of the devices relative to one another with the aid of the three alignment screws.



Note!

Note that with "alignment", the transmitter with the beam which is to be positioned as exactly as possible on the opposing receiver is always meant.

At the maximum sensing distance, the bar graph does not show end-scale deflection even with optimal alignment!

The DDLS 200 supports fast and easy fine adjustment. The **optimization of the alignment** between the two devices of one transmission path can be performed **by just one person**. Use the following descriptive steps as a set of numbered instructions:

1. Both devices are located close to one another (> 1 m). Ideally, the bar graphs of both devices display maximum end-scale deflection.
2. Switch both devices to "Manual" (**MAN**) by pressing the button for a relatively long time (> 2s). Data transmission remains active, only the internal cut-off threshold is changed to the warning threshold (yellow LEDs).
3. While in the "Manual" operating mode, move until data transmission of the DDLS 200 is interrupted. You can normally give the vehicle a run command up to the end of the lane. The vehicle stops immediately upon interruption of data transmission. The devices are not yet optimally aligned with one another.
4. Briefly press the button to switch both devices to the "Adjust" operating mode (**ADJ**). Data transmission remains interrupted.
5. The devices can now be individually aligned. The result of the alignment can be read directly in the bar graph.
6. When both devices are aligned, briefly pressing the button on one of the devices is enough to switch both back to the "Manual" operating mode (**MAN**). Data transmission is again active; the vehicle can continue its path. If data transmission is interrupted again, repeat steps 3 through 6.
7. If the data transmission and the alignment are OK through the end of the path of motion, switch both devices back to the "Automatic" (**AUT**) operating mode by pressing the button for a relatively long time (> 2s). The optical data transceiver is now ready for operation.

11.4 Operation

In running operation ("Automatic" operating mode) the DDLS 200 operates maintenance-free. Only the glass optics need to be cleaned occasionally in the event of soiling. This can be checked by analyzing the switching output **OUT WARN** (with the INTERBUS fiber-optic-cable model, a peripheral error message is also available). If the output is set, soiling of the DDLS 200's glass optics is often the cause (see chapter 12.1 "Cleaning").

It must still be ensured that the light beam is not interrupted at any time.

**Attention!**

If, during operation of the DDLS 200, the light beam is interrupted or one of the two devices is switched voltage free, the effect of the interruption on the entire network is equivalent to the interruption of a data line!

In the event of an interruption (light beam interruption or switched voltage-free), the DDLS 200 switches off the network to a non-interacting state. The system reactions in the event of an interruption are to be defined together with the supplier of the PLC.

12 Maintenance

12.1 Cleaning

The optical window of the DDLS 200 is to be cleaned monthly or as needed (warning output). To clean, use a soft cloth and a cleaning agent (standard glass cleaner).



Attention!

Do not use solvents and cleaning agents containing acetone. Use of improper cleaning agents can damage the optical window.

13 Diagnostics and Troubleshooting

13.1 Status display on the device

The LEDs on the control panel of the DDLS 200 provide information about possible faults and errors. The descriptions of the states of the DDLS 200's LEDs are found for

- all models in chapter 11.1
- the model PROFIBUS / RS 485 in chapter 5.4
- the model INTERBUS 500kbit/s / RS 422 in chapter 6.3
- the model INTERBUS 2Mbit/s fiber-optic cable in chapter 7.3
- the model Data Highway + / Remote I/O in chapter 8.3
- the model DeviceNet / CANopen in chapter 9.5
- the model Ethernet in chapter 10.5



Note!

The INTERBUS 2Mbit/s fiber-optic-cable model of the DDLS 200 is an INTERBUS subscriber (Ident-Code: 0x0C = 12dec). You can also use the diagnostic options available via the INTERBUS.

13.2 Diagnostic mode

In the diagnostic mode, the optical received signal level of the DDLS 200 is monitored. This function is designed to support the diagnosis of short optical light beam interruptions as part of the bus diagnosis.

To enter the diagnostic mode, the DDLS 200 must be in the **AUT** state and the operating mode button must be pressed for longer than 13s. After the button is released, all 3 operating mode LEDs illuminate. If the light beam is interrupted now, the 3 operating mode LEDs start to flash. This state is maintained until the flashing is acknowledged by a brief press of the button. Afterwards, the 3 operating mode LEDs light-up permanently again. To exit the diagnostic mode, the button must be pressed for more than 13s.

Function-wise, the DDLS 200 acts during the diagnosis as if it were in **AUT** state. Hence, just a normal data transmission takes place, and the thresholds for warning and switch-off are also the same as in **AUT** mode.

Each DDLS 200 must individually be set to diagnostic mode. This is in contrast to switching from **MAN** to **ADJ** mode, where both DDLS 200 change to **ADJ** state if one side has its button pressed.

13.3 Troubleshooting

Error	Possible cause	Remedy
PWR or UL LED does not illuminate	<ul style="list-style-type: none"> • No supply voltage • Hardware defect • 	<ul style="list-style-type: none"> • Check connections and supply voltage at the device; switch back on. • In event of defect, replace device and send in for repair.
PWR or UL LED flashes	<ul style="list-style-type: none"> • Transmitter/receiver unit is switched off via input IN. • Hardware defect 	<ul style="list-style-type: none"> • Check input IN and position of switch S1. • In event of defect, replace device and send in for repair.
ADJ LED flashes	<ul style="list-style-type: none"> • Light beam interruption or no visual connection to opposing device (when opposing device is in the "Manual" operating mode). • Misalignment of a DDLS 200 (when opposing device is in the "Manual" operating mode). 	<ul style="list-style-type: none"> • Check light path • Realign transmission path
Bus operation not possible	<ul style="list-style-type: none"> • Transmission error • Wiring error • Adjustment error (termination, baud rate, configuration) • Incorrect bus cable • Transmitter/receiver unit deactivated 	<ul style="list-style-type: none"> • See error "transmission error" • Check wiring • Check settings • Use specified bus cable • Check for correct wiring and S1 position • Set to "Adjust" operating mode, ADJ LED must not flash
Transmission error	<ul style="list-style-type: none"> • Incorrect bus termination • Shielding not connected • Receiving level too low due to <ul style="list-style-type: none"> • Misalignment • Soiling • Operation with excessively large operating ranges • Earth lead not connected • Influenced by parallel data path • Influenced by cascading data paths • Intense, direct ambient light 	<ul style="list-style-type: none"> • Disconnect/connect terminating resistors • Connect shielding correctly • Realign (check in "Adjust" operating mode) • Clean optical window • Observe operating limits • Connect earth lead • Operate data transmission units with alternating frequency assignments, check parallel distances • Operate data transmission units with alternating frequency assignments • Remove ambient light source

14 Accessories

14.1 Accessory terminating resistors

Part No.	Type designation	Remark
50038539	TS 02-4-SO	M12 terminating resistor for PROFIBUS BUS OUT
50040099	TS 01-5-SO	M12 terminating resistor for DeviceNet/CANopen BUS OUT

14.2 Accessory connectors

Part No.	Type designation	Remark
50038538	KD 02-5-BA	M12 connector socket for PROFIBUS BUS IN or SSI interface
50038537	KD 02-5-SO	M12 connector pin for PROFIBUS BUS OUT
50020501	KD 095-5A	M12 connector PWR for voltage supply

14.3 Accessory ready-made cables for voltage supply

14.3.1 Contact assignment of PWR IN connection cable for voltage supply

PWR connection cable (5-pin socket, A-coded)			
	Pin	Name	Core color
<p>PWR OUT WARN 2 1 3 GND 4 FE IN M12 socket (A-coded)</p>	1	Vin	brown
	2	OUT WARN	white
	3	GND	blue
	4	IN	black
	5	FE	grey
	Thread	FE	bright

14.3.2 Technical data of PWR IN connection cable for voltage supply

Operating temperature range in rest state: -30°C ... +70°C
in motion: -5°C ... +70°C

Material sheathing: PVC

Bending radius > 50 mm

14.3.3 Order codes of PWR IN connection cable for voltage supply

Part No.	Type designation	Remark
50104557	K-D M12A-5P-5m-PVC	M12 socket for PWR, axial connector, open line end, cable length 5m
50104559	K-D M12A-5P-10m-PVC	M12 socket for PWR, axial connector, open line end, cable length 10m

14.4 Accessory ready-made cables for interface connection

14.4.1 General

- Cable **KB PB...** for connecting to the BUS IN/BUS OUT M12 connector
- Cable **KB ET...** for connecting to Industrial Ethernet via M12 connector
- Standard cables available in lengths from 2 ... 30m
- Special cables on request.

14.4.2 Contact assignment for PROFIBUS connection cable KB PB...

PROFIBUS connection cable (5-pin socket/connector, B-coded)			
	Pin	Name	Core color
 <p>M12 socket (B-coded)</p>  <p>M12 plug (B-coded)</p>	1	N.C.	–
	2	A (N)	green
	3	N.C.	–
	4	B (P)	red
	5	N.C.	–
	Thread	FE	bright
			

Figure 14.1: Cable structure of PROFIBUS connection cable

14.4.3 Technical data for PROFIBUS connection cable KB PB...

Operating temperature range in rest state: -40°C ... +80°C
 in motion: -5°C ... +80°C

Material The lines fulfill the Profibus requirements,
 free of halogens, silicone and PVC

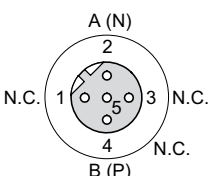
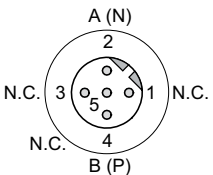
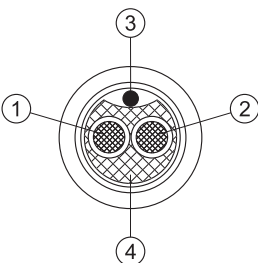
Bending radius > 80mm, suitable for drag chains

14.4.4 Order codes for M12 PROFIBUS connection cables KB PB...

Part No.	Type designation	Remark
50104181	KB PB-2000-BA	M12 socket for BUS IN, axial connector, open line end, cable length 2m
50104180	KB PB-5000-BA	M12 socket for BUS IN, axial connector, open line end, cable length 5m
50104179	KB PB-10000-BA	M12 socket for BUS IN, axial connector, open line end, cable length 10m
50104178	KB PB-15000-BA	M12 socket for BUS IN, axial connector, open line end, cable length 15m
50104177	KB PB-20000-BA	M12 socket for BUS IN, axial connector, open line end, cable length 20m
50104176	KB PB-25000-BA	M12 socket for BUS IN, axial connector, open line end, cable length 25m
50104175	KB PB-30000-BA	M12 socket for BUS IN, axial connector, open line end, cable length 30m
50104188	KB PB-2000-SO	M12 plug for BUS OUT, axial connector, open line end, cable length 2m
50104187	KB PB-5000-SA	M12 plug for BUS OUT, axial connector, open line end, cable length 5m
50104186	KB PB-10000-SA	M12 plug for BUS OUT, axial connector, open line end, cable length 10m
50104185	KB PB-15000-SA	M12 plug for BUS OUT, axial connector, open line end, cable length 15m
50104184	KB PB-20000-SA	M12 plug for BUS OUT, axial connector, open line end, cable length 20m
50104183	KB PB-25000-SA	M12 plug for BUS OUT, axial connector, open line end, cable length 25m
50104182	KB PB-30000-SA	M12 plug for BUS OUT, axial connector, open line end, cable length 30m
50104096	KB PB-1000-SBA	M12 plug + M12 socket for PROFIBUS, axial connectors, cable length 1m
50104097	KB PB-2000-SBA	M12 plug + M12 socket for PROFIBUS, axial connectors, cable length 2m
50104098	KB PB-5000-SBA	M12 plug + M12 socket for PROFIBUS, axial connectors, cable length 5m
50104099	KB PB-10000-SBA	M12 plug + M12 socket for PROFIBUS, axial connectors, cable length 10m
50104100	KB PB-15000-SBA	M12 plug + M12 socket for PROFIBUS, axial connectors, cable length 15m
50104101	KB PB-20000-SBA	M12 plug + M12 socket for PROFIBUS, axial connectors, cable length 20m
50104174	KB PB-25000-SBA	M12 plug + M12 socket for PROFIBUS, axial connectors, cable length 25m
50104173	KB PB-30000-SBA	M12 plug + M12 socket for PROFIBUS, axial connectors, cable length 30m

14.4.5 Contact assignment for M12 Ethernet connection cable KB ET...

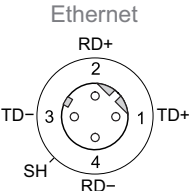
M12 Ethernet connection cable (4-pin plug, D-coded, on both sides)			
 <p>Ethernet RD+ 2 TD- 3 1 TD+ SH 4 RD- M12 plug (D-coded)</p>	Pin	Name	Core color
	1	TD+	yellow
	2	RD+	white
	3	TD-	orange
	4	RD-	blue
SH (thread)	FE	bright	

	Core colors WH YE BU OG
	Conductor class: VDE 0295, EN 60228, IEC 60228 (Class 5)

Figure 14.2: Cable structure of Industrial Ethernet connection cable

14.4.6 Technical data for M12 Ethernet connection cable KB ET...

Operating temperature range in rest state: -50°C ... +80°C
 in motion: -25°C ... +80°C
 in motion: -25°C ... +60°C (drag-chain operation)

Material Cable sheath: PUR (green), wire insulation: PE foam,
 free of halogens, silicone and PVC

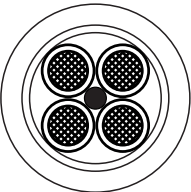
Bending radius > 65mm, suitable for drag chains
Bending cycles > 10⁶, permissible acceleration < 5m/s²

14.4.7 Order codes for M12 Ethernet connection cables KB ET...

Part No.	Type designation	Remark
M12 plug - open cable end		
50106738	KB ET - 1000 - SA	M12 plug for BUS IN, axial connector, open line end, cable length 1m
50106739	KB ET - 2000 - SA	M12 plug for BUS IN, axial connector, open line end, cable length 2m
50106740	KB ET - 5000 - SA	M12 plug for BUS IN, axial connector, open line end, cable length 5m
50106741	KB ET - 10000 - SA	M12 plug for BUS IN, axial connector, open line end, cable length 10m
50106742	KB ET - 15000 - SA	M12 plug for BUS IN, axial connector, open line end, cable length 15m
50106743	KB ET - 20000 - SA	M12 plug for BUS IN, axial connector, open line end, cable length 20m
50106745	KB ET - 25000 - SA	M12 plug for BUS IN, axial connector, open line end, cable length 25m
50106746	KB ET - 30000 - SA	M12 plug for BUS IN, axial connector, open line end, cable length 30m
M12 plug - M12 plug		
50106898	KB ET - 1000 - SSA	2 x M12 plug for BUS IN, axial connectors, cable length 1m
50106899	KB ET - 2000 - SSA	2 x M12 plug for BUS IN, axial connectors, cable length 2m
50106900	KB ET - 5000 - SSA	2 x M12 plug for BUS IN, axial connectors, cable length 5m
50106901	KB ET - 10000 - SSA	2 x M12 plug for BUS IN, axial connectors, cable length 10m
50106902	KB ET - 15000 - SSA	2 x M12 plug for BUS IN, axial connectors, cable length 15m
50106903	KB ET - 20000 - SSA	2 x M12 plug for BUS IN, axial connectors, cable length 20m
50106904	KB ET - 25000 - SSA	2 x M12 plug for BUS IN, axial connectors, cable length 25m
50106905	KB ET - 30000 - SSA	2 x M12 plug for BUS IN, axial connectors, cable length 30m

100Base-TX	50
10Base-T	50

A

Accessories	67
Air humidity	9
Alignment	11
Ambient light	8
Autonegotiation	50, 52
Autopolarity	50

B

Baud rate conversion	41
Bus configuration	57
Bus length	41
Bus transceiver	36

C

Cable	10, 67
CANopen	35
Cascading	14, 33
Cleaning	64
Commissioning	60
Configuration	12
Connection compartment	17
Connector	67
Conversion to M12 connectors	22, 38

D

Data Highway	32
Data transmission system	4
Declaration of conformity	4
DeviceNet	35
DH+	32
Diagnostics	34, 65
Dimensioned drawing	10
Display elements	8

E

Electrical connection	16
Electrical data	8
EMC	9
Ethernet	50
Ethernet connection cable	70

Explanation of symbols	4
------------------------------	---

F

Fiber-optic cable	29
FOC	29
Frequency-offset arrangement	12
FSMA connector	29
Function check	62
Functional earth	17

H

Housing	8
---------------	---

I

Identical frequency arrangement	12
Implementation notes	49
Input	8
Installation	11
Intended use	6
INTERBUS	26, 29

L

LED class	6, 8
LED indicators	
DeviceNet / CANopen	44
DH+ / RIO	34
Ethernet	56
INTERBUS 2Mbit/s Fiber-Optic Cable ..	31
INTERBUS 500kbit/s / RS 422	28
PROFIBUS	25

M

M 12 connector	19
MAC address	50
Maintenance	64
Mechanical data	8
Membrane buttons	8
Modbus	50
Model variations	5
Mounting	11
Multi-master bus system	14

N

Network expansion52
 Noise9
 Nway 50, 52

O

Opening angle 8, 11
 Operating principle5
 Operating temperature9
 Optical axis 10, 11
 Optical data8
 Optical radiation6
 Output8

P

PROFIBUS21
 PROFIBUS connection cable68
 ProfiNet50
 Protection class8
 PWR IN19

R

Remote I/O32
 Repair7
 RIO32
 RS 42226
 RS 48521

S

Safety Notices6
 Sensing distance8
 Series connection14
 Shielding connection27
 Shock9
 Signal delay59
 Status display65
 Storage temperature9
 Supply voltage 17, 20
 Switch on the device62
 Switch S118
 Switching input 18, 20
 Switching output 18, 20
 Synchronous messages49

T

TCP/IP 50
 Technical Data 8
 Connection cable 67
 Terminating resistor 67
 Termination 24, 40, 43
 Timing 48, 58
 Transmission diode 8
 Transmission path 11
 Transmission rate 24
 Transmission rate conversion 52
 Troubleshooting 65, 66

U

UDP 50
 UL 9

V

Vibrations 9

W

Warning signal 18
 Weight 8