



## Sales and Service

### Germany

#### Sales Region North

Phone 07021/573-306  
Fax Int. + 34 93 4097900  
Fax Int. + 34 93 94 9035820

#### Postal code areas

20000-38999  
40000-65999  
97000-97999

#### Sales Region South

Phone 07021/573-307  
Fax Int. + 38 20 19850911

#### Postal code areas

66000-96999

#### Sales Region East

Phone 035027/629-106  
Fax 035027/629-107

#### Postal code areas

01000-19999  
39000-39999  
98000-99999

### Worldwide

#### AR (Argentina)

Condelectric S.A.  
Tel. Int. + 54 1148 361053  
Fax Int. + 54 1148 361053

#### AT (Austria)

Schmachtl GmbH  
Tel. Int. + 43 732 7646-0  
Fax Int. + 43 732 7646-785

#### AU + NZ (Australia + New Zealand)

Balluff/Leuze Pty. Ltd.  
Tel. Int. + 61 3 9720 4100  
Fax Int. + 61 3 9738 2677

#### BE (Belgium)

Leuze electronic nv/sa  
Tel. Int. + 32 2253 16-00  
Fax Int. + 32 2253 15-36

#### BG (Bulgaria)

ATICS  
Tel. Int. + 359 2 847 6244  
Fax Int. + 359 2 847 6244

#### BR (Brazil)

Leuze electronic Ltda.  
Tel. Int. + 55 11 5180-6130  
Fax Int. + 55 11 5180-6141

#### CH (Switzerland)

Leuze electronic AG  
Tel. Int. + 41 41 784 5656  
Fax Int. + 41 41 784 5657

#### CL (Chile)

Imp. Tec. Vignola S.A.I.C.  
Tel. Int. + 56 3235 11-11  
Fax Int. + 56 3235 11-28

#### CN (China)

Leuze electronic Trading  
(Shenzhen) Co. Ltd.  
Tel. Int. + 86 755 862 64909  
Fax Int. + 86 755 862 64901

#### CO (Colombia)

Componentes Electronicas Ltda.  
Tel. Int. + 57 4 3511049  
Fax Int. + 57 4 3511019

#### CZ (Czech Republic)

Schmachtl CZ s.r.o.  
Tel. Int. + 420 244 0015-00  
Fax Int. + 420 244 9107-00

#### DK (Denmark)

Leuze electronic Scandinavia ApS  
Tel. Int. + 45 48 173200

#### ES (Spain)

Leuze electronic S.A.  
Tel. Int. + 34 93 4097900  
Fax Int. + 34 93 94 9035820

#### FI (Finland)

SKS-automatio Oy  
Tel. Int. + 358 20 764-61  
Fax Int. + 358 20 764-6820

#### FR (France)

Leuze electronic Sarl.  
Tel. Int. + 33 160 0512-20  
Fax Int. + 33 160 0503-65

#### GB (United Kingdom)

Leuze electronic Ltd.  
Tel. Int. + 44 14 8040 85-00  
Fax Int. + 44 14 8040 38-08

#### GR (Greece)

UTECO A.B.E.E.  
Tel. Int. + 30 211 1206 900  
Fax Int. + 30 211 1206 999

#### HK (Hong Kong)

Sensortech Company  
Tel. Int. + 852 26510188  
Fax Int. + 852 26510388

#### HR (Croatia)

Tipteh Zagreb d.o.o.  
Tel. Int. + 385 1 381 6574  
Fax Int. + 385 1 381 6577

#### HU (Hungary)

Kvaik Automatika Kft.  
Tel. Int. + 36 1 272 2242  
Fax Int. + 36 1 272 2244

#### ID (Indonesia)

PT. Yabestindo Mitra Utama  
Tel. Int. + 62 21 92861859  
Fax Int. + 62 21 6451044

#### IL (Israel)

Galoz electronics Ltd.  
Tel. Int. + 972 3 9023456  
Fax Int. + 972 3 9021990

#### IN (India)

M + V Marketing Sales Pvt Ltd.  
Tel. Int. + 91 124 4121623  
Fax Int. + 91 124 434223

#### IT (Italy)

Leuze electronic s.r.l.  
Tel. Int. + 39 02 26 1106-43  
Fax Int. + 39 02 26 1106-40

#### JP (Japan)

C. Illies & Co., Ltd.  
Tel. Int. + 81 3 3443 4143  
Fax Int. + 81 3 3443 4118

#### KE (Kenia)

Profa-Tech Ltd.  
Tel. Int. + 254 20 828095/6  
Fax Int. + 254 20 828129

#### KR (South Korea)

Leuze electronic Co., Ltd.  
Tel. Int. + 82 31 3828228  
Fax Int. + 82 31 3828522

#### MK (Macedonia)

Tipteh d.o.o. Skopje  
Tel. Int. + 389 70 399 474  
Fax Int. + 389 23 174 197

#### MX (Mexico)

Motivren S.A.  
Tel. Int. + 52 81 8371 8616  
Fax Int. + 52 81 8371 8588

#### MY (Malaysia)

Ingermah (M) SDN.BHD  
Tel. Int. + 60 360 3427-88  
Fax Int. + 60 360 3421-88

#### NG (Nigeria)

SABROW HI-TECH E. & A. LTD.  
Tel. Int. + 234 80333 86366  
Fax Int. + 234 80333 84463518

#### NL (Netherlands)

Leuze electronic BV  
Tel. Int. + 31 418 65 35-44  
Fax Int. + 31 418 65 38-08

#### NO (Norway)

Elteco A/S  
Tel. Int. + 47 35 56 20-70  
Fax Int. + 47 35 56 20-99

#### PL (Poland)

Balluff Sp. z o. o.  
Tel. Int. + 48 71 338 49 29  
Fax Int. + 48 71 338 49 30

#### PT (Portugal)

LA2P, Lda.  
Tel. Int. + 351 21 4 447070  
Fax Int. + 351 21 4 447075

#### RO (Romania)

O BOYLE s.r.l.  
Tel. Int. + 40 2 56201346  
Fax Int. + 40 2 56221036

#### RS (Republic of Serbia)

Tipteh d.o.o. Beograd  
Tel. Int. + 381 11 3131 057  
Fax Int. + 381 11 3018 326

#### RU (Russian Federation)

ALL IMPEX 2001  
Tel. Int. + 7 495 9213012  
Fax Int. + 7 495 6462092

#### SE (Sweden)

Leuze electronic Scandinavia ApS  
Tel. Int. + 46 380-490951

#### SG + PH (Singapore + Philippines)

Balluff Asia Pte Ltd  
Tel. Int. + 65 6252 43-84  
Fax Int. + 65 6252 90-60

#### SI (Slovenia)

Tipteh d.o.o.  
Tel. Int. + 386 1200 51-50  
Fax Int. + 386 1200 51-51

#### SK (Slovakia)

Schmachtl SK s.r.o.  
Tel. Int. + 421 2 58275600  
Fax Int. + 421 2 58275601

#### TH (Thailand)

Industrial Electrical Co. Ltd.  
Tel. Int. + 66 2 642 6700  
Fax Int. + 66 2 642 4250

#### TR (Turkey)

Leuze electronic San ve Tic.Ltd.Siti.  
Tel. Int. + 90 216 456 6704  
Fax Int. + 90 216 456 3650

#### TW (Taiwan)

Great Colvue Technology Co., Ltd.  
Tel. Int. + 886 2 2983 80-77  
Fax Int. + 886 2 2985 33-73

#### UA (Ukraine)

SV Altera OOO  
Tel. Int. + 38 044 4961888  
Fax Int. + 38 044 4961818

#### US + CA (United States + Canada)

Leuze electronic, Inc.  
Tel. Int. + 1 248 486-4466  
Fax Int. + 1 248 486-6699

#### ZA (South Africa)

Countapulse Controls (PTY).Ltd.  
Tel. Int. + 27 116 1575-56  
Fax Int. + 27 116 1575-13

<b>1</b>	<b>General information</b> .....	<b>6</b>
1.1	Explanation of symbols.....	6
1.2	Declaration of Conformity .....	6
<b>2</b>	<b>Safety notices</b> .....	<b>7</b>
2.1	General safety notices.....	7
2.2	Safety standards .....	7
2.3	Approved purpose .....	7
2.4	Working safely .....	8
<b>3</b>	<b>Device description</b> .....	<b>9</b>
3.1	About the code readers of the LSIS 22x series.....	9
3.2	Characteristics of the code readers of the LSIS 22x series.....	13
3.3	Device construction.....	14
3.4	Stand-alone connection .....	15
<b>4</b>	<b>Installation and mounting</b> .....	<b>16</b>
4.1	Storage, transportation .....	16
4.2	Mounting the LSIS 22x .....	17
4.2.1	Fastening with M4 screws .....	17
4.2.2	Mounting devices.....	18
4.3	Device arrangement.....	19
4.3.1	Selecting a mounting location.....	19
4.3.2	Determining the reading distance .....	20
4.4	Cleaning.....	20
<b>5</b>	<b>Electrical connection</b> .....	<b>21</b>
5.1	Safety notices for the electrical connection.....	22
5.2	Electrical connection of the LSIS 22x M5M-R1 .....	23
5.2.1	LSIS 222 M5M-R1 - RS 232 interface .....	25
5.2.2	LSIS 223 M5M-R1 - USB interface.....	26
<b>6</b>	<b>Commissioning</b> .....	<b>27</b>
6.1	Starting the LSIS 222 M5M-R1 - RS 232 interface .....	27
6.2	Starting the LSIS 223 M5M-R1 - USB-interface .....	28
6.3	Operating modes .....	28
6.4	LED indicators.....	29

<b>7</b>	<b>Configuration using configuration codes .....</b>	<b>30</b>
<b>7.1</b>	<b>Configuration of interface .....</b>	<b>30</b>
7.1.1	RS 232 parameter - LSIS 222 M5M-R1 .....	30
7.1.2	USB parameter - LSIS 223 M5M-R1 .....	33
<b>7.2</b>	<b>Configuration of the reading gate control (trigger) .....</b>	<b>34</b>
7.2.1	Manual/serial trigger mode .....	35
7.2.2	Presentation mode .....	37
7.2.3	Streaming presentation mode .....	38
<b>7.3</b>	<b>Configuration of the reading properties .....</b>	<b>39</b>
7.3.1	Reading the same code multiple times .....	39
7.3.2	Reading multiple different codes in one reading gate .....	40
7.3.3	Restricting the read field (centering) .....	41
7.3.4	Reading inverted bar codes (video reverse) .....	43
7.3.5	Reading codes on LED displays (mobile phone read mode) .....	44
<b>7.4</b>	<b>Configuring input / output .....</b>	<b>45</b>
7.4.1	Prefix / suffix (framing) .....	45
7.4.2	NoRead output .....	47
<b>7.5</b>	<b>Configuring decoding (code selection) .....</b>	<b>48</b>
7.5.1	Code selection of all supported code types .....	49
7.5.2	Codabar code selection .....	50
7.5.3	Code 39 code selection .....	51
7.5.4	Code 32 Pharmaceutical code selection (PARAF) .....	53
7.5.5	Interleaved 2/5 code selection .....	54
7.5.6	Code 93 code selection .....	56
7.5.7	Code 128 code selection .....	57
7.5.8	GS1-128 code selection .....	58
7.5.9	UPC-A code selection .....	59
7.5.10	UPC-E0 code selection .....	60
7.5.11	UPC-E1 code selection .....	60
7.5.12	EAN/JAN-13 code selection .....	61
7.5.13	EAN/JAN-8 code selection .....	62
7.5.14	GS1 DataBar Omnidirectional code selection .....	63
7.5.15	GS1 DataBar Limited code selection .....	63
7.5.16	GS1 DataBar Expanded code selection .....	64
7.5.17	PDF417 code selection .....	65
7.5.18	MicroPDF417 code selection .....	66
7.5.19	GS1 Composite code selection .....	67
7.5.20	QR Code code selection .....	68
7.5.21	Data Matrix code selection .....	69
7.5.22	MaxiCode code selection .....	70
7.5.23	Aztec Code code selection .....	71

<b>7.6</b>	<b>Service codes</b> .....	<b>72</b>
7.6.1	Code ID prefix .....	72
7.6.2	Decoder revision .....	74
7.6.3	Software revision .....	74
7.6.4	Reset to factory settings .....	75
<b>8</b>	<b>Configuration using online commands</b> .....	<b>76</b>
<b>9</b>	<b>Diagnostics and troubleshooting</b> .....	<b>77</b>
9.1	State signaling via LED .....	77
<b>10</b>	<b>Type overview and accessories</b> .....	<b>78</b>
10.1	Type overview LSIS 22x .....	78
10.2	Mounting device accessories .....	78
10.3	Ready-made cable accessories .....	78
10.3.1	Connection cables .....	78
10.3.2	Connection cables (8-pin, socket - open cable ends) .....	79
10.3.3	Connector, user-configurable, not shielded .....	79
<b>11</b>	<b>Maintenance</b> .....	<b>80</b>
11.1	General maintenance information .....	80
11.2	Repairs, servicing .....	80
11.3	Disassembling, packing, disposing .....	80
<b>12</b>	<b>Specifications</b> .....	<b>81</b>
12.1	General specifications of the code readers .....	81
12.2	Dimensioned drawing .....	82
<b>13</b>	<b>Appendix</b> .....	<b>83</b>
13.1	Declaration of conformity .....	83
13.2	ASCII character set .....	84
13.3	Sample codes .....	88
13.3.1	Bar codes module 0.3 .....	88
13.3.2	Bar codes module 0.5 .....	89
13.3.3	Other sample codes .....	90
13.4	Programming codes for the configuration .....	92

Figure 3.1:	Application example: omnidirectional reading of 1D-codes.....	11
Figure 3.2:	Application example: reading 1D-codes in automatic handling machines.....	11
Figure 3.3:	Application example: reading 2D-codes in presentation mode .....	12
Figure 3.4:	Application example: reading of 2D-codes in intralogistics .....	12
Figure 3.5:	Device construction .....	14
Figure 3.6:	Stand-alone connection.....	15
Figure 4.1:	Device name plate LSIS 22x .....	16
Figure 4.2:	Fastening options using M4 threaded holes .....	17
Figure 4.3:	BT 8-0 mounting device.....	18
Figure 4.4:	BTU 300M - D... mounting device.....	19
Figure 4.5:	Reading distance as a function of resolution/code type .....	20
Figure 5.1:	Location of the electrical connection .....	21
Figure 5.2:	Connections of the LSIS 22x.....	23
Figure 5.3:	External wiring of the switching input .....	24
Figure 5.4:	External wiring of the switching output .....	24
Figure 5.5:	RS 232 pin assignments.....	25
Figure 5.6:	USB pin assignment.....	26
Figure 6.1:	LEDs of the LSIS 22x.....	29
Figure 7.1:	Configuration code RS 232 standard parameters .....	30
Figure 7.2:	Configuration codes RS 232 baud rate .....	31
Figure 7.3:	Configuration codes RS 232 data format .....	32
Figure 7.4:	Configuration code USB standard parameters (keyboard emulation) .....	33
Figure 7.5:	Configuration code for USB COM port emulation.....	33
Figure 7.6:	Configuration codes for setting the manual/serial trigger mode .....	35
Figure 7.7:	Configuration code for setting the read time-out time.....	35
Figure 7.8:	Example: Setting a read time-out time of 5 seconds .....	36
Figure 7.9:	Configuration code for setting the presentation mode.....	37
Figure 7.10:	Configuration code for setting the hands free time-out time.....	37
Figure 7.11:	Configuration codes for setting the streaming presentation mode .....	38
Figure 7.12:	Configuration codes for setting the reread delay time .....	39
Figure 7.13:	Configuration code for setting the read time-out time.....	40
Figure 7.14:	Configuration codes for switching the multiple read option on/off .....	40
Figure 7.15:	Restricting the read field with the centering option.....	41
Figure 7.16:	Configuration codes for switching the centering option on/off.....	42
Figure 7.17:	Configuration code for switching the video reverse option on and off .....	43
Figure 7.18:	Configuration codes for switching-on the mobile phone read mode option.....	44
Figure 7.19:	Configuration codes for setting the prefix .....	45
Figure 7.20:	Configuration codes for setting the prefix.....	46
Figure 7.21:	Configuration code for switching the NoRead output option on/off .....	47
Figure 7.22:	Configuration codes for activating/deactivating all code types.....	49
Figure 7.23:	Configuration codes for activating/deactivating the Codabar code type.....	50
Figure 7.24:	Configuration codes for activating/deactivating the Code 39 code type .....	51
Figure 7.25:	Configuration codes for handling the check character with Code 39 .....	52
Figure 7.26:	Configuration codes for activating/deactivating the Code 32 Pharmaceutical code type .....	53
Figure 7.27:	Configuration codes for activating/deactivating the Interleaved 2/5 code type.....	54
Figure 7.28:	Configuration codes for handling the check character with Code Interleaved 2/5.....	55
Figure 7.29:	Configuration codes for activating/deactivating the Code 93 code type .....	56
Figure 7.30:	Configuration codes for activating/deactivating the Code 128 code type.....	57

Figure 7.31:	Configuration codes for activating/deactivating the GS1-128 code type.....	58
Figure 7.32:	Configuration codes for activating/deactivating the UPC-A code type.....	59
Figure 7.33:	Configuration codes for activating/deactivating the UPC-E0 code type.....	60
Figure 7.34:	Configuration codes for activating/deactivating the UPC-E1 code type.....	60
Figure 7.35:	Configuration codes for activating/deactivating the EAN/JAN-13 code type.....	61
Figure 7.36:	Configuration codes for activating/deactivating the EAN/JAN-8 code type.....	62
Figure 7.37:	Configuration codes for activating/deactivating the GS1 DataBar Omnidirectional code type....	63
Figure 7.38:	Configuration codes for activating/deactivating the GS1 DataBar Limited code type.....	63
Figure 7.39:	Configuration codes for activating/deactivating the GS1 DataBar Expanded code type.....	64
Figure 7.40:	Configuration codes for activating/deactivating the PDF417 code type.....	65
Figure 7.41:	Configuration codes for activating/deactivating the MicroPDF417 code type.....	66
Figure 7.42:	Configuration codes for activating/deactivating the GS1 Composite code type.....	67
Figure 7.43:	Configuration codes for activating/deactivating the QR Code code type.....	68
Figure 7.44:	Configuration codes for activating/deactivating the Data Matrix code type.....	69
Figure 7.45:	Configuration codes for activating/deactivating the MaxiCode code type.....	70
Figure 7.46:	Configuration codes for activating/deactivating the Aztec Code code type.....	71
Figure 7.47:	Service code for temporarily transmitting the code ID as prefix.....	72
Table 7.1:	Code IDs of the code types for the LSIS 22x.....	72
Figure 7.48:	Service code for outputting the revision number of the decoder hardware.....	74
Figure 7.49:	Service code for outputting the revision number of the decoder software.....	74
Figure 7.50:	Service code for resetting to factory settings.....	75
Table 9.1:	LED states.....	77
Table 10.1:	Type overview LSIS 22x.....	78
Table 10.2:	Mounting devices for the LSIS 22x.....	78
Table 10.3:	Connection cables for LSIS 222 M5M-R1.....	78
Table 10.4:	Connection cables for LSIS 223 M5M-R1.....	78
Table 10.5:	Pin assignments KB M 12/8-...-BA.....	79
Table 10.6:	Connection cable for the LSIS 22x.....	79
Table 10.7:	Connectors for the LSIS 22x.....	79
Table 12.1:	Specifications of the LSIS 22x M5M-R1 code reader.....	81
Figure 12.1:	Dimensioned drawing code reader LSIS 22x.....	82
Figure 13.1:	Bar code sample (module 0.3).....	88
Figure 13.2:	Bar code sample (module 0.5).....	89
Figure 13.3:	Sample codes.....	90
Figure 13.4:	Sample codes.....	91
Figure 13.5:	Programming codes for configuration.....	92
Figure 13.6:	Programming codes for configuration.....	93

## 1 General information

### 1.1 Explanation of symbols

The symbols used in this technical description are explained below.



**Attention!**

*This symbol precedes text messages which must strictly be observed. Failure to comply with this information results in injuries to persons or damage to the equipment.*



**Notice!**

*This symbol indicates text passages containing important information.*

### 1.2 Declaration of Conformity

The code readers of the LSIS 22x series have been developed and manufactured in accordance with the applicable European standards and directives.



**Notice!**

*You can find the Declaration of Conformity of the devices in chapter 13.1 on page 83.*

The manufacturer of the product, Leuze electronic GmbH & Co. KG in D-73277 Owen, possesses a certified quality assurance system in accordance with ISO 9001.





## 2 Safety notices

### 2.1 General safety notices

#### **Documentation**

All entries in this technical description must be heeded, in particular the present chapter "Safety notices". Keep this technical description in a safe place. It should be available at all times.

#### **Safety regulations**

Observe the locally applicable regulations and the rules of the employer's liability insurance association.

#### **Repair**

Repairs must only be carried out by the manufacturer or an authorized representative.

### 2.2 Safety standards

The code readers of the LSIS 22x series were developed, manufactured and tested in accordance with the applicable safety standards. They correspond to the state of the art.

### 2.3 Approved purpose



#### **Attention!**

*The protection of personnel and the device cannot be guaranteed if the device is operated in a manner not complying with its intended use.*

Code readers of the LSIS 22x series are designed for all applications involving industrial code reading of 1- and 2-dimensional codes, e.g., in storage and materials handling.

In particular, unauthorized uses include:

- in rooms with explosive atmospheres
- operation for medical purposes

## 2.4 Working safely

**Attention!**

*Access to or changes on the device, except where expressly described in this operating manual, is not authorized.*

**Safety regulations**

Observe the locally applicable legal regulations and the rules of the employer's liability insurance association.

**Qualified personnel**

Mounting, commissioning and maintenance of the device must only be carried out by qualified personnel.

Electrical work must be carried out by a certified electrician.

**Notice!**

*The code readers of the LSIS 22x family conform with the free group acc.to EN 62471:2008. Illumination systems of the free group pose no photobiological danger.*

### **3 Device description**

#### **3.1 About the code readers of the LSIS 22x series**

Code readers of the LSIS 22x series perform numerous tasks in industrial code reading such as:

- automatic handling and testing machines
- manual reading by having the worker hold up the code
- automatic reading in robot systems
- reading stationary codes
- in analysis automation
- part traceability with code labels
- reading moving codes
- omnidirectional reading of bar codes

Code readers from the LSIS 22x 2 series are available with various interface models:

- LSIS 222 M5M-R1 with RS 232 interface
- LSIS 223 M5M-R1 with USB interface

The extensive options for device configuration using configuration codes enable adaptation to a multitude of reading tasks.

**Functions overview**

<b>Features</b>	<b>LSIS 222 ...</b>	<b>LSIS 223 ...</b>
<b>General performance characteristics</b>		
Sturdy metal housing	X	X
RS 232 interface	X	
Voltage supply 10 ... 30VDC	X	
USB interface		X
Voltage supply 5VDC		X
<b>1D-code reading</b>		
1D-codes (Code 39, Code 128, Interleaved 2/5, Codabar, EAN/UPC, GS1 128, GS1 Databar, among others)	X	X
Omnidirectional reading	X	X
Multiple code reading	X	X
<b>2D-code reading</b>		
2D-codes (Data Matrix Code ECC 200, Aztec, QR Code, PDF417, Micro PDF, Composite codes and similar)	X	X
Omnidirectional reading	X	X
Multiple code reading	X	X

*1D-code reading application examples*

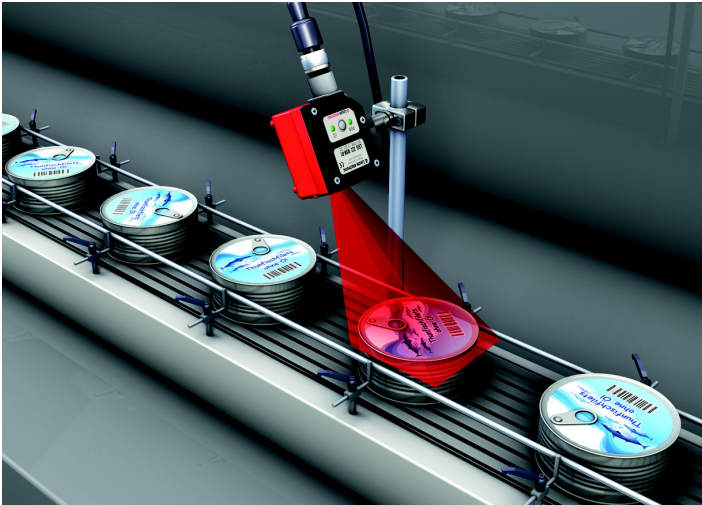

Figure 3.1: Application example: omnidirectional reading of 1D-codes

Figure 3.1 shows the omnidirectional reading of 1D-codes.



Figure 3.2: Application example: reading 1D-codes in automatic handling machines

Figure 3.2 shows the reading of 1D-codes in automatic handling machines.

*2D-code reading application examples*



Figure 3.3: Application example: reading 2D-codes in presentation mode

Figure 3.3 shows the reading of 2D-codes in presentation mode.

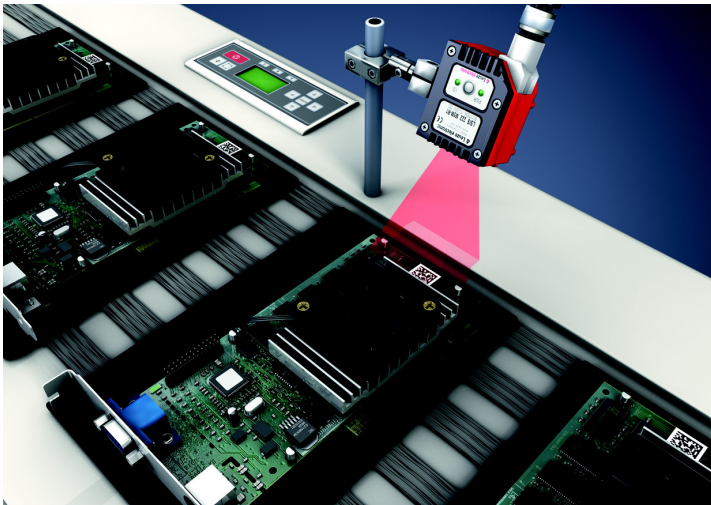

Figure 3.4: Application example: reading of 2D-codes in intralogistics

Figure 3.4 shows the reading of 2D-codes in intralogistics.

## 3.2 Characteristics of the code readers of the LSIS 22x series

### **Performance characteristics:**

- Diverse mounting options with dovetail technology or mounting threads on the rear, bottom and narrow side of the device.
- Integrated red LED illumination for homogeneous illumination of the rectangular field of view.
- Green target LED (aimer) for perfect alignment on the code.
- Trigger button for manual triggering.
- Adjustment of all device parameters via configuration codes.  
No additional software needs to be installed.
- M12 connection.
- 1 switching input for activation (trigger).
- 1 switching output for the signaling of states.
- Heavy-duty housing of protection class IP 65.



### **Notice!**

*Information on technical data and characteristics can be found in chapter 12.1 on page 81.*

### **General information**

Code reading occurs by actuating the trigger button, by a trigger signal at the switching input, by a trigger command via the serial interface and in the permanent reading mode (presentation mode).

Two LEDs provide optical information on the current operating state of the device.

The read code contents are output via the serial interface and, depending on device, RS 232 or USB (either keyboard emulation or COM port emulation).

A switching input **SWI** and a switching output **SWO** control, e.g., the triggering of the LSIS 22x or the communication with external devices such as a PLC.

### 3.3 Device construction

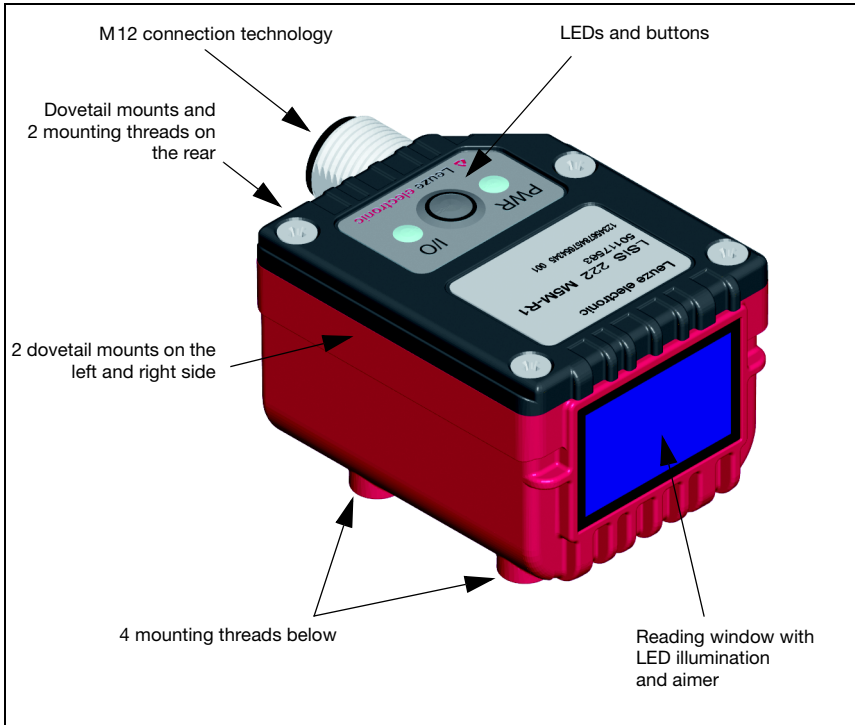

Figure 3.5: Device construction



### 3.4 Stand-alone connection

The code readers of the LSIS 22x series can be operated as individual "stand alone" devices. The LSIS 22x features an 8-pin M12 connector for the electrical connection of the supply voltage, the interface and the switching input and output. The connector can be turned 90°, thereby allowing cables to be laid optimally even in constrained spaces.

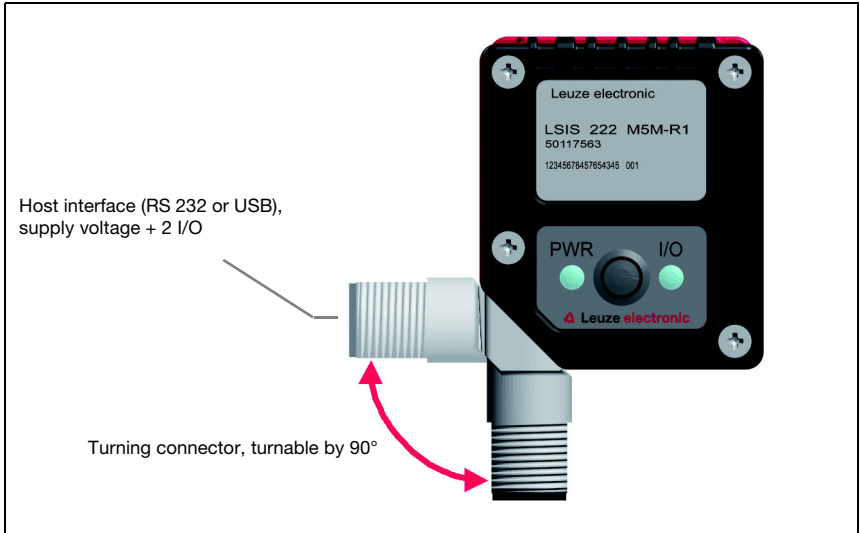

Figure 3.6: Stand-alone connection

Typically, the configuration codes are used to configure the LSIS 22x. Configuration via online commands is also possible.

The switching input and output are used for reading-gate control and for signaling successful reading.

The LSIS 22x can exchange data with the host computer via the RS 232 or USB interface. The framing protocol used for this purpose can be adapted to the specific application. With the USB interface, keyboard emulation is also possible.

## 4 Installation and mounting

### 4.1 Storage, transportation



#### Attention!

When transporting or storing, package the device so that it is protected against collision and humidity. Optimal protection is achieved when using the original packaging. Heed the required environmental conditions specified in the technical data.

#### Unpacking

- ↳ Check the packaging for any damage. If damage is found, notify the post office or shipping agent as well as the supplier.
- ↳ Check the delivery contents using your order and the delivery papers:
  - Delivered quantity
  - Device type and model as indicated on the name plate
  - Package insert

The name plate provides information as to what LSIS type your device is. For specific information, please refer to chapter 10.

#### Name plates of the code readers of the LSIS 22x series

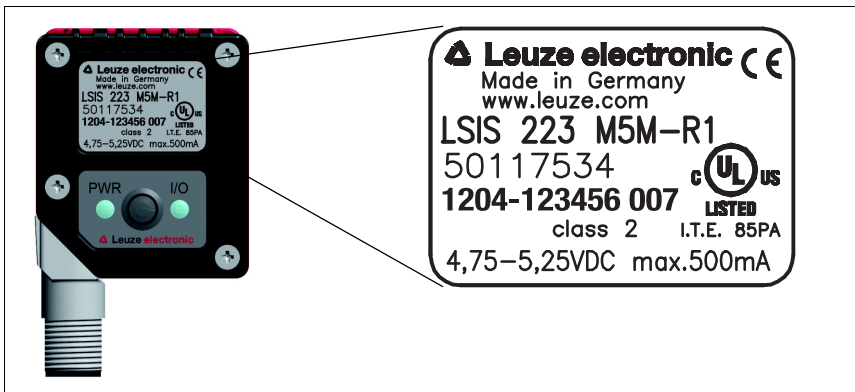

Figure 4.1: Device name plate LSIS 22x

- ↳ Save the original packaging for later storage or shipping.

If you have any questions concerning your shipment, please contact your supplier or your local Leuze electronic sales office.

- ↳ Observe the applicable local regulations when disposing of the packaging materials.

## 4.2 Mounting the LSIS 22x

The LSIS 22x code readers can be mounted in various ways:

- Via four M4 mounting threads on the bottom of the device
- Via two M4 mounting threads on the rear side of the device
- Via three dovetail mounts on the housing sides and the sensor back.

Appropriate mounting devices are available for all types of fastening.

### 4.2.1 Fastening with M4 screws

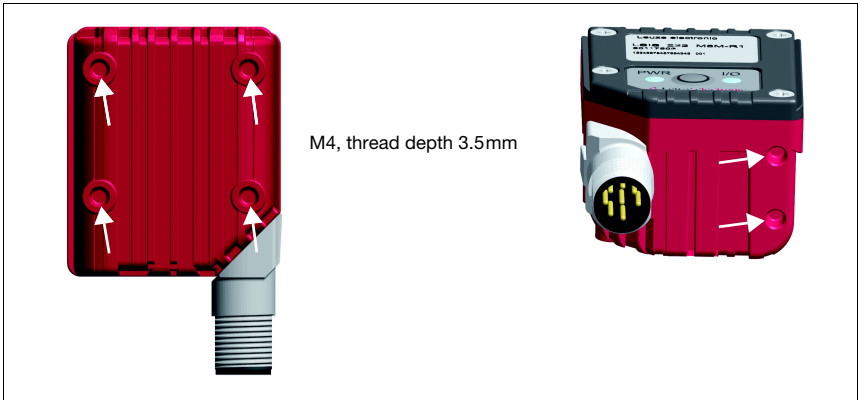

Figure 4.2: Fastening options using M4 threaded holes



**Notice!**

*Dimensioned drawing can be found in chapter 12.2 on page 82.*

#### 4.2.2 Mounting devices

The following mounting devices are available for fastening the LSIS 22x to the dovetail fittings:

- **BT 8-0** mounting block for dovetail (part no. 50036196)
- **BTU 300M - D10** through hole fastening for rod D = 10 mm or cheek 1.5 ... 4 mm (part no. 50117253)
- **BTU 300M - D12** through hole fastening for rod D = 12 mm or cheek 1.5 ... 4 mm (part no. 50117252)
- **BTU 300M - D14** through hole fastening for rod D = 14 mm or cheek 1.5 ... 4 mm (part no. 50117251)

#### *BT 8-0 mounting device*

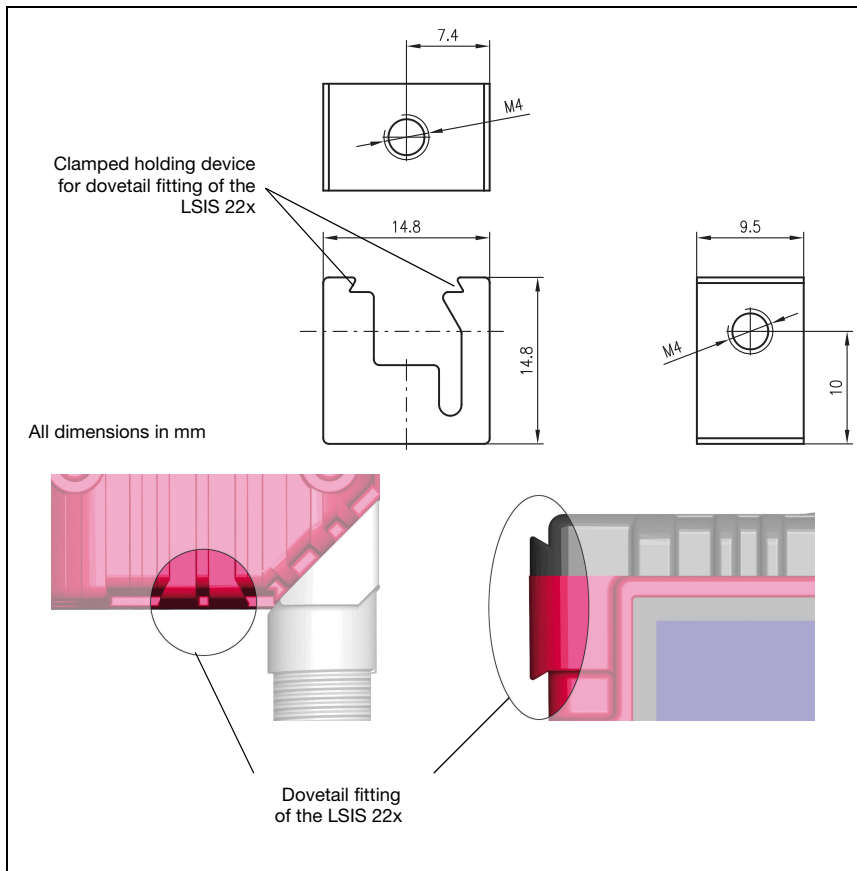

Figure 4.3: BT 8-0 mounting device

**BTU 300M - D... mounting device**

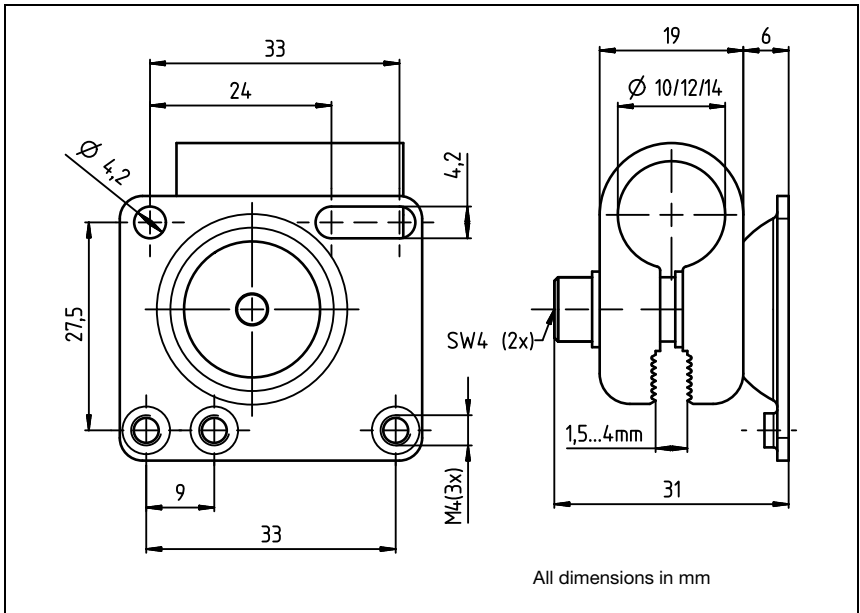

Figure 4.4: BTU 300M - D... mounting device

### 4.3 Device arrangement

#### 4.3.1 Selecting a mounting location

In order to select the right mounting location, several factors must be considered:

- The reading distance resulting from the code size and code type (see figure 4.5).
- The permissible cable lengths between the LSIS 22x and the host system depending on which interface is used.
- The control panel with LEDs and trigger button should be very visible and accessible.
- Mount the LSIS 22x so that the codes that are to be read are not exposed to direct sunlight or strong ambient light.

↳ When selecting a mounting location, pay further attention to:

- Maintaining the required environmental conditions (temperature, humidity).
- Possible soiling of the viewing window due to liquids, abrasion by boxes, or packaging-material residues.
- Lowest possible chance of damage to the LSIS 22x by mechanical collision or jammed parts.

### 4.3.2 Determining the reading distance

The typical reading distances are shown in figure 4.5.

In general, the read field increases with the reading distance. This also results in a decrease in the resolution, however.

For reading distances between 100mm and 130mm, particularly homogeneous illumination of the image field is ensured by the integrated illumination.

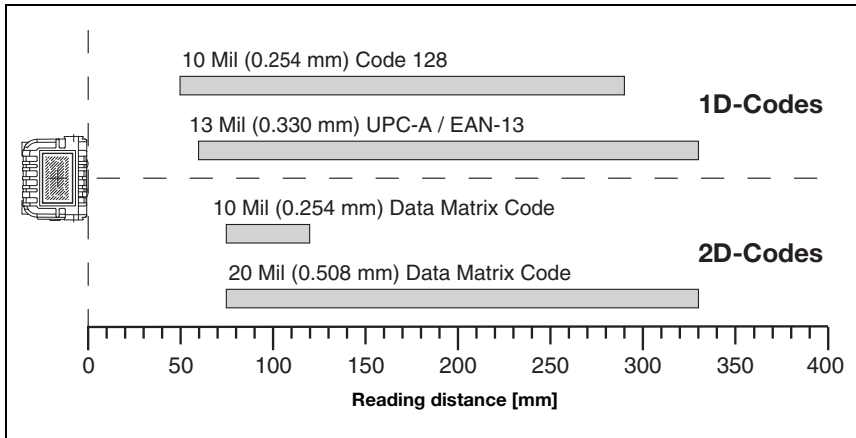

Figure 4.5: Reading distance as a function of resolution/code type



**Notice!**

Please notice that the real reading distances are also influenced by factors such as labeling material, printing quality, scanning angle, printing contrast etc., and may thus deviate from the reading distances specified here.

Depending on code type, code size, cell or modulus size and position of the code in the field of view, reading can also occur while in motion.

### 4.4 Cleaning

 Clean the housing window of the LSIS 22x with a soft cloth after mounting. Remove all packaging remains, e.g. carton fibers or Styrofoam balls. In doing so, avoid leaving fingerprints on the front cover of the LSIS 22x.



**Attention!**

Do not use aggressive cleaning agents such as thinner or acetone for cleaning the device. Use of improper cleaning agents can damage the housing window and display.

## 5 Electrical connection

The code readers of the LSIS 22x series are connected using an 8-pin, A-coded M12 connector.

**Notice!**

Ready-made cables are provided for the 8-pin M12 connection.  
See "Ready-made cable accessories" on page 78.

For order codes, see chapter 10.3 on page 78.



Figure 5.1: Location of the electrical connection

## 5.1 Safety notices for the electrical connection

**Attention!**

*Do not open the device yourself under any circumstances! The housing of the LSIS 22x contains no parts that need to be adjusted or maintained by the user.*

*Before connecting the device please ensure that the supply voltage matches the value printed on the nameplate.*

*Connection of the device and cleaning must only be carried out by a qualified electrician.*

*Ensure that the functional earth (FE) is connected correctly. Unimpaired operation is only guaranteed when the functional earth is connected properly.*

*If faults cannot be corrected, the device should be removed from operation and protected against possible commissioning.*

**Attention!**

*For UL applications, use is only permitted in class 2 circuits in accordance with the NEC (National Electric Code).*



The code readers of the LSIS 22x series are designed in accordance with safety class III for supply by PELV (protective extra-low voltage).

**Notice!**

*Protection class IP 65 is only achieved with screwed-on connector!*



### 5.2 Electrical connection of the LSIS 22x M5M-R1

The LSIS 22x is equipped with an A-coded M12 connector.

- The **voltage supply** (10 ... 30VDC) is connected at **pin 1** and **pin 3 (VB, GND)**.
- The **switching input** is connected at **pin 2 (SWI)**.
- The **switching output** is connected at **pin 4 (SWO)**.
- The **RS 232 interface** is the host interface of the LSIS 222 M5M-R1. It is connected at **pin 6** and **pin 7 (TXD - data, RXD - data)**.
- The **USB interface** is the host interface of the LSIS 223 M5M-R1. It is connected at **pin 6** and **pin 7 (D+ - data, D- - data)**.

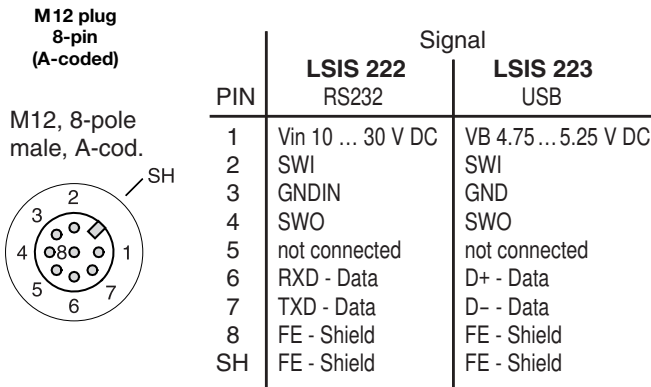

Figure 5.2: Connections of the LSIS 22x

Described in detail in the following are the individual connections.



**Attention!**

Ensure that the functional earth (FE) is connected correctly. Unimpaired operation is only guaranteed when the functional earth is connected properly. Preferably, use the ready-made connection cables from Leuze electronic (see chapter 10.3 on page 78).

Supply voltage



**Attention!**

For UL applications, use is only permitted in class 2 circuits in accordance with the NEC (National Electric Code).



The code readers of the LSIS 22x ... series are designed in accordance with safety class III for supply by PELV (protective extra-low voltage).

### Connecting functional earth FE



#### Attention!

Ensure that the functional earth (FE) is connected correctly. Unimpaired operation is only guaranteed when the functional earth is connected properly. All electrical disturbances (EMC couplings) are discharged via the functional earth connection.

### Switching input/output

The LSIS 22x code readers are equipped with both an opto-decoupled **SWI** switching input and **SWO** switching output.

The LSIS 22x can be activated with the switching input (triggering of code reading).

The switching output is used to signal 'good read' read processes. If a read process is successful, a high pulse **lasting 80 ms** is output at the switching output.

### External wiring of the switching input

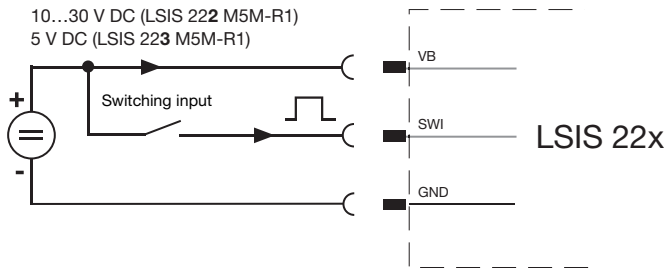

Figure 5.3: External wiring of the switching input

### External wiring of the switching output

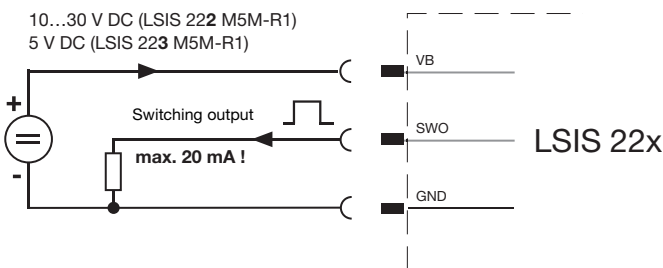

Figure 5.4: External wiring of the switching output



#### Attention!

The switching output is short-circuit proof! However, do not load the switching output of the LSIS 22x with more than 20mA in normal operation!

**5.2.1 LSIS 222 M5M-R1 - RS 232 interface**

The RS 232 interface is used primarily for outputting the read and decoded code contents of the activated code types.



**Notice!**

Preferably, use the ready-made connection cables from Leuze electronic (see chapter 10.3 on page 78).



**Attention!**

Observe the maximum cable length of 10m!

If using self-made cables, observe the following notice:



**Notice for connecting the RS 232 interface!**

Ensure adequate shielding. The entire connection cable must be shielded and earthed.

**RS 232 cable assignments**

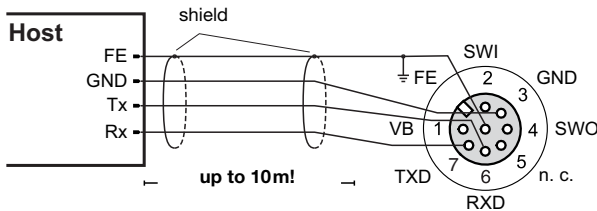

Figure 5.5: RS 232 pin assignments

**MA 2 / MA 4... / MA 2xxi modular interfacing units**

To convert the RS 232 to other interfaces (RS 485, RS 422, ...) or to connect to fieldbus systems (PROFIBUS, PROFINET, Ethernet, etc.), an entire series of Leuze connector units are available .

The **KB JST-M12A-8P-3000** system connection cable (part no. 50111225) can be used to directly connect the LSIS 222 M5M-R1 to these connector units.

**5.2.2 LSIS 223 M5M-R1 - USB interface**

The USB interface is used primarily for outputting the read and decoded code contents of the activated code types.



**Notice!**

Preferably, use the ready-made connection cables from Leuze electronic (see chapter 10.3 on page 78).



**Attention!**

Observe the maximum cable length of 3m!

If using self-made cables, observe the following notice:



**Notice for connecting the USB interface!**

Ensure adequate shielding. The entire connection cable must be shielded and earthed. Use only full-/high-speed data lines acc. to USB 2.0 specifications.

**USB cable assignments**

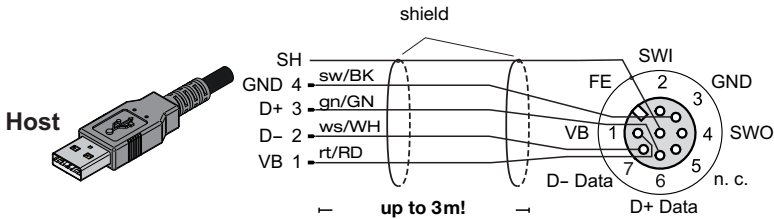

Figure 5.6: USB pin assignment

## 6 Commissioning

### 6.1 Starting the LSIS 222 M5M-R1 - RS 232 interface

Connect the voltage supply and, if applicable, the switching input and the serial interface as described in chapter 5.

**Notice!**

*For the host and LSIS 222 to be able to communicate with one another, the interface parameters (transmission rate, data format) must match!*

**Factory setting LSIS 222:**

- 9600 baud
- 8 data bits
- no parity
- 1 stop bit

Set the host interface to the same parameters as the LSIS 222 or set the LSIS 222 to the same parameters as the host (see chapter 7.1 "Configuration of interface").

Start the Leuze operating software **BCLconfig** on the connected host (PC/terminal) and call up the **terminal function**.

Connect the +10 ... +30VDC supply voltage (typ. +24VDC).

The LSIS 222 starts up; readiness for operation is indicated by the illumination of the green **PWR** LED.

By default, the LSIS 222 is in **manual trigger mode** after switching on for the first time. Press and hold down the trigger button or apply a high signal to the SWI switching input to now activate the code reader (reading gate open). Further information on possible operating modes can be found in chapter 7.1 on page 30.

Hold a sample code in front of the LSIS 222 at a distance of approx. 100mm (see chapter 13.3 "Sample codes" in the appendix). If the read operation is successful, the green alignment aid and red illumination are switched off. The read result is displayed on the screen.

Close the reading gate by releasing the trigger button or, if applied, removing the high signal at the SWI switching input.

## 6.2 Starting the LSIS 223 M5M-R1 - USB-interface

### **USB keyboard emulation**

Connect the voltage supply and, if applicable, the switching input and the USB interface as described in chapter 5.

Start the display software (e.g., **Editor**) on the connected host (PC/terminal).

Connect the +4.75 ... +5.25VDC supply voltage (typ. +5VDC). A Windows driver is installed.

The LSIS 223 starts up; readiness for operation is indicated by the illumination of the green **PWR LED**.

By default, the LSIS 223 is in **streaming presentation mode** (permanent reading) after switching on for the first time; illumination is activated. Further information on possible operating modes can be found in chapter 7.2 on page 37.

Hold a sample code in front of the LSIS 223 at a distance of approx. 100mm (see chapter 13.3 "Sample codes" in the appendix). If the read operation is successful, the I/O LED briefly illuminates green for 80ms. The read result is displayed on the screen.

The LSIS 223 is then immediately again ready for further code readings. The reading gate remains open.



### **Notice!**

*With USB keyboard emulation, data can only be sent in one direction: from the LSIS 22x to the host.*

### **USB COM port emulation**

You can optionally operate the LSIS 223 in the **USB COM port emulation** operating mode without considerable configuration effort. You can then operate the code reader with the **BCLconfig** software; data can be sent bidirectionally.

First install the **USB COM port driver** for the LSIS 223, which you can download from the Leuze home page [www.leuze.com](http://www.leuze.com). Then simply read in the configuration code in figure 7.5 "Configuration code for USB COM port emulation" on page 33.

## 6.3 Operating modes

The LSIS 22x can be configured for various operating modes.

- Manual/serial trigger mode
- Presentation mode
- Streaming presentation mode



### **Notice!**

*The description of the operating modes and instructions on configuring them can be found in chapter 7.2 "Configuration of the reading gate control (trigger)" on page 34.*

### 6.4 LED indicators

The LSIS 22x has two LEDs, **PWR** and **I/O**.



Figure 6.1: LEDs of the LSIS 22x

The LEDs have the following function:

#### **PWR LED**

PWR

● off

PWR

● green continuous light

#### **I/O LED**



green, briefly on (80ms)

I/O

● continuous red light

I/O

● off

#### **Device OFF**

- No supply voltage

#### **Readiness for operation**

- Code reading possible
- Self test successfully finished

#### **Good read, successful reading**

- Code reading successful

#### **Reading gate open**

- Code reading active

#### **No supply voltage**

- No communication possible

## 7 Configuration using configuration codes

The LSIS 22x is configured with the aid of configuration codes. After reading in these codes, the device parameters are set in the device and permanently stored.



**Notice!**

Using Aztec configuration codes, many parameters can be set simultaneously; using 1-dimensional configuration codes, on the other hand, it is generally only possible to set individual parameters.

### 7.1 Configuration of interface

#### 7.1.1 RS 232 parameter - LSIS 222 M5M-R1

By reading in the following configuration code, the RS 232 interface is set to the following standard parameters (factory settings):

- Baud rate **9600bit/s**
- Data format **8 data bits, no parity, 1 stop bit**
- Framing **<STX>DATA<CR><LF>**
- No read character **'?'**
- Manual trigger mode start command: **<SYN>T<CR>**  
stop command: **<SYN>U<CR>**



Figure 7.1: Configuration code RS 232 standard parameters



**Notice!**

The LSIS 222 M5M-R1 and the connected host must be set to the same interface parameters.



By reading in one of the following configuration codes, the RS 232 baud rate can be set. Baud rates from 300 bit/s ... 115.2 kbit/s are available.



Figure 7.2: Configuration codes RS 232 baud rate

By reading in one of the following configuration codes, the RS 232 data format can be set.



Figure 7.3: Configuration codes RS 232 data format



**Notice!**

For further RS 232 settings, please contact Leuze electronic.

**7.1.2 USB parameter - LSIS 223 M5M-R1**

By reading in the following configuration code, the USB interface is set to the following standard parameters for **USB keyboard emulation** (factory setting):

- USB operating mode      **USB keyboard emulation**
- Keyboard layout          **GERMAN**
- Framing                    **'ENTER'**
- No read character        none
- Streaming presentation mode



Figure 7.4: Configuration code USB standard parameters (keyboard emulation)

As an alternative to USB keyboard emulation, **USB COM port emulation** is also possible with the following parameters:

- Framing                    **<STX>DATA<CR><LF>**
- No read character        **'?'**
- Manual trigger mode     start command: **<SYN>T<CR>**  
stop command: **<SYN>U<CR>**

Please read in the following configuration code to set these parameters.



Figure 7.5: Configuration code for USB COM port emulation



**Notice!**

The Windows driver for USB COM port emulation can be found in the download area at [www.leuze.com](http://www.leuze.com).

## 7.2 Configuration of the reading gate control (trigger)

Multiple trigger modes are available for controlling the reading gate (start/stop reading):

- **Manual/serial trigger mode**

- (**factory setting for RS 232 and USB COM port**)

- With manual/serial trigger mode, the reading gate opens if the trigger button is pressed, the trigger input is activated by applying a high signal, or if the **<SYN>T<CR> read start command** is sent to the LSIS 22x via the serial interface. The reading gate closes if a code is read successfully, the trigger button released, the trigger input deactivated by removing the high signal, or if the **<SYN>U<CR> read stop command** is sent to the LSIS 22x via the serial interface.

- With serial trigger (trigger commands via the serial interface), a **read time-out** time can **optionally** be set, after which the reading gate is closed if no code was read.

- **Presentation mode**

- In presentation mode, the LSIS 22x is set to **permanent reading** for ambient light. The reading gate is continuously open. If a change in the image area is detected, the LSIS 22x first tries to read a code. If this is not successful, the intensity of the LED illumination is continuously increased until a code is read. Following the successful reading of a code, the LED illumination is switched off again after a few seconds.

- **Streaming presentation mode**

- (**factory setting for USB keyboard emulation**)

- In streaming presentation mode, the LSIS 22x is set to **permanent reading** with permanently switched-on LED illumination. The reading gate is continuously open.

### **Normal / enhanced mode**

With **manual/serial trigger mode** and with **streaming presentation mode**, a distinction is also made between the **normal** and **enhanced** settings:

- The **normal** setting (factory setting) offers good reading speed at maximum operating range.
- The **enhanced** setting, on the other hand, offers maximum reading speed at a slightly reduced operating range.



#### **Notice!**

*If in doubt, test which setting, **normal** or **enhanced**, delivers the best results in your application.*

### 7.2.1 Manual/serial trigger mode

By reading in one of the following configuration codes, the **manual/serial trigger mode** is set to either the **normal** or **enhanced** variant.



Figure 7.6: Configuration codes for setting the manual/serial trigger mode

#### ***Read time-out for serial trigger***

If the reading gate is to be closed after sending the **<SYN>T<CR> read start command** if no code was read after a defined time, you can set a **read time-out** time. Values can be set in the range **0 ... 300,000ms**.

To do this, first read in the following configuration code and then, digit by digit, the **programming codes** (see "Programming codes for the configuration" on page 92) for the numerical value of the read time-out time in milliseconds. Conclude parameter entry by reading in the **Save** programming code.



Figure 7.7: Configuration code for setting the read time-out time

Shown below is an example illustrating the principle for entering a parameter value.

**Example: Setting a read time-out time of 5 seconds = 5000ms.**

Read in the following codes in the specified order to set the time.



Figure 7.8: Example: Setting a read time-out time of 5 seconds

### 7.2.2 Presentation mode

By reading in the following configuration code, **presentation mode** is set.



Figure 7.9: Configuration code for setting the presentation mode



**Notice!**

*For further optional settings on this parameter, please contact Leuze electronic.*



**Attention!**

***If a trigger occurs by means of a button or trigger input while the LSIS 22x is in presentation mode, the LSIS 22x switches to manual/serial trigger mode!***

*Each time the trigger button is pressed or trigger input is activated, the LSIS 22x is again activated as long as the trigger button is pressed or a high-signal is applied at the trigger input.*

*If no trigger is initiated via the button or the switching input for the duration of the **hands free time-out** time (factory setting: 5s), the LSIS 22x returns to presentation mode.*

*In manual/serial trigger mode, the **hands free time-out** time is not active.*

**Configuring the hands free time-out time**

First read in the following configuration code and then, digit by digit, the **programming codes** (see "Programming codes for the configuration" on page 92) for the numerical value of the hands free time-out time in milliseconds. Conclude parameter entry by reading in the **Save** programming code.

Values can be set in the range **0 ... 300,000ms** (factory setting: 5000ms) .



Figure 7.10: Configuration code for setting the hands free time-out time

### 7.2.3 Streaming presentation mode

By reading in one of the following configuration codes, **streaming presentation mode** is set to either the **normal** or **enhanced** variant.

Streaming presentation mode - normal



Streaming presentation mode - enhanced



Figure 7.11: Configuration codes for setting the streaming presentation mode



#### **Attention!**

***If a trigger occurs by means of a button or trigger input while the LSIS 22x is in presentation mode, the LSIS 22x switches to manual/serial trigger mode!***

*Each time the trigger button is pressed or trigger input is activated, the LSIS 22x is again activated as long as the trigger button is pressed or a high-signal is applied at the trigger input.*

*If no trigger is initiated via the button or the switching input for the duration of the **hands free time-out** time (factory setting: 5s), the LSIS 22x returns to presentation mode.*

*In manual/serial trigger mode, the **hands free time-out** time is not active.*

See "Configuring the hands free time-out time" on page 37.



## 7.3 Configuration of the reading properties

### 7.3.1 Reading the same code multiple times

To prevent the same code from being repeatedly read and output in presentation mode, a **reread delay** delay time can be configured that must elapse before the same code can be read again.

By default, four preset times are available for selection for **reread delay**:

- Short = 500ms
- Medium = 750ms
- Long = 1000ms
- Extra long = 2000ms

By reading in one of the following configuration codes, the **reread delay** time is set to the corresponding value.



Figure 7.12: Configuration codes for setting the reread delay time

If these four preset times are not sufficient, you can define an application-specific time for **reread delay** in the range from 0 ... 30,000ms.

To do this, first read in the following code and then, digit by digit, the **programming codes** (see "Programming codes for the configuration" on page 92) for the numerical value of the reread delay time in milliseconds. Conclude parameter entry by reading in the **Save** programming code.



Figure 7.13: Configuration code for setting the read time-out time

To illustrate the principle of parameter value entry, see example on page 36.

### 7.3.2 Reading multiple different codes in one reading gate

By activating the **multiple read** option, multiple codes can simultaneously be read in one reading gate. The LSIS 22x attempts to find new codes in the read field as long as the reading gate is open. If the option is deactivated (factory setting), the LSIS 22x reads the code that is closest to the target beam and, thus, to the center of the read field.

By reading in one of the following configuration codes, the **multiple read** option is set on or off.



Figure 7.14: Configuration codes for switching the multiple read option on/off

### 7.3.3 Restricting the read field (centering)

The read field of the LSIS 22x has a size of 844 x 640 pixels, shown above in figure 7.15 in gray. If the **centering** option is activated, only codes that are partially or completely within the reading window are read. Thus, code 2 in figure 7.15 is read but code 1 is not read.

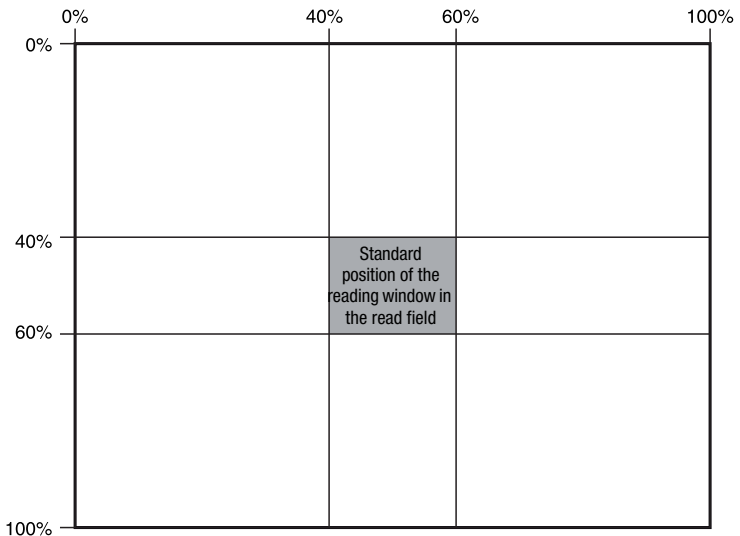
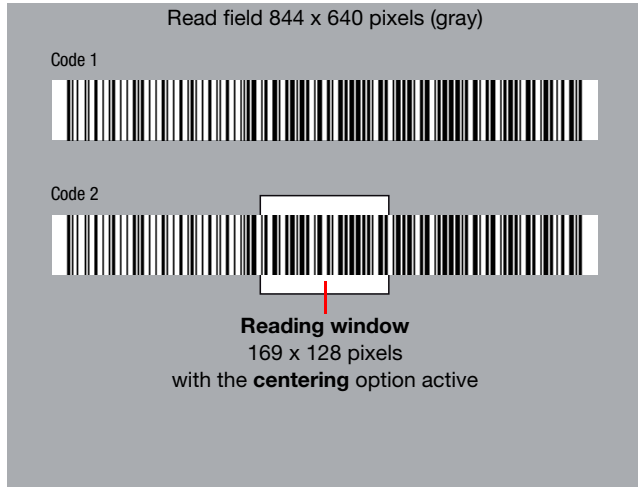

Figure 7.15: Restricting the read field with the centering option

By reading in one of the following configuration codes, the **centering** option is switched on or off.



Figure 7.16: Configuration codes for switching the centering option on/off



**Notice!**

*For a different size/position of the reading window within the read field, please contact Leuze electronic.*

### 7.3.4 Reading inverted bar codes (video reverse)

Activate the **video reverse** option to read inverted bar codes. When activating, you can select whether only inverted codes or both inverted as well as non-inverted codes can be read.

By reading in one of the following configuration codes, the **video reverse** option is switched on or off.

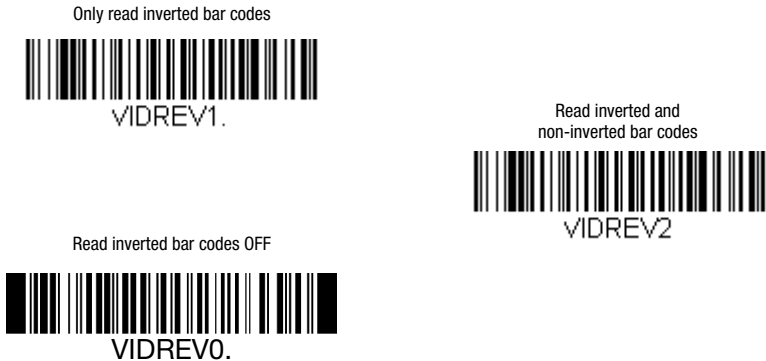

Figure 7.17: Configuration code for switching the video reverse option on and off



**Attention!**

If you activate the option for only reading inverted bar codes, you can then no longer read in **any configuration codes**. To again be able to read in configuration codes, please deactivate the **video reverse** option by reading in the **VIDREV0** code.



**Notice!**

2D-codes can always be read in both inverted **and** non-inverted, regardless of the video reverse option.

### 7.3.5 Reading codes on LED displays (mobile phone read mode)

The decoder of theLSIS 22x can be optimized to read codes on the display of mobile devices such as smartphones or on other LED displays with reflective surfaces. If this option is selected, printed codes may be decoded at a slightly reduced reading speed.

By reading in one of the following configuration codes, the **mobile phone read mode** option in the **manual trigger mode** or **streaming presentation mode** trigger mode is switched on.

To switch off this option, please read in the configuration code for the **manual/serial trigger mode** in the **normal** or **enhanced** variant (see figure 7.6)

Mobile phone read - manual trigger mode



Mobile phone read - streaming presentation mode



Figure 7.18: Configuration codes for switching-on the mobile phone read mode option

## 7.4 Configuring input / output

### 7.4.1 Prefix / suffix (framing)

For communication with the host, the read code information is contained in a message string (frame format). With the LSIS 22x, the frame format has the following structure:

Prefix (1 ... 11 ASCII characters)	Decoded code content	Suffix (1 ... 11 ASCII characters)
------------------------------------	----------------------	------------------------------------

For the prefix and the suffix, the following characters are preset at the factory for all code types:

- **Prefix:** <STX>
- **Suffix:** <CR><LF>

You can set the **prefix** with the following configuration codes.



Figure 7.19: Configuration codes for setting the prefix

Use the following configuration codes to set the **suffix**.



Figure 7.20: Configuration codes for setting the prefix



**Notice!**

With the LSIS 22x, an individual frame format can be defined for each code type. Further information on this topic and on setting other prefix/suffix characters is available from Leuze electronic.



**7.4.2 NoRead output**

You can set whether or not the 'NoRead' character '?' is output if a code could not be read.

Factory settings:

- LSIS 222 M5M-R1 (RS 232) NoRead output = '?'
- LSIS 223 M5M-R1 (USB keyboard emulation) **no** NoRead output
- LSIS 223 M5M-R1 (USB COM port emulation) NoRead output = '?'

By reading in one of the following configuration codes, the **NoRead output** option is switched on or off.



Figure 7.21: Configuration code for switching the NoRead output option on/off

## 7.5 Configuring decoding (code selection)

The LSIS 22x supports nearly all common code types.

For each of the code types listed in the following, you can use configuration codes to individually set whether or not a given code type is to be decoded and output.

In addition, for some codes you can define that only codes with a configured number of digits are output and whether check characters are to be output.

• All code types	<a href="#">chapter 7.5.1</a>	<a href="#">on page 49</a>
• Codabar	<a href="#">chapter 7.5.2</a>	<a href="#">on page 50</a>
• Code 39	<a href="#">chapter 7.5.3</a>	<a href="#">on page 51</a>
• Code 32 pharmaceutical (PARAF)	<a href="#">chapter 7.5.4</a>	<a href="#">on page 53</a>
• Interleaved 2/5	<a href="#">chapter 7.5.5</a>	<a href="#">on page 54</a>
• Code 93	<a href="#">chapter 7.5.6</a>	<a href="#">on page 56</a>
• Code 128	<a href="#">chapter 7.5.7</a>	<a href="#">on page 57</a>
• GS-1-128	<a href="#">chapter 7.5.8</a>	<a href="#">on page 58</a>
• UPC-A	<a href="#">chapter 7.5.9</a>	<a href="#">on page 59</a>
• UPC-E	<a href="#">chapter 7.5.10</a>	<a href="#">on page 60</a>
• UPC-E1	<a href="#">chapter 7.5.11</a>	<a href="#">on page 60</a>
• EAN/JAN-13	<a href="#">chapter 7.5.12</a>	<a href="#">on page 61</a>
• EAN/JAN-8	<a href="#">chapter 7.5.13</a>	<a href="#">on page 62</a>
• GS1 DataBar Omnidirectional	<a href="#">chapter 7.5.14</a>	<a href="#">on page 63</a>
• GS1 DataBar Limited	<a href="#">chapter 7.5.15</a>	<a href="#">on page 63</a>
• GS1 DataBar Expanded	<a href="#">chapter 7.5.16</a>	<a href="#">on page 64</a>
• PDF417	<a href="#">chapter 7.5.17</a>	<a href="#">on page 65</a>
• MicroPDF417	<a href="#">chapter 7.5.18</a>	<a href="#">on page 66</a>
• GS1 Composite	<a href="#">chapter 7.5.19</a>	<a href="#">on page 67</a>
• QR Code	<a href="#">chapter 7.5.20</a>	<a href="#">on page 68</a>
• Data Matrix	<a href="#">chapter 7.5.21</a>	<a href="#">on page 69</a>
• MaxiCode	<a href="#">chapter 7.5.22</a>	<a href="#">on page 70</a>
• Aztec Code	<a href="#">chapter 7.5.23</a>	<a href="#">on page 71</a>



### **Notice!**

*In addition to the common code types listed here, other code types can also be read. For further information, please contact Leuze electronic.*

**7.5.1 Code selection of all supported code types**

By reading in one of the following configuration codes, reading of **all** code types listed in section 7.5 is activated or deactivated.



Figure 7.22: Configuration codes for activating/deactivating all code types



**Notice!**

*Other code types can be read on request.  
For further information, please contact Leuze electronic.*

### 7.5.2 Codabar code selection

By reading in one of the following configuration codes, reading of the **Codabar** code type is activated or deactivated. In addition, it is possible to configure the number of digits that are to be read (value range for number of digits: 2 ... 60, factory setting: 4 ... 60).



Figure 7.23: Configuration codes for activating/deactivating the Codabar code type



**Notice!**

To set the minimum or maximum number of digits, please first read in the above configuration code and then the digits for the desired number of digits (see "Programming codes for the configuration" on page 92). Conclude parameter entry by reading in the **Save** programming code.

For further code settings for the **Codabar** code type, please contact Leuze electronic.

### 7.5.3 Code 39 code selection

By reading in one of the following configuration codes, reading of the **Code 39** code type is activated or deactivated. In addition, it is possible to configure the number of digits that are to be read (value range for number of digits: 0 ... 48, factory setting: 0 ... 48). Also optionally configurable is the check-character evaluation and output.

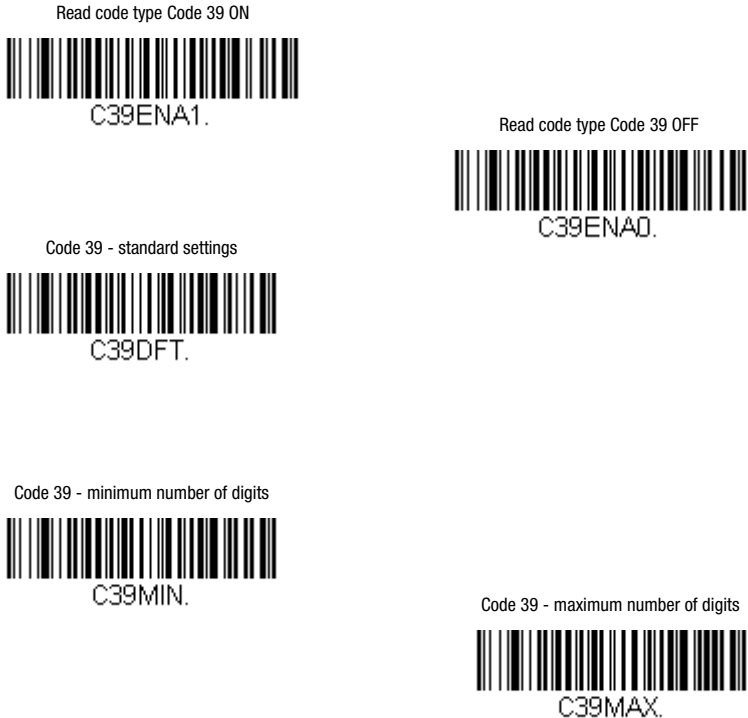

Figure 7.24: Configuration codes for activating/deactivating the Code 39 code type



**Notice!**

To set the minimum or maximum number of digits, please first read in the above configuration code and then the digits for the desired number of digits (see "Programming codes for the configuration" on page 92). Conclude parameter entry by reading in the **Save** programming code.

**Handling of the Code 39 check character**

For the handling of the optional check character present with Code 39, you can make the following settings by reading in one of the following configuration codes:

- **Ignore check character**  
Codes with and without check character are read (factory setting).
- **Evaluate check character but do not transmit**  
Only codes with check character are read. The check character is validated.
- **Evaluate and transmit check character**  
Only codes with check character are read. The check character is validated and output in the message string following the code content.

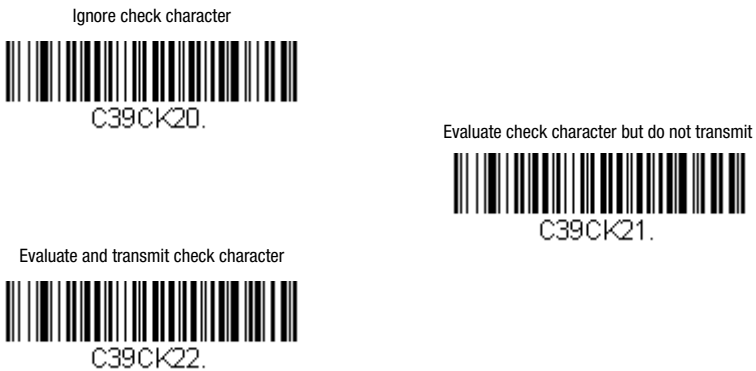

Figure 7.25: Configuration codes for handling the check character with Code 39



**Notice!**

For other code settings for the **Code 39** code type, please contact Leuze electronic.

**7.5.4 Code 32 Pharmaceutical code selection (PARAF)**

By reading in one of the following configuration codes, reading of the **Code 32 Pharmaceutical (PARAF)** code type is activated or deactivated.

Read code type Code 32 Pharmaceutical ON



Read code type Code 32 Pharmaceutical OFF



Figure 7.26: Configuration codes for activating/deactivating the Code 32 Pharmaceutical code type

### 7.5.5 Interleaved 2/5 code selection

By reading one of the following configuration codes, reading of the **Interleaved 2/5** code type is activated or deactivated. In addition, it is possible to configure the number of digits that are to be read (value range for number of digits: 2 ... 80, factory setting: 4 ... 80). Also optionally configurable is the check-character evaluation and output.



Figure 7.27: Configuration codes for activating/deactivating the Interleaved 2/5 code type



**Notice!**

To set the minimum or maximum number of digits, please first read in the above configuration code and then the digits for the desired number of digits (see "Programming codes for the configuration" on page 92). Conclude parameter entry by reading in the **Save** programming code.



**Handling of the Interleaved 2/5 check character**

For the handling of the optional check character present with Code Interleaved 2/5, you can make the following settings by reading in one of the following configuration codes:

- **Ignore check character**  
Codes with and without check character are read (factory setting).
- **Evaluate check character but do not transmit**  
Only codes with check character are read. The check character is validated.
- **Evaluate and transmit check character**  
Only codes with check character are read. The check character is validated and output in the message string following the code content.

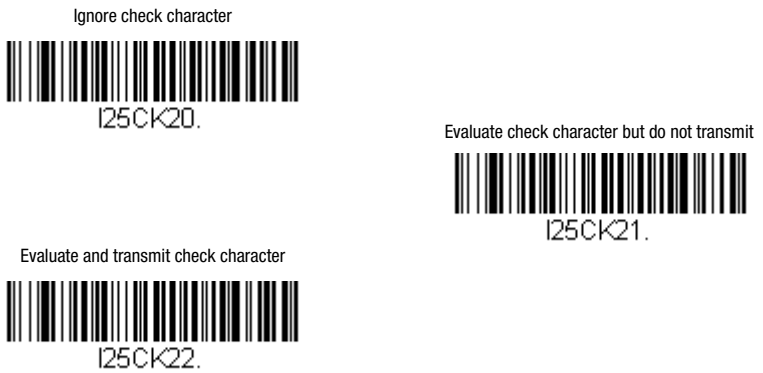

Figure 7.28: Configuration codes for handling the check character with Code Interleaved 2/5

### 7.5.6 Code 93 code selection

By reading in one of the following configuration codes, reading of the **Code 93** code type is activated or deactivated. In addition, it is possible to configure the number of digits that are to be read (value range for number of digits: 0 ... 80, factory setting: 0 ... 80).

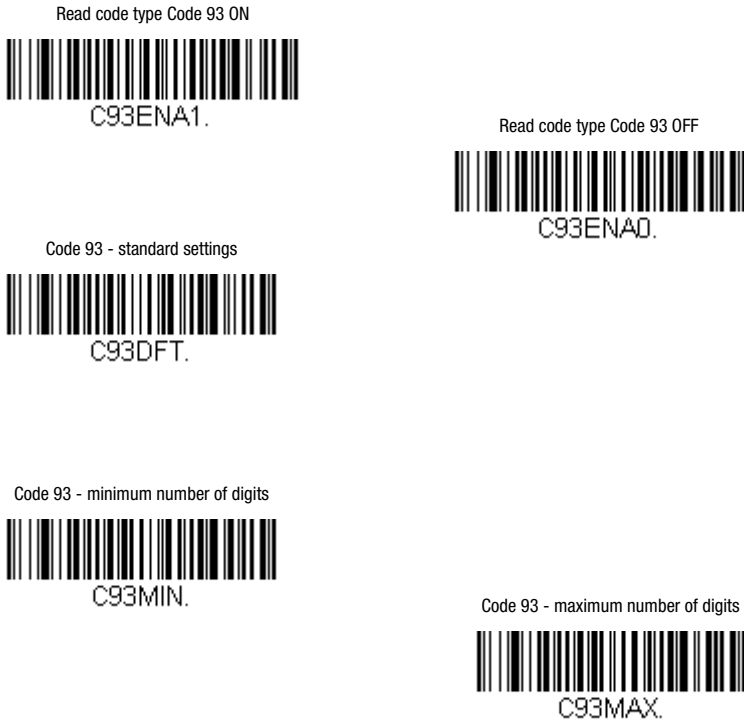

Figure 7.29: Configuration codes for activating/deactivating the Code 93 code type



**Notice!**

To set the minimum or maximum number of digits, please first read in the above configuration code and then the digits for the desired number of digits (see "Programming codes for the configuration" on page 92). Conclude parameter entry by reading in the **Save** programming code.



**Notice!**

For other code settings for the **Code 93** code type, please contact Leuze electronic.

### 7.5.7 Code 128 code selection

By reading in one of the following configuration codes, reading of the **Code 128** code type is activated or deactivated. In addition, it is possible to configure the number of digits that are to be read (value range for number of digits: 0 ... 90, factory setting: 0 ... 90).



Figure 7.30: Configuration codes for activating/deactivating the Code 128 code type



**Notice!**

To set the minimum or maximum number of digits, please first read in the above configuration code and then the digits for the desired number of digits (see "Programming codes for the configuration" on page 92). Conclude parameter entry by reading in the **Save** programming code.



**Notice!**

For other code settings for the **Code 128** code type, please contact Leuze electronic.

### 7.5.8 GS1-128 code selection

By reading in one of the following configuration codes, reading of the **GS1-128** code type is activated or deactivated. In addition, it is possible to configure the number of digits that are to be read (value range for number of digits: 1 ... 80, factory setting: 1 ... 80).



Figure 7.31: Configuration codes for activating/deactivating the GS1-128 code type



**Notice!**

To set the minimum or maximum number of digits, please first read in the above configuration code and then the digits for the desired number of digits (see "Programming codes for the configuration" on page 92). Conclude parameter entry by reading in the **Save** programming code.

**7.5.9 UPC-A code selection**

By reading in one of the following configuration codes, reading of the **UPC-A** code type is activated or deactivated.

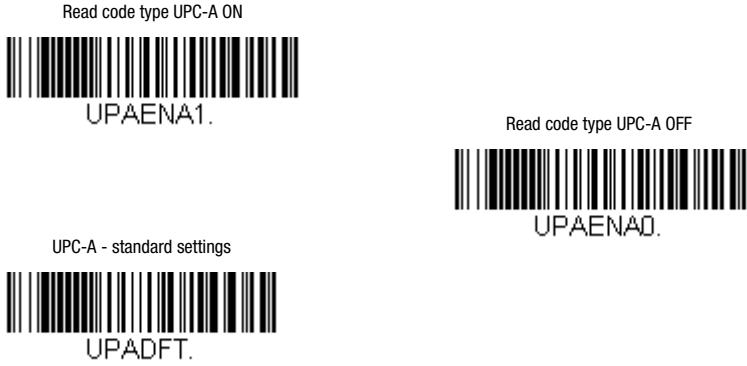

Figure 7.32: Configuration codes for activating/deactivating the UPC-A code type



**Notice!**

*For further code settings for the **UPC-A** code type, please contact Leuze electronic.*

### 7.5.10 UPC-E0 code selection

By reading in one of the following configuration codes, reading of the **UPC-E0** code type is activated or deactivated.

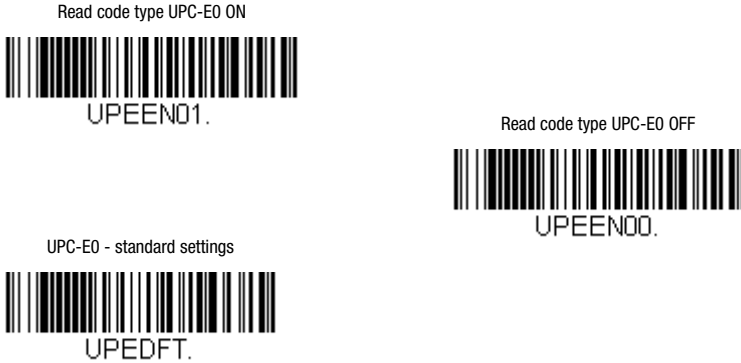

Figure 7.33: Configuration codes for activating/deactivating the UPC-E0 code type



**Notice!**

For further code settings for the **UPC-E0** code type, please contact Leuze electronic.

### 7.5.11 UPC-E1 code selection

By reading in one of the following configuration codes, reading of the **UPC-E1** code type is activated or deactivated.



Figure 7.34: Configuration codes for activating/deactivating the UPC-E1 code type

**7.5.12 EAN/JAN-13 code selection**

By reading in one of the following configuration codes, reading of the **EAN/JAN-13** code type is activated or deactivated.

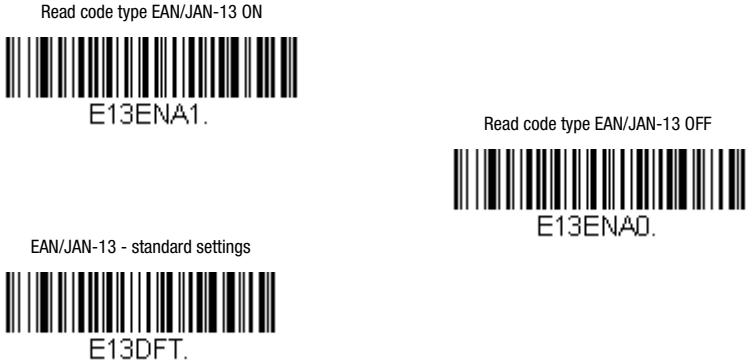

Figure 7.35: Configuration codes for activating/deactivating the EAN/JAN-13 code type



**Notice!**

*For other code settings for the **EAN/JAN-13** code type, please contact Leuze electronic.*

### 7.5.13 EAN/JAN-8 code selection

By reading in one of the following configuration codes, reading of the **EAN/JAN-8** code type is activated or deactivated.

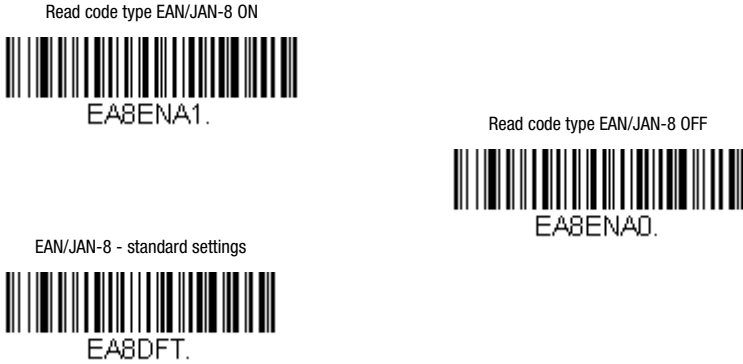

Figure 7.36: Configuration codes for activating/deactivating the EAN/JAN-8 code type



**Notice!**

*For other code settings for the **EAN/JAN-8** code type, please contact Leuze electronic.*



### 7.5.14 GS1 DataBar Omnidirectional code selection

By reading in one of the following configuration codes, reading of the **GS1 DataBar Omnidirectional** code type is activated or deactivated.

Read code type GS1 DataBar Omnidirectional ON



Read code type GS1 DataBar Omnidirectional OFF



GS1 DataBar Omnidirectional -  
standard settings



Figure 7.37: Configuration codes for activating/deactivating the GS1 DataBar Omnidirectional code type

### 7.5.15 GS1 DataBar Limited code selection

By reading in one of the following configuration codes, reading of the **GS1 DataBar Limited** code type is activated or deactivated.

Read code type GS1 DataBar Limited ON



Read code type GS1 DataBar Limited OFF



GS1 DataBar Limited -  
standard settings



Figure 7.38: Configuration codes for activating/deactivating the GS1 DataBar Limited code type

### 7.5.16 GS1 DataBar Expanded code selection

By reading in one of the following configuration codes, reading of the **GS1 DataBar Expanded** code type is activated or deactivated. In addition, it is possible to configure the number of digits that are to be read (value range for number of digits: 4 ... 74, factory setting: 4 ... 74).

Read code type GS1 DataBar Expanded ON



RSEENA1.

Read code type GS1 DataBar Expanded OFF



RSEENA0.

GS1 DataBar Expanded -  
standard settings



RSEDFT.

GS1 DataBar Expanded -  
minimum number of digits



RSEMIN.

GS1 DataBar Expanded -  
maximum number of digits



RSEMAX.

Figure 7.39: Configuration codes for activating/deactivating the GS1 DataBar Expanded code type



**Notice!**

To set the minimum or maximum number of digits, please first read in the above configuration code and then the digits for the desired number of digits (see "Programming codes for the configuration" on page 92). Conclude parameter entry by reading in the **Save** programming code.

7.5.17 PDF417 code selection

By reading in one of the following configuration codes, reading of the **PDF417** code type is activated or deactivated. In addition, it is possible to configure the number of digits that are to be read (value range for number of digits: 1 ... 2750, factory setting: 1 ... 2750).



Figure 7.40: Configuration codes for activating/deactivating the PDF417 code type



**Notice!**

To set the minimum or maximum number of digits, please first read in the above configuration code and then the digits for the desired number of digits (see "Programming codes for the configuration" on page 92). Conclude parameter entry by reading in the **Save** programming code.

### 7.5.18 MicroPDF417 code selection

By reading in one of the following configuration codes, reading of the **MicroPDF417** code type is activated or deactivated. In addition, it is possible to configure the number of digits that are to be read (value range for number of digits: 1 ... 366, factory setting: 1 ... 366).



Figure 7.41: Configuration codes for activating/deactivating the MicroPDF417 code type



**Notice!**

To set the minimum or maximum number of digits, please first read in the above configuration code and then the digits for the desired number of digits (see "Programming codes for the configuration" on page 92). Conclude parameter entry by reading in the **Save** programming code.

**7.5.19 GS1 Composite code selection**

By reading in one of the following configuration codes, reading of the **GS1 Composite** code type is activated or deactivated.



Figure 7.42: Configuration codes for activating/deactivating the GS1 Composite code type



**Notice!**

*For further code settings for the **GS1 Composite** code type, please contact Leuze electronic.*

### 7.5.20 QR Code code selection

By reading in one of the following configuration codes, reading of the **QR Code** code type is activated or deactivated. In addition, it is possible to configure the number of digits that are to be read (value range for number of digits: 1 ... 7089, factory setting: 1 ... 7089).



Figure 7.43: Configuration codes for activating/deactivating the QR Code code type



**Notice!**

To set the minimum or maximum number of digits, please first read in the above configuration code and then the digits for the desired number of digits (see "Programming codes for the configuration" on page 92). Conclude parameter entry by reading in the **Save** programming code.

### 7.5.21 Data Matrix code selection

By reading in one of the following configuration codes, reading of the **Data Matrix** code type is activated or deactivated. In addition, it is possible to configure the number of digits that are to be read (value range for number of digits: 1 ... 3116, factory setting: 1 ... 3116).



Figure 7.44: Configuration codes for activating/deactivating the Data Matrix code type



**Notice!**

To set the minimum or maximum number of digits, please first read in the above configuration code and then the digits for the desired number of digits (see "Programming codes for the configuration" on page 92). Conclude parameter entry by reading in the **Save** programming code.



**Notice!**

For further code settings for the **Data Matrix** code type, please contact Leuze electronic.

### 7.5.22 MaxiCode code selection

By reading in one of the following configuration codes, reading of the **MaxiCode** code type is activated or deactivated. In addition, it is possible to configure the number of digits that are to be read (value range for number of digits: 1 ... 150, factory setting: 1 ... 150).



Figure 7.45: Configuration codes for activating/deactivating the MaxiCode code type



**Notice!**

To set the minimum or maximum number of digits, please first read in the above configuration code and then the digits for the desired number of digits (see "Programming codes for the configuration" on page 92). Conclude parameter entry by reading in the **Save** programming code.



7.5.23 Aztec Code code selection

By reading in one of the following configuration codes, reading of the **Aztec Code** code type is activated or deactivated. In addition, it is possible to configure the number of digits that are to be read (value range for number of digits: 1 ... 3832, factory setting: 1 ... 3832).

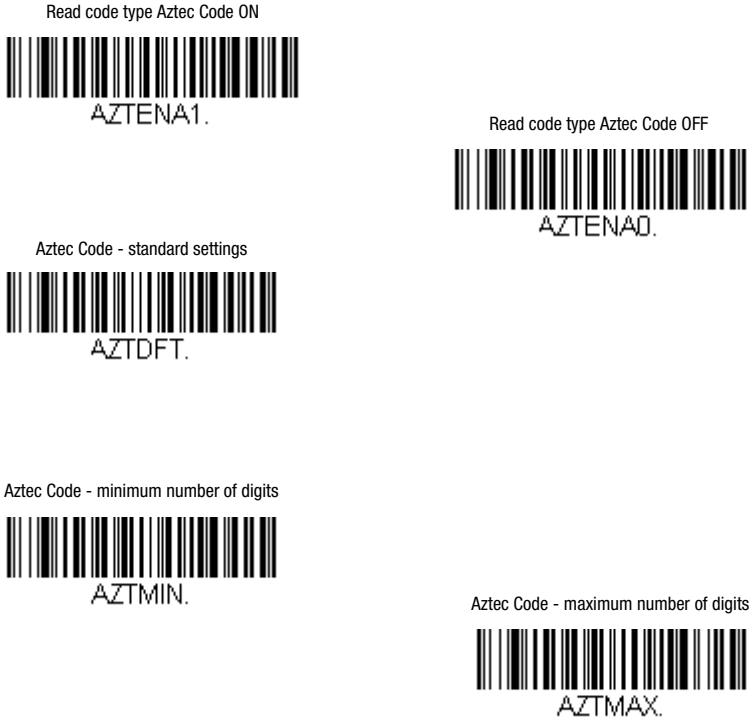

Figure 7.46: Configuration codes for activating/deactivating the Aztec Code code type



**Notice!**

To set the minimum or maximum number of digits, please first read in the above configuration code and then the digits for the desired number of digits (see "Programming codes for the configuration" on page 92). Conclude parameter entry by reading in the **Save** programming code.



**Notice!**

For other code settings for the **Aztec Code** code type, please contact Leuze electronic.

## 7.6 Service codes

### 7.6.1 Code ID prefix

For test purposes, the code ID of the code type of the read code can be transmitted in the message string as a prefix. The existing prefixes are then temporarily deleted and replaced by the code ID as prefix. By reading in the following service code, this function is temporarily activated until the next power-OFF-ON.



Figure 7.47: Service code for temporarily transmitting the code ID as prefix

Listed in the following table are the code IDs of all code types supported by the LSIS 22x.

Code type	Code ID - ASCII	Code ID - hex
all code types		0x99
Australian Post	A	0x41
Aztec Code	z	0x7A
British Post	B	0x42
Canadian Post	C	0x43
China Post	Q	0x51
Chinese Sensible Code (Han Xin Code)	H	0x48
Codabar	a	0x61
Codablock A	V	0x56
Codablock F	q	0x71
Code 11	h	0x68
Code 128	j	0x6A
GS1-128	l	0x49
Code 32 Pharmaceutical (PARAF)	<	0x3C
Code 39 (supports Full ASCII mode)	b	0x62
Code 49	l	0x6C
Code 93 and 93i	i	0x69
Data Matrix	w	0x77
EAN-13 (including Bookland EAN)	d	0x64
EAN-13 with Add-On	d	0x64
EAN-13 with Extended Coupon Code	d	0x64
EAN-8	D	0x44
EAN-8 with Add-On	D	0x44

Table 7.1: Code IDs of the code types for the LSIS 22x

GS1 Composite	y	0x79
GS1 DataBar	y	0x79
InfoMail	,	0x2C
Intelligent Mail Barcode	M	0x4D
Interleaved 2 of 5	e	0x65
Japanese Post	J	0x4A
KIX (Netherlands) Post	K	0x4B
Korea Post	?	0x3F
Matrix 2 of 5	m	0x6D
MaxiCode	x	0x78
MicroPDF417	R	0x52
MSI	g	0x67
NEC 2 of 5	Y	0x59
OCR MICR (E 13 B)	O	0x4F
OCR SEMI Font	O	0x4F
OCR-A	O	0x4F
OCR-B	O	0x4F
PDF417	r	0x72
Planet Code	L	0x4C
Postal-4i	N	0x4E
Postnet	P	0x50
QR Code and Micro QR Code	s	0x73
Straight 2 of 5 IATA	f	0x66
Straight 2 of 5 Industrial	f	0x66
TCIF Linked Code 39 (TLC39)	T	0x54
Telepen	T	0x54
UPC-A	c	0x63
UPC-A with Add-On	c	0x63
UPC-A with Extended Coupon Code	c	0x63
UPC-E	E	0x45
UPC-E with Add-On	E	0x45
UPC-E1	E	0x45

Table 7.1: Code IDs of the code types for the LSIS 22x

### 7.6.2 Decoder revision

By reading in the following service code, the revision number of the decoder hardware is output.

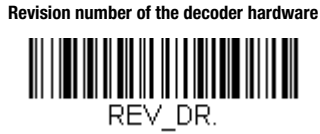

Figure 7.48: Service code for outputting the revision number of the decoder hardware

### 7.6.3 Software revision

By reading in the following service code, the revision number of the decoder software is output.



Figure 7.49: Service code for outputting the revision number of the decoder software

### 7.6.4 Reset to factory settings

By reading in the following service code, the LSIS 22x is reset to factory settings.



**Attention!**

**When resetting to factory settings, the entire configuration of the LSIS 22x is lost and all parameters are reset to their standard values.**



Figure 7.50: Service code for resetting to factory settings

Listed in the following are the most important factory settings according to device model:

**Factory settings LSIS 222 M5M-R1 - RS 232 interface**

- Baud rate **9600bit/s**
- Data format **8 data bits, no parity, 1 stop bit**
- Framing **<STX>DATA<CR><LF>**
- No read character **'?'**
- Manual trigger mode start command: **<SYN>T<CR>**  
stop command: **<SYN>U<CR>**

**Factory settings LSIS 223 M5M-R1 - USB interface**

- USB operating mode **USB keyboard emulation**
- Keyboard layout **GERMAN**
- Framing **'ENTER'**
- No read character none
- Streaming presentation mode

## 8 Configuration using online commands

Configuration can be performed via the RS 232 interface or via the USB interface with COM port emulation with online commands.

### *Examples for online commands*

#### **Example 1:**

To, e.g., configure a <STX> as prefix, the following command string must be sent:

**<SYN>M<CR>PREBK29902.**

The response from the LSIS 22x is:

**PREBK29902<ACK>.**

If an <ENQ> is sent as response, the command syntax was incorrect.

If an <NAK> is sent, the command could not be executed because the permissible value/range was exceeded.



#### **Notice!**

*If no response is received to the sent command, the interface is probably not correctly set.*

#### **Example 2:**

To deactivate Code 128 as a readable code, the following command string must be sent:

**<SYN>M<CR>128ENAO.**

The response from the LSIS 22x is:

**128ENAO<ACK>.**



#### **Notice!**

*The commands correspond to the content of the configuration codes that are printed in this technical description. For further information on the topic of online commands, please contact Leuze electronic.*

## 9 Diagnostics and troubleshooting

### 9.1 State signaling via LED

Error	Possible error causes	Measures
<b>Status LED 'PWR'</b>		
Off	<ul style="list-style-type: none"> <li>No supply voltage connected to the device</li> <li>Hardware error</li> </ul>	<input type="checkbox"/> Check supply voltage <input type="checkbox"/> Send device to customer service
Green continuous light	<ul style="list-style-type: none"> <li>No error</li> </ul>	<input type="checkbox"/> None
<b>Status LED 'IO'</b>		
Off	<ul style="list-style-type: none"> <li>No trigger signal present</li> <li>No decoding</li> </ul>	<input type="checkbox"/> Switching signal for trigger <input type="checkbox"/> No decoding result
Green 0.3s	<ul style="list-style-type: none"> <li>Decoding successful</li> </ul>	<input type="checkbox"/> None
Orange 0.3s	<ul style="list-style-type: none"> <li>Trigger present and decoding was successful</li> </ul>	<input type="checkbox"/> None
Red continuous light	<ul style="list-style-type: none"> <li>Trigger signal present</li> </ul>	<input type="checkbox"/> None
<b>Illumination LED behind the lens cover</b>		
Off	<ul style="list-style-type: none"> <li>No trigger signal</li> <li>No supply voltage</li> <li>No USB connection (LSIS 223... only)</li> </ul>	<input type="checkbox"/> Press button <input type="checkbox"/> Connect voltage <input type="checkbox"/> Establish USB connection and check driver
On	<ul style="list-style-type: none"> <li>Trigger is activated</li> </ul>	<input type="checkbox"/> Hold up code

Table 9.1: LED states



**Notice!**

Please use **chapter 9 as a master copy** should servicing be required.

Cross the items in the "Measures" column which you have already examined, fill out the following address field and fax the pages together with your service contract to the fax number listed below.

**Customer data (please complete)**

<b>Device type:</b>	
<b>Software version :</b>	
<b>Company:</b>	
<b>Customer order number:</b>	
<b>Contact person/ Department:</b>	
<b>Phone (direct):</b>	
<b>Fax:</b>	
<b>Street / No:</b>	
<b>ZIP code/City:</b>	
<b>Country:</b>	

**Leuze Service fax number:**

**+49 7021 573 - 199**

## 10 Type overview and accessories

### 10.1 Type overview LSIS 22x

Type designation	Connection	Interface	Part no.
LSIS 222 M5M-R1	M12 connector	RS 232, 300 ... 115,200 baud	50117536
LSIS 223 M5M-R1	M12 connector	USB 2.0	50117534

Table 10.1: Type overview LSIS 22x

### 10.2 Mounting device accessories

Type designation	Description	Part no.
BT 8-0	Mounting block for dovetail	50036196
BTU 300M - D10	Through hole fastening for rod D = 10 mm or cheek 1.5 ... 4 mm	50117253
BTU 300M - D12	Through hole fastening for rod D = 12 mm or cheek 1.5 ... 4 mm	50117252
BTU 300M - D14	Through hole fastening for rod D = 14 mm or cheek 1.5 ... 4 mm	50117251

Table 10.2: Mounting devices for the LSIS 22x

### 10.3 Ready-made cable accessories

#### 10.3.1 Connection cables

##### *Order codes of the connection cables for LSIS 222 M5M-R1*

Type designation	Description	Part no.
KB JST-M12A-8P-3000	3 m connection cable, M12 socket axial, 8-pin, A-coded, shielded, JST 10/6 system plug for connecting directly to MA 2 / MA 4... / MA 2xxi	50111225
KB M12A-8P-PC-IO-3000	3 m connection cable, M12 socket axial, 8-pin, A-coded, shielded, M12 connector axial, 4-pin + SUB-D9 socket	50111226
KB 034-2000	2 m extension cable, M12 socket axial, 8-pin, A-coded, shielded, M12 connector axial, 8-pin, A-coded	50037543

Table 10.3: Connection cables for LSIS 222 M5M-R1

##### *Order codes of the connection cables for LSIS 223 M5M-R1*

Type designation	Description	Part no.
KB M12A-8P-USB-3000	3 m connection cable, M12 socket axial, 8-pin, A-coded, shielded, type A USB connector	50111227
KB M12A-8P-USB-IO-3000	3 m connection cable, M12 socket axial, 8-pin, A-coded, shielded, M12 connector axial, 4-pin + type A USB connector	50111228

Table 10.4: Connection cables for LSIS 223 M5M-R1



10.3.2 Connection cables (8-pin, socket - open cable ends)

Connection cable (8-pin socket, A-coded)			
	Pin	Name	Core color
 <p><b>M12 socket (A-coded)</b></p>	1	Vin / VB	brown
	2	SWI	white
	3	GNDIN / GND	Blue
	4	SWO	black
	5	n.c.	gray
	6	RXD / D+	pink
	7	TXD / D-	violet
	8	FE	orange
	Thread	FE	bright

Table 10.5: Pin assignments KB M12/8-...-BA

Order codes of the cables

Type designation	Description	Part no.
<b>M12 socket, axial connector, open cable end</b>		
KB M12/8-1000-BA	Cable length 1m	50110170
KB M12/8-2000-BA	Cable length 2m	50110171
KB M12/8-5000-BA	Cable length 5m	50110172
KB M12/8-10000-BA	Cable length 10m	50110173

Table 10.6: Connection cable for the LSIS 22x

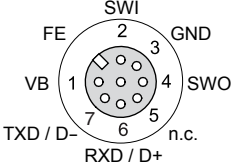

**Notice!**

Operation of the RS 232 host interface is only permissible with shielded cables with maximum cable length of 10m.

Operation of the USB 2.0 host interface is only permissible with shielded cables with maximum cable length of 3m.

10.3.3 Connector, user-configurable, not shielded

Type designation	Description	Part no.
KD 01-8-BA	M12 connector, axial, socket, 8-pin, A-coded, terminals	50112157

Table 10.7: Connectors for the LSIS 22x

## 11 Maintenance

### 11.1 General maintenance information

Usually, the code reader LSIS 22x does not require any maintenance by the operator.

#### **Cleaning**

Clean glass surface with a damp sponge soaked in commercial cleaning detergent. Then rub it with a soft, clean, dry cloth.



#### **Notice!**

*Do not use aggressive cleaning agents such as thinner or acetone for cleaning the device. Use of improper cleaning agents can damage the housing window.*

### 11.2 Repairs, servicing

Repairs to the device must only be carried out by the manufacturer.

 *Contact your Leuze distributor or service organization should repairs be required. The addresses can be found on the inside of the cover and on the back.*



#### **Notice!**

*When sending devices to Leuze electronic for repair, please provide an accurate description of the error.*

### 11.3 Disassembling, packing, disposing

#### **Repacking**

For later reuse, the device is to be packed so that it is protected.



#### **Notice!**

*Electrical scrap is a special waste product! Observe the locally applicable regulations regarding disposal of the product.*

## 12 Specifications

### 12.1 General specifications of the code readers

Type	LSIS 222 M5M-R1	LSIS 223 M5M-R1
<b>Electrical data</b>		
Operating voltage <sup>1)</sup>	10 ... 30VDC (PELV, Class II)	4.75 ... 5.25VDC (PELV, Class II)
Current consumption (recommended power supply unit)	< 300mA (3W)	< 500mA (2.5W)
Process interface	RS 232	USB
Transmission rate	300 ... 115,200 bit/s	USB 2.0
Switching input	SWI (pin 2): 10VDC	SWI (pin 2): 5VDC
Switching output	SWO (pin 4): 10 ... 30VDC max. = 20mA (short-circuit proof)	SWO (pin 4): 5VDC max. = 20mA (short-circuit proof)
<b>Optical data</b>		
Image sensor	global shutter CMOS	
Number of pixels	844 x 640	
Integrated LED illumination	red (approx. 624nm)	
Integrated target LED (aimer)	green (approx. 528nm)	
Code types	all common 1D- and 2D-codes	
Resolution	1D-codes: m = 0.127mm (5mil) 2D-codes: m = 0.169mm (6.67 mil)	
Object distance	1D-codes: 50 ... 400mm (code-dependent, see reading distances) 2D-code: 50 ... 200mm (code-dependent, see reading distances)	
<b>Operating and display elements</b>		
PWR LED green	operational readiness	
Two-color I/O LED	green 80ms: reading successful red: reading gate active	
Button	manual trigger	
<b>Mechanical data</b>		
Housing	diecast zinc	
Lens cover	Glass	
Protection class	IP 65 (with M12-connector screwed on)	
VDE safety class	III	
Weight	130g	
Dimensions (HxWxD)	32 x 40 x 65.5mm	
<b>Environmental data</b>		
Operating temperature range	0°C ... +40°C	
Storage temperature range	-20°C ... +70°C	
Air humidity	max. 90% rel. humidity, non-condensing	
LED illumination	free group (no photobiological danger) acc. to EN 62471:2008	
Vibration	IEC 60068-2-6, test FC	
Shock	IEC 60068-2-27, test Ea	
Electromagnetic compatibility	EN 61000-6-2, EN 61000-6-3	
Conformity	CE, FCC Class B, UL	

Table 12.1: Specifications of the LSIS 22x M5M-R1 code reader

- 1) Protective Extra Low Voltage (PELV) - protective extra-low voltage with reliable disconnection.  
For UL Applications: for use in class 2 circuits according to NEC only!

## 12.2 Dimensioned drawing

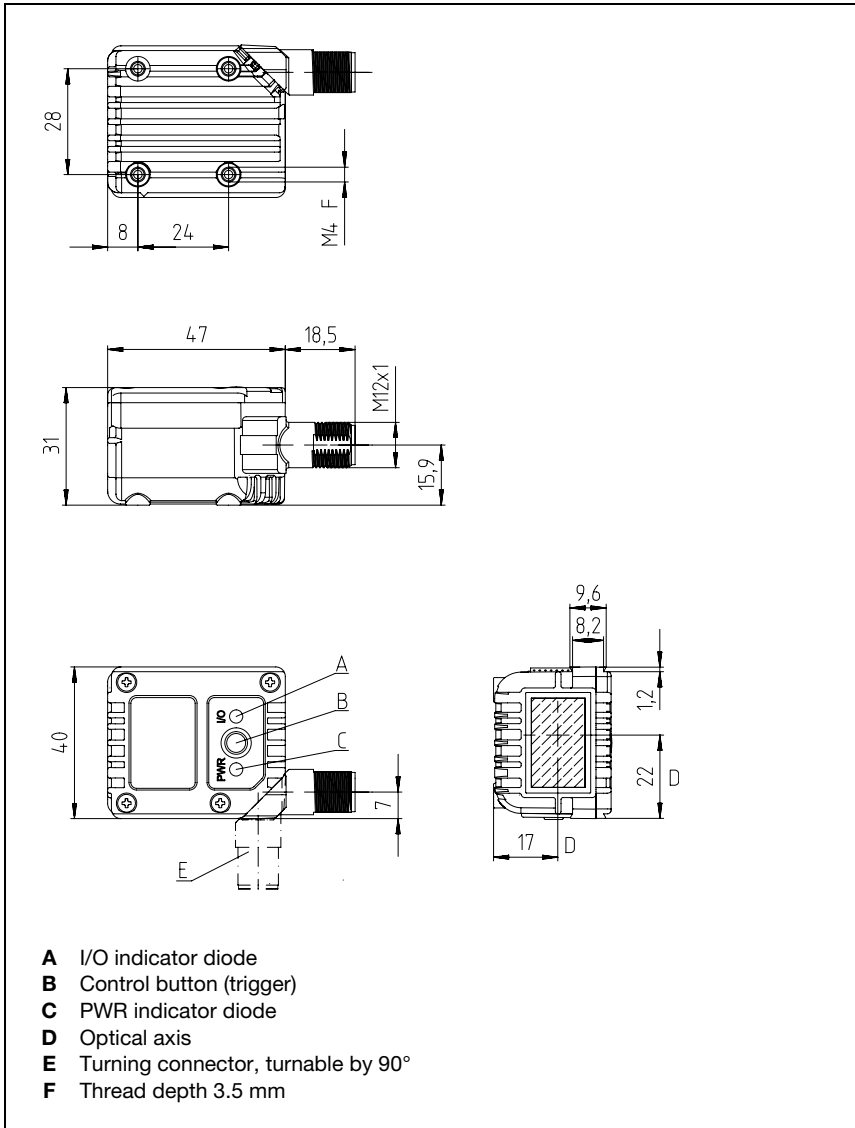

Figure 12.1: Dimensioned drawing code reader LSIS 22x

**13 Appendix**

**13.1 Declaration of conformity**

 the sensor people		
EG-KONFORMITÄTS- ERKLÄRUNG	EC DECLARATION OF CONFORMITY	DECLARATION CE DE CONFORMITE
Der Hersteller	The Manufacturer	Le constructeur
	<b>Leuze electronic GmbH + Co. KG</b> In der Bralke 1, PO Box 1111 73277 Owen, Germany	
erklärt, dass die nachfolgend aufgeführten Produkte den einschlägigen Anforderungen der genannten EG-Richtlinien entsprechen.	declares that the following listed products fulfil the relevant provisions of the mentioned EC Directives.	déclare que les produits identifiés suivants sont conformes aux directives CE mentionnées.
Produktbeschreibung:	Description of product:	Description de produit:
<b>2D-Code-Scanner LSIS 2xx</b>	<b>2D-codescanner LSIS 2xx</b>	<b>Scanner de codes 2D LSIS 2xx</b>
Angewandte EG-Richtlinie(n):	Applied EC Directive(s):	Directive(s) CE appliquées:
<b>2004/108/EG 2006/95/EG</b>	<b>2004/108/EC 2006/95/EC</b>	<b>2004/108/CE 2006/95/CE</b>
Angewandte Normen:	Applied standards:	Normes appliquées:
<b>EN 61000-6-2: 2005 EN 62471: 2008</b>		<b>EN 61000-6-3: 2007</b>
<div style="display: flex; justify-content: space-between; align-items: center;"> <div style="text-align: center;"> <p>14.5.2017</p> <p>Datum / Date / Date</p> </div> <div style="text-align: center;">  <p>Dr. Harald Grubel, Geschäftsführer / Director / Directeur</p> </div> </div>		
<div style="display: flex; justify-content: space-between; font-size: small;"> <div style="width: 30%;"> <p>Leuze electronic GmbH + Co. KG In der Bralke 1 D-73277 Owen Telefon +49 (0) 7021 973-0 Telefax +49 (0) 7021 973-199 info@leuze.de www.leuze.com LED-203M-148-02-FO</p> </div> <div style="width: 30%;"> <p>Leuze electronic GmbH + Co. KG, Sitz Owen, Registergericht Stuttgart, HRA 230712 Persönlich haftende Gesellschafterin Leuze electronic Geschäftsführungs-GmbH, Sitz Owen, Registergericht Stuttgart, HRB 230550 Geschäftsführer: Dr. Harald Grubel (Vorsitzender), Dr. Matthias Kirchner USt-IdNr. DE 145125211   Zolnummer 2554232 Es gelten ausschließlich unsere aktuellen Verkaufs- und Lieferbedingungen Only our current Terms and Conditions of Sale and Delivery shall apply</p> </div> <div style="width: 30%;"></div> </div>		

## 13.2 ASCII character set

ASCII	Dec.	Hex.	Oct.	Designation	Meaning
NUL	0	00	0	NULL	Zero
SOH	1	01	1	START OF HEADING	Start of heading
STX	2	02	2	START OF TEXT	Start of text characters
ETX	3	03	3	END OF TEXT	Last character of text
EOT	4	04	4	END OF TRANSMISS.	End of transmission
ENQ	5	05	5	ENQUIRY	Request for data trans.
ACK	6	06	6	ACKNOWLEDGE	Positive acknowledgment
BEL	7	07	7	BELL	Bell signal
BS	8	08	10	BACKSPACE	Backspace
HT	9	09	11	HORIZ. TABULATOR	Horizontal tabulator
LF	10	0A	12	LINE FEED	Line feed
VT	11	0B	13	VERT. TABULATOR	Vertical tabulator
FF	12	0C	14	FORM FEED	Form feed
CR	13	0D	15	CARRIAGE RETURN	Carriage return
SO	14	0E	16	SHIFT OUT	Shift out
SI	15	0F	17	SHIFT IN	Shift in
DLE	16	10	20	DATA LINK ESCAPE	Data link escape
DC1	17	11	21	DEVICE CONTROL 1	Device control character 1
DC2	18	12	22	DEVICE CONTROL 2	Device control character 2
DC3	19	13	23	DEVICE CONTROL 3	Device control character 3
DC4	20	14	24	DEVICE CONTROL 4	Device control character 4
NAK	21	15	25	NEG. ACKNOWLEDGE	Negative acknowledge
SYN	22	16	26	SYNCHRONOUS IDLE	Synchronization
ETB	23	17	27	EOF TRANSM. BLOCK	End of data transmission block
CAN	24	18	30	CANCEL	Invalid
EM	25	19	31	END OF MEDIUM	End of medium
SUB	26	1A	32	SUBSTITUTE	Substitution
ESC	27	1B	33	ESCAPE	Escape
FS	28	1C	34	FILE SEPARATOR	File separator
GS	29	1D	35	GROUP SEPARATOR	Group separator
RS	30	1E	36	RECORD SEPARATOR	Record separator
US	31	1F	37	UNIT SEPARATOR	Unit separator
SP	32	20	40	SPACE	Space
!	33	21	41	EXCLAMATION POINT	Exclamation point

<b>ASCII</b>	<b>Dec.</b>	<b>Hex.</b>	<b>Oct.</b>	<b>Designation</b>	<b>Meaning</b>
"	34	22	42	QUOTATION MARK	Quotation mark
#	35	23	43	NUMBER SIGN	Number sign
\$	36	24	44	DOLLAR SIGN	Dollar sign
%	37	25	45	PERCENT SIGN	Percent sign
&	38	26	46	AMPERSAND	Ampersand
'	39	27	47	APOSTROPHE	Apostrophe
(	40	28	50	OPEN. PARENTHESIS	Open parenthesis
)	41	29	51	CLOS. PARENTHESIS	Closed parenthesis
*	42	2A	52	ASTERISK	Asterisk
+	43	2B	53	PLUS	Plus sign
,	44	2C	54	COMMA	Comma
-	45	2D	55	HYPHEN (MINUS)	Hyphen
.	46	2E	56	PERIOD (DECIMAL)	Period (decimal)
/	47	2F	57	SLANT	Slant
0	48	30	60	0	Number
1	49	31	61	1	Number
2	50	32	62	2	Number
3	51	33	63	3	Number
4	52	34	64	4	Number
5	53	35	65	5	Number
6	54	36	66	6	Number
7	55	37	67	7	Number
8	56	38	70	8	Number
9	57	39	71	9	Number
:	58	3A	72	COLON	Colon
;	59	3B	73	SEMICOLON	Semicolon
<	60	3C	74	LESS THAN	Less than
=	61	3D	75	EQUALS	Equals
>	62	3E	76	GREATER THAN	Greater than
?	63	3F	77	QUESTION MARK	Question mark
@	64	40	100	COMMERCIAL AT	Commercial AT
A	65	41	101	A	Capital letter
B	66	42	102	B	Capital letter
C	67	43	103	C	Capital letter
D	68	44	104	D	Capital letter

ASCII	Dec.	Hex.	Oct.	Designation	Meaning
E	69	45	105	E	Capital letter
F	70	46	106	F	Capital letter
G	71	47	107	G	Capital letter
H	72	48	110	H	Capital letter
I	73	49	111	I	Capital letter
J	74	4A	112	J	Capital letter
K	75	4B	113	K	Capital letter
L	76	4C	114	L	Capital letter
M	77	4D	115	M	Capital letter
N	78	4E	116	N	Capital letter
O	79	4F	117	O	Capital letter
P	80	50	120	P	Capital letter
Q	81	51	121	Q	Capital letter
R	82	52	122	R	Capital letter
S	83	53	123	S	Capital letter
T	84	54	124	T	Capital letter
U	85	55	125	U	Capital letter
V	86	56	126	V	Capital letter
W	87	57	127	W	Capital letter
X	88	58	130	X	Capital letter
Y	89	59	131	Y	Capital letter
Z	90	5A	132	Z	Capital letter
[	91	5B	133	OPENING BRACKET	Opening bracket
\	92	5C	134	REVERSE SLANT	Reverse slant
]	93	5D	135	CLOSING BRACKET	Closing bracket
^	94	5E	136	CIRCUMFLEX	Circumflex
_	95	5F	137	UNDERSCORE	Underscore
‘	96	60	140	GRAVE ACCENT	Grave accent
a	97	61	141	a	Lower case letter
b	98	62	142	b	Lower case letter
c	99	63	143	c	Lower case letter
d	100	64	144	d	Lower case letter
e	101	65	145	e	Lower case letter
f	102	66	146	f	Lower case letter
g	103	67	147	g	Lower case letter



<b>ASCII</b>	<b>Dec.</b>	<b>Hex.</b>	<b>Oct.</b>	<b>Designation</b>	<b>Meaning</b>
h	104	68	150	h	Lower case letter
i	105	69	151	i	Lower case letter
j	106	6A	152	j	Lower case letter
k	107	6B	153	k	Lower case letter
l	108	6C	154	l	Lower case letter
m	109	6D	155	m	Lower case letter
n	110	6E	156	n	Lower case letter
o	111	6F	157	o	Lower case letter
p	112	70	160	p	Lower case letter
q	113	71	161	q	Lower case letter
r	114	72	162	r	Lower case letter
s	115	73	163	s	Lower case letter
t	116	74	164	t	Lower case letter
u	117	75	165	u	Lower case letter
v	118	76	166	v	Lower case letter
w	119	77	167	w	Lower case letter
x	120	78	170	x	Lower case letter
y	121	79	171	y	Lower case letter
z	122	7A	172	z	Lower case letter
{	123	7B	173	OPENING BRACE	Opening brace
	124	7C	174	VERTICAL LINE	Vertical line
}	125	7D	175	CLOSING BRACE	Closing brace
~	126	7E	176	TILDE	Tilde
DEL	127	7F	177	DELETE (RUBOUT)	Delete

### 13.3 Sample codes

#### 13.3.1 Bar codes module 0.3

Code type 01: Interleaved 2 of 5

Modul 0,3

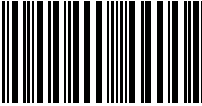

Code type 02: Code 39

Modul 0,3



Code type 11: Codabar

Modul 0,3



Code 128

Modul 0,3



Code type 08: GS1-128

Modul 0,3



Code type 06: UPC-A

SC 2



Code type 07: EAN 8

SC 3



Code type 10: EAN 13 Add-on

SC 0

S

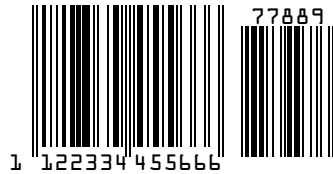

Figure 13.1: Bar code sample (module 0.3)

13.3.2 Bar codes module 0.5

Code type 01: Interleaved 2 of 5

Modul 0,5



Code type 02: Code 39

Modul 0,5



Code type 11: Codabar

Modul 0,5



Code 128

Modul 0,5



Code type 08: GS1-128

Modul 0,5



Code type 06: UPC-A

SC 4



Code type 07: EAN 8

SC 6



Code type 10: EAN 13 Add-on

SC 2



Figure 13.2: Bar code sample (module 0.5)

## 13.3.3 Other sample codes

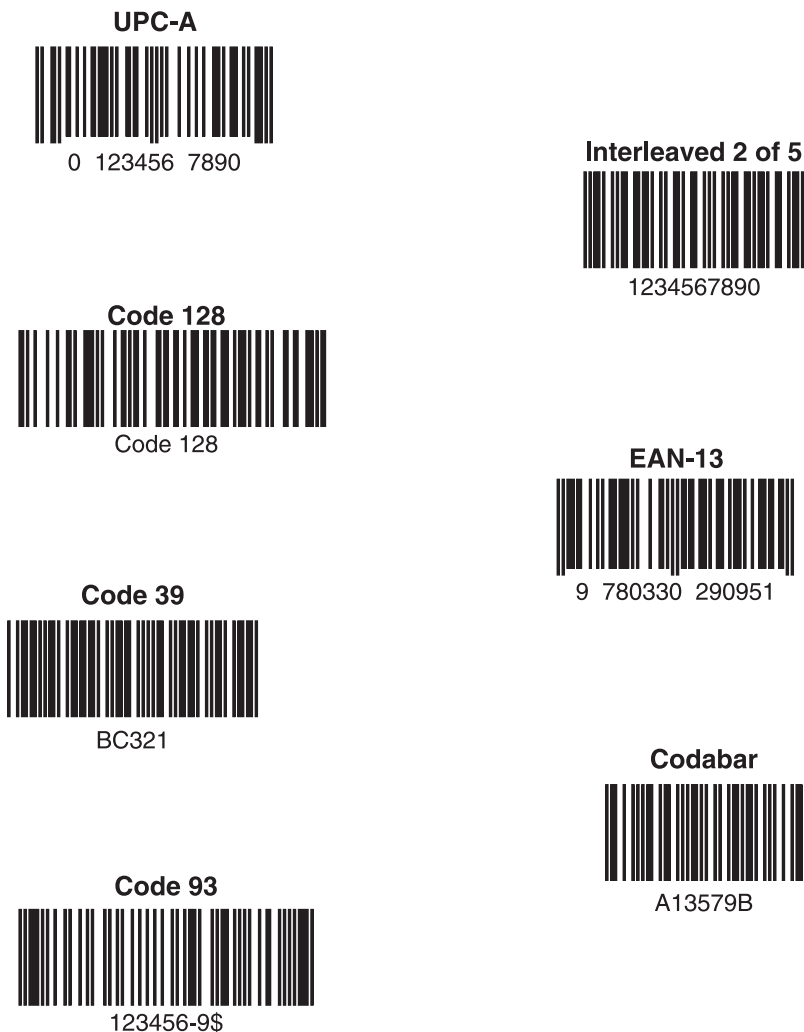

Figure 13.3: Sample codes



Figure 13.4: Sample codes

## 13.4 Programming codes for the configuration



Figure 13.5: Programming codes for configuration

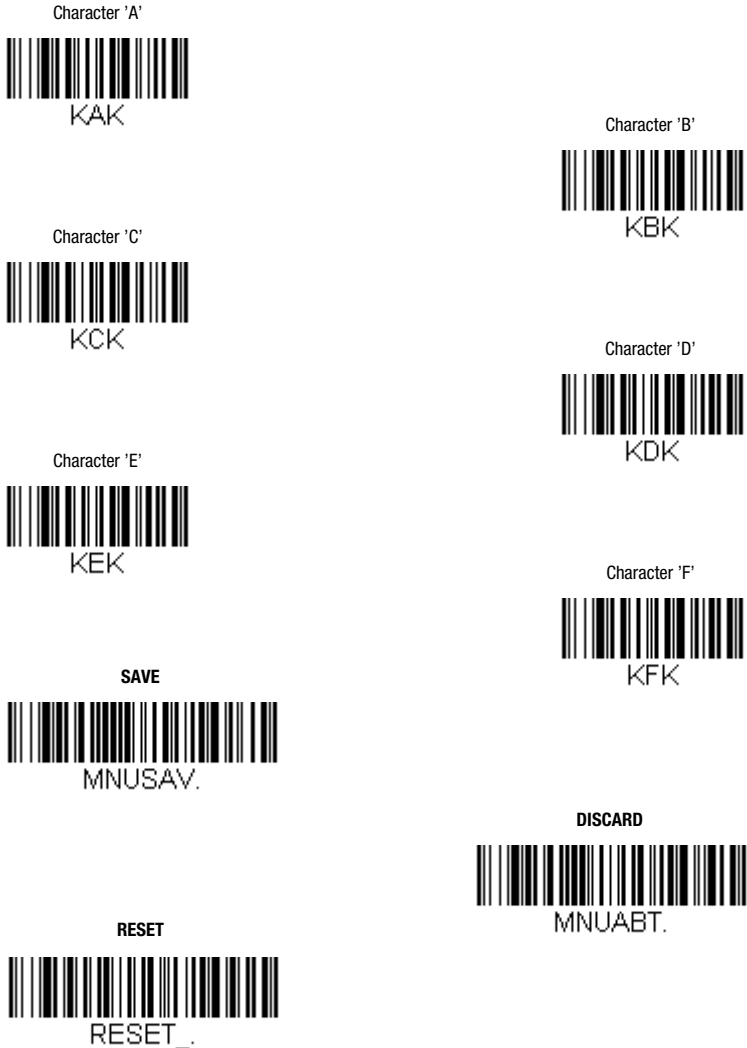

Figure 13.6: Programming codes for configuration



**Notice!**

*If you made an error while entering values, simply read in the **DISCARD** code and then again read in the code for the value.*

*Conclude parameter entry by reading in the **SAVE** code.*