

MA 208*i*

Modular interfacing unit for Leuze Ident and
RS 232 devices on Ethernet TCP/IP



Sales and Service

Germany

Sales Region North

Phone 07021/573-306
Tel. Int. + 34 93 4097900
Fax Int. + 34 93 94935820

Postal code areas

20000-38999
40000-65999
97000-97999

Sales Region South

Phone 07021/573-307
Tel. Int. + 34 93 94935820

Postal code areas

66000-96999

Sales Region East

Phone 035027/629-106
Fax 035027/629-107

Postal code areas

01000-19999
39000-39999
98000-99999

Worldwide

AR (Argentina)

Condelectric S.A.
Tel. Int. + 54 1148 361053
Fax Int. + 54 1148 361053

AT (Austria)

Schmachtl GmbH
Tel. Int. + 43 732 7646-0
Fax Int. + 43 732 7646-785

AU + NZ (Australia + New Zealand)

Balluff/Leuze Pty. Ltd.
Tel. Int. + 61 3 9720 4100
Fax Int. + 61 3 9738 2677

BE (Belgium)

Leuze electronic nv/sa
Tel. Int. + 32 2253 16-00
Fax Int. + 32 2253 15-36

BG (Bulgaria)

ATICS
Tel. Int. + 359 2 847 6244
Fax Int. + 359 2 847 6244

BR (Brazil)

Leuze electronic Ltda.
Tel. Int. + 55 11 5180-6130
Fax Int. + 55 11 5180-6141

CH (Switzerland)

Leuze electronic AG
Tel. Int. + 41 41 784 5656
Fax Int. + 41 41 784 5657

CL (Chile)

Imp. Tec. Vignola S.A.I.C.
Tel. Int. + 56 3235 11-11
Fax Int. + 56 3235 11-28

CN (China)

Leuze electronic Trading
(Shenzhen) Co. Ltd.
Tel. Int. + 86 755 862 64909
Fax Int. + 86 755 862 64901

CO (Colombia)

Componentes Electronicas Ltda.
Tel. Int. + 57 4 3511049
Fax Int. + 57 4 3511019

CZ (Czech Republic)

Schmachtl CZ s.r.o.
Tel. Int. + 420 244 0015-00
Fax Int. + 420 244 9107-00

DK (Denmark)

Leuze electronic Scandinavia ApS
Tel. Int. + 45 48 173200

ES (Spain)

Leuze electronic S.A.
Tel. Int. + 34 93 4097900
Fax Int. + 34 93 94935820

FI (Finland)

SKS-automatio Oy
Tel. Int. + 358 20 764-61
Fax Int. + 358 20 764-6820

FR (France)

Leuze electronic Sarl.
Tel. Int. + 33 160 0512-20
Fax Int. + 33 160 0503-65

GB (United Kingdom)

Leuze electronic Ltd.
Tel. Int. + 44 14 8040 85-00
Fax Int. + 44 14 8040 38-08

GR (Greece)

UTECO A.B.E.E.
Tel. Int. + 30 211 1206 900
Fax Int. + 30 211 1206 999

HK (Hong Kong)

Sensortech Company
Tel. Int. + 852 26510188
Fax Int. + 852 26510388

HR (Croatia)

Tipteh Zagreb d.o.o.
Tel. Int. + 385 1 381 6574
Fax Int. + 385 1 381 6577

HU (Hungary)

Kvaix Automatika Kft.
Tel. Int. + 36 1 272 2242
Fax Int. + 36 1 272 2244

ID (Indonesia)

P.T. Yabestindo Mitra Utama
Tel. Int. + 62 21 92861859
Fax Int. + 62 21 6451044

IL (Israel)

Galoz electronics Ltd.
Tel. Int. + 972 3 9023456
Fax Int. + 972 3 9021990

IN (India)

M + V Marketing Sales Pvt Ltd.
Tel. Int. + 91 124 4121623
Fax Int. + 91 124 434223

IT (Italy)

Leuze electronic s.r.l.
Tel. Int. + 39 02 26 1106-43
Fax Int. + 39 02 26 1106-40

JP (Japan)

C. Illies & Co., Ltd.
Tel. Int. + 81 3 3443 4143
Fax Int. + 81 3 3443 4118

KE (Kenia)

Profa-Tech Ltd.
Tel. Int. + 254 20 828095/6
Fax Int. + 254 20 828129

KR (South Korea)

Leuze electronic Co., Ltd.
Tel. Int. + 82 31 3828228
Fax Int. + 82 31 3828522

MK (Macedonia)

Tipteh d.o.o. Skopje
Tel. Int. + 389 70 399 474
Fax Int. + 389 23 174 197

MX (Mexico)

Motivren S.A.
Tel. Int. + 52 81 8371 8616
Fax Int. + 52 81 8371 8588

MY (Malaysia)

Ingermarg (M) SDN.BHD
Tel. Int. + 60 360 3427-88
Fax Int. + 60 360 3421-88

NG (Nigeria)

SABROW HI-TECH E. & A. LTD.
Tel. Int. + 234 80333 86366
Fax Int. + 234 80333 84463518

NL (Netherlands)

Leuze electronic BV
Tel. Int. + 31 418 65 35-44
Fax Int. + 31 418 65 38-08

NO (Norway)

Elteco A/S
Tel. Int. + 47 35 56 20-70
Fax Int. + 47 35 56 20-99

PL (Poland)

Balluff Sp. z o. o.
Tel. Int. + 48 71 338 49 29
Fax Int. + 48 71 338 49 30

PT (Portugal)

LA2P, Lda.
Tel. Int. + 351 21 4 447070
Fax Int. + 351 21 4 447075

RO (Romania)

O BOYLE s.r.l.
Tel. Int. + 40 2 56201346
Fax Int. + 40 2 56221036

RS (Republic of Serbia)

Tipteh d.o.o. Beograd
Tel. Int. + 381 11 3131 057
Fax Int. + 381 11 3131 326

RU (Russian Federation)

ALL IMPEX 2001
Tel. Int. + 7 495 9213012
Fax Int. + 7 495 6462092

SE (Sweden)

Leuze electronic Scandinavia ApS
Tel. Int. + 46 380-490951

SG + PH (Singapore + Philippines)

Balluff Asia Pte Ltd
Tel. Int. + 65 6252 43-84
Fax Int. + 65 6252 90-60

SI (Slovenia)

Tipteh d.o.o.
Tel. Int. + 386 1200 51-50
Fax Int. + 386 1200 51-51

SK (Slovakia)

Schmachtl SK s.r.o.
Tel. Int. + 421 2 58275600
Fax Int. + 421 2 58275601

TH (Thailand)

Industrial Electrical Co. Ltd.
Tel. Int. + 66 2 642 6700
Fax Int. + 66 2 642 4250

TR (Turkey)

Leuze electronic San ve Tic.Ltd.Siti.
Tel. Int. + 90 216 456 6704
Fax Int. + 90 216 456 3650

TW (Taiwan)

Great Colvue Technology Co., Ltd.
Tel. Int. + 886 2 2983 80-77
Fax Int. + 886 2 2983 33-73

UA (Ukraine)

SV Altera OOO
Tel. Int. + 38 044 4961888
Fax Int. + 38 044 4961818

US + CA (United States + Canada)

Leuze electronic, Inc.
Tel. Int. + 1 248 486-4466
Fax Int. + 1 248 486-6699

ZA (South Africa)

Countapulse Controls (PTY).Ltd.
Tel. Int. + 27 116 1575-56
Fax Int. + 27 116 1575-13

1	General information	5
1.1	Explanation of symbols	5
1.2	Declaration of Conformity	5
1.3	Description of functions	6
1.4	Definition of terms	7
2	Safety notices	8
2.1	General safety notices	8
2.2	Safety standards	8
2.3	Intended use	8
2.4	Working safely	9
3	Fast commissioning / operating principle	10
3.1	Mounting	10
3.2	Device arrangement and selection of the mounting location	10
3.3	Electrical connection	10
3.3.1	Connecting the Leuze device	11
3.3.2	Connecting the power supply and the bus cable	11
3.4	Starting the device	11
3.5	MA 208 <i>i</i> on Ethernet	12
3.5.1	Manually setting the IP address	12
3.5.2	Ethernet host communication	13
3.5.3	TCP/IP	14
3.5.4	UDP	14
4	Device description	15
4.1	General Information to the connector units	15
4.2	Characteristics of the connector units	15
4.3	Device construction	16
4.4	Operating modes	17
4.5	Fieldbus systems	18
4.5.1	Ethernet	18
5	Specifications	20
5.1	General specifications	20
5.2	Dimensioned drawings	21
5.3	Type overview	22

6	Installation and mounting	23
6.1	Storage, transportation	23
6.2	Mounting	24
6.3	Device arrangement	25
6.3.1	Selecting a mounting location	25
6.4	Cleaning	25
7	Electrical connection	26
7.1	Safety notices for the electrical connection	26
7.2	Electrical connection	27
7.2.1	PWR IN – voltage supply / switching input/output	27
7.2.2	PWR OUT switching input/output	29
7.3	BUS IN	29
7.4	BUS OUT	30
7.5	Device interfaces	31
7.5.1	RS 232 device interface (accessible after opening the device, internal)	31
7.5.2	Service interface (internal)	32
7.6	Ethernet wiring	33
7.7	Cable lengths and shielding	33
8	Status displays and operational controls	34
8.1	LED status indicators	34
8.1.1	LED indicators on the circuit board	34
8.1.2	LED indicators on the housing	35
8.2	Internal interfaces and operational controls	36
8.2.1	Overview of operational controls of the	36
8.2.2	Connector X30 ... connectors	38
8.2.3	RS 232 service interface – X33	38
8.2.4	S10 service switch	38
8.2.5	Rotary switch S4 for device selection	39
9	Configuration	40
9.1	Connecting the service interface	40
9.2	Reading out information in Service mode	40
10	Telegram	44
10.1	Structure of the fieldbus telegram	44
10.2	Description of the input bytes (status bytes)	45

10.2.1	Structure and meaning of the input bytes (status bytes)	45
10.2.2	Detailed description of the bits (input byte 0)	46
10.2.3	Detailed description of the bits (input byte 1)	46
10.3	Description of the output bytes (control bytes)	47
10.3.1	Structure and meaning of the output bytes (control bytes)	47
10.3.2	Detailed description of the bits (output byte 0)	48
11	Modes	49
11.1	Functionality of the data exchange	49
11.1.1	Writing slave data in Collective mode (PLC -> gateway)	49
11.1.2	Command mode	50
12	Commissioning and configuration	52
12.1	Measures to be performed prior to the initial commissioning	52
12.2	Starting the device and setting the communication parameters	53
12.2.1	Manually setting the IP address	53
12.2.2	Ethernet host communication	54
12.2.3	TCP/IP	55
12.2.4	UDP	55
12.3	Setting the read parameters on the Leuze device	55
12.3.1	Specific feature for the use of hand-held scanners (bar code and 2D devices, combi devices with RFID)	57
12.3.2	Specific features in the operation of an RFM/RFI	58
13	Diagnostics and troubleshooting	59
13.1	General causes of errors	59
13.2	Interface errors	60
14	Type overview and accessories	61
14.1	Part number code	61
14.2	Type overview	61
14.3	Accessory connectors	61
14.4	Accessory ready-made cables for voltage supply	62
14.4.1	Contact assignment of PWR connection cable	62
14.4.2	Specifications of the cables for voltage supply	62
14.4.3	Order codes of the cables for voltage supply	63
14.5	Accessory ready-made cables for bus connection	63
14.5.1	General information	63
14.5.2	Contact assignments of M12 Ethernet connection cable KB ET...	63
14.5.3	Technical data of M12 Ethernet connection cable KB ET...	64

14.5.4	Order codes of M12 Ethernet connection cable KB ET.....	64
14.6	Accessory ready-made cables for connecting Leuze Ident devices	65
14.6.1	Order codes for the device connection cables	65
14.6.2	Contact assignment for the device connection cables	65
15	Maintenance	66
15.1	General maintenance information	66
15.2	Repairs, servicing	66
15.3	Disassembling, packing, disposing	66
16	Specifications for Leuze end devices	67
16.1	Standard setting, KONTURflex (S4 switch position 0)	67
16.2	Bar code reader BCL 8 (S4 switch position 1)	69
16.3	Bar code reader BCL 22 (S4 switch position 2)	70
16.4	Bar code reader BCL 32 (S4 switch position 3)	71
16.5	Bar code reader BCL 300i, BCL 500i (S4 switch position 4).	72
16.6	Bar code reader BCL 90 (S4 switch position 5)	73
16.7	LSIS 122 (S4 switch position 6)	74
16.8	LSIS 4x2i (S4 switch position 7)	75
16.9	Hand-held scanner (S4 switch position 8)	76
16.10	RFI, RFM, RFU RFID readers (S4 switch position 9)	77
16.11	BPS 8 bar code positioning system (S4 switch position A)	78
16.12	AMS distance measurement device, ODSL xx optical distance sensors with RS 232 interface (S4 switch position B)	79
16.13	Modular interfacing unit MA 3x (S4 switch position C)	81
16.14	Resetting the parameters (S4 switch position F)	82
17	Appendix	83
17.1	ASCII Table	83

1 General information

1.1 Explanation of symbols

The symbols used in this operating manual are explained below.



Attention!

This symbol precedes text messages which must strictly be observed. Failure to comply with this information results in injuries to persons or damage to the equipment.



Notice!

This symbol indicates text passages containing important information.

1.2 Declaration of Conformity

The MA 208*i* modular interfacing units have been designed and manufactured in accordance with applicable European directives and standards.



Notice!

The Declaration of Conformity for these devices can be requested from the manufacturer.

The manufacturer of the product, Leuze electronic GmbH + Co. KG in D-73277 Owen, possesses a certified quality assurance system in accordance with ISO 9001.



1.3 Description of functions

The MA 208*i* modular interfacing unit is used to connect Leuze devices directly to the fieldbus.

Bar code reader:	BCL 8, 22, 32, 300i, 500i, 90
2D code reader:	LSIS 122, LSIS 4x2i
Hand-held scanner	ITxxxx, HFU/HFM
RFID read-write devices:	RFM 12, 32, 62 & RFI 32, RFU 61, 81
Bar code positioning system:	BPS 8
Distance measurement device:	AMS 200
Optical distance sensors:	ODSL 9, ODSL 30, ODSL 96B
Measuring light curtain:	KONTURflex to Quattro-RSX/M12
multiNet master connection box:	MA 3x
Additional RS 232 devices:	scales, third-party devices

This is accomplished by transmitting the data from the DEV via an RS 232 (V.24) interface to the MA 208*i* where a module converts it into the Ethernet TCP/IP format. The data format on the RS 232 interface corresponds to the Leuze standard data format (9600bd, 8N1 and STX, data, CR, LF).

The corresponding Leuze devices are selected using a rotary code switch on the circuit board of the connector unit. Many additional RS 232 devices can be connected through a universal position.

1.4 Definition of terms

For better understanding of the explanations provided in this document, a definition of terms follows below:

- **Bit designation:**
The 1st bit or byte begins with count number "0" and means bit/byte 2^0 .
- **Data length:**
Size of a valid, continuous data packet in bytes.
- **Consistent:**
Data which belongs together with regard to content and which must not be separated is referred to as consistent data. When identifying objects, it must be ensured that the data is transmitted completely and in the correct order, otherwise the result is falsified.
- **Leuze device (DEV):**
Leuze devices, e.g., bar code readers, RFID readers, VisionReader...
- **Online command:**
These commands refer to the respective, connected ident device and may be different depending on the device. These commands are not interpreted by the MA 208*i*, but are instead transmitted transparently (see description of Ident device).
- **CR:**
Cross reference.
- **Perspective of I/O data in the description:**
Output data is data which is sent by the control to the MA. Input data is data which is sent by the MA to the control.
- **Toggle bits:**
 - Status toggle bit**
Each change of state indicates that an action was performed, e.g., bit ND (new data): each change of state indicates that new received data was transmitted to the PLC.
 - Control toggle bit**
An action is performed on each change of state, e.g., bit SDO: on each change of state, the registered data is sent by the PLC to the MA 208*i*.

2 Safety notices

2.1 General safety notices

Documentation

All entries in this technical description must strictly be observed, in particular those in the "Safety notices" section. Keep this technical description in a safe place. It should be available at all times.

Safety regulations

Observe the locally applicable legal regulations and the rules of the employer's liability insurance association.

Repair

Repairs must only be carried out by the manufacturer or an authorized representative.

2.2 Safety standards

The devices of the series MA 2xx*i* were developed, manufactured and tested in accordance with the applicable safety standards. They correspond to the state of the art.

2.3 Intended use



Attention!

The protection of personnel and the device is guaranteed only if the device is operated in a manner corresponding to its intended use.

Areas of application

The MA 208*i* modular interfacing unit is used for connecting Leuze devices such as barcode- or 2D code readers, hand-held scanners, RFID read-write devices, etc. directly to the fieldbus. A detailed list can be found in "Description of functions" on page 6.

2.4 Working safely

**Attention!**

Access to or changes on the device, except where expressly described in this operating manual, is not authorized.

Safety regulations

Observe the locally applicable legal regulations and the rules of the employer's liability insurance association.

Qualified personnel

Mounting, commissioning and maintenance of the device must only be carried out by qualified personnel.

Electrical work must be carried out by a certified electrician.

3 Fast commissioning / operating principle



Notice!

Below you will find a **short description for the initial commissioning** of the Ethernet gateway MA 208*i*. Detailed explanations for the listed points can be found throughout the handbook.

3.1 Mounting

The gateway mounting plate MA 208*i* can be mounted in two different ways:

- using four threaded holes (M6) or
- using two M8x6 screws on the two lateral grooves.

3.2 Device arrangement and selection of the mounting location

Ideally, the MA 208*i* should be mounted so that it is easily accessible near the Ident device in order to ensure good operability, e.g., for configuring the connected device.

Detailed information can be found in chapter 6.3.1.

3.3 Electrical connection

The devices from the MA 2xx*i* family feature four M12 connectors/sockets which are coded differently depending on the interface.

The voltage supply (**PWR IN**) as well as the switching inputs/outputs (**PWR OUT** or **PWR IN**) are connected there. The number and function of the switching inputs/outputs is dependent on the connected end device.

An internal RS 232 interface is used for connecting the respective Leuze device. Another internal RS 232 interface functions as a service interface for configuring the connected device via a serial null modem cable.

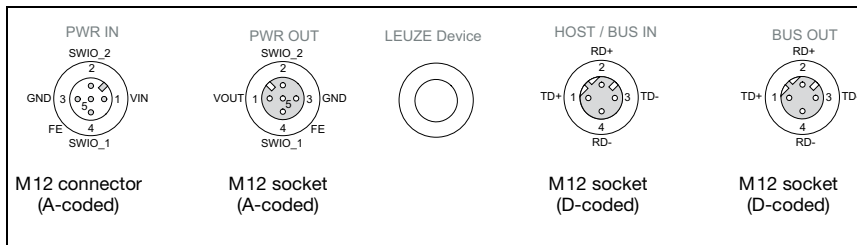

Figure 3.1: MA 208*i* connections

Detailed information can be found in chapter 7.

3.3.1 Connecting the Leuze device

- ↳ To connect the Leuze device to the internal RS 232 device interface, open the housing of the MA 208*i* and guide the corresponding device cable (see chapter 14.6, e.g., KB 031 for BCL 32) through the middle threaded opening.
- ↳ Connect the cable to the internal device interface (**X30**, **X31** or **X32**, see chapter 7.5.1).
- ↳ Use rotary switch **S4** (see chapter 8.2.5) to select the connected device.
- ↳ Now screw the PG cable gland into the threaded opening to provide strain relief and ensure protection class IP 65.
- ↳ Finally, close the housing of the MA 208*i*.



Attention!

Only then may the supply voltage be applied.

Upon startup of the MA 208*i*, the device selection switch is queried and the gateway automatically sets itself to the Leuze device.

Connecting functional earth FE

- ↳ Ensure that the functional earth (FE) is connected correctly.

Unimpaired operation is only guaranteed when the functional earth is connected properly. All electrical disturbances (EMC couplings) are discharged via the functional earth connection.

3.3.2 Connecting the power supply and the bus cable

- ↳ Ideally, use the ready-made cables listed in chapter 14.4.3 to connect the gateway to the power supply via the **PWR IN** connection.
- ↳ The ready-made cables listed in chapter 14.5.4 are preferred for connecting the gateway to the fieldbus via the **HOST / BUS IN** connection.
- ↳ If applicable, use the **BUS OUT** connection if you would like to construct a network with linear topology.

3.4 Starting the device

- ↳ Apply the supply voltage +18 ... 30VDC (typ. +24VDC); the MA 208*i* starts up. The PWR LED displays that it is ready for operation.

3.5 MA 208*i* on Ethernet

Setting the communication parameters

With the communication parameters, you determine how data is exchanged between MA 208*i* and host system, monitor PCs etc.

The communication parameters are **independent** of the topology in which the MA 208*i* is operated (see "Ethernet" on page 18).

On delivery from firmware 1.1.0.0, automatic address assignment is deactivated via DHCP and a permanent IP address is set:

Device address: 192.168.61.100.

Net mask: 255.255.255.0

The setting can be adapted via Leuze configuration software BCL-Config, BPS-Config or RF-Config. In these tools, the MA 208*i* has been created as a device to enable setting of parameters in the usual way via the service interface.

3.5.1 Manually setting the IP address

If the IP address of the devices should be permanently set on your system, proceed as follows:

- ↳ *Have the network administrator specify the data for IP address, net mask and gateway address of the MA 208*i*.*
- ↳ *Select the connected device via the device selection switch.*
- ↳ *Apply the supply voltage +18 ... 30VDC (typ. +24VDC); the MA 208*i* starts up.*
- ↳ *Now switch the service switch to "MA".*



Notice!

*The service switch must be in switch position "MA" here so that the MA 208*i* can be addressed via the service interface.*

- ↳ *Connect the serial RS 232 Sub-D interface of the MA 208*i* to the serial interface of your PC.*
- ↳ *Make the necessary settings in the configuration window.*

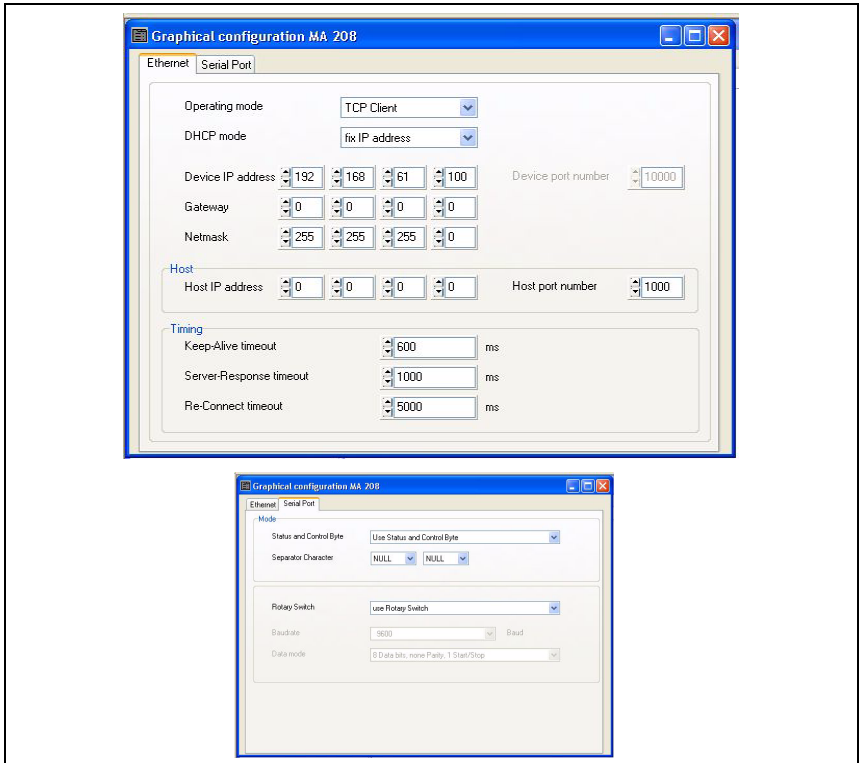

Figure 3.2: Setting the parameters manually

3.5.2 Ethernet host communication

The Ethernet host communication enables the configuration of connections to an external host system. Both UDP as well as TCP/IP (in either client or server mode) can be used. The connection-free UDP protocol is used primarily to transfer process data to the host (monitor operation). The connection-oriented TCP/IP protocol can also be used to transfer commands from the host to the device. With this connection, the data is backed up by the TCP/IP protocol itself.

If you would like to use the TCP/IP protocol, you must also define whether the MA 208*i* is to operate as a TCP client or as a TCP server.

↳ *Contact your network administrator to determine which communication protocol is used.*

3.5.3 TCP/IP

↳ Set the TCP/IP mode of the MA 208*i*.

In **TCP client mode**, the MA 208*i* actively establishes the connection to the primary host system (PC / PLC as server). The MA 208*i* requires from the user the IP address of the server (host system) and the port number on which the server (host system) accepts a connection. In this case, the MA 208*i* determines when and with whom a connection is established!

↳ With a MA 208*i* as TCP client, set the following values:

- IP address of the TCP server (normally the PLC/host computer)
- Port number of the TCP server
- Optional: Timeout for the wait time for an answer from the server
- Optional: Repetition time for renewed communication attempt following a timeout

In **TCP server mode**, the primary host system (PC / PLC) actively establishes the connection and the connected MA 208*i* waits for the connection to be set up. The TCP/IP stack requires information from the user regarding the local port of the MA 208*i* (port number) on which the connection requests of a client application (host system) are to be accepted. If there is a connection request and a connection is established by the primary host system (PC / PLC as client), the MA 208*i* (server mode) accepts the connection. Data can then be sent and received.

↳ With a MA 208*i* as TCP server, also set the following values:

- Port number for the communication of the MA 208*i* with the TCP client

The corresponding adjustment options can be found in the configuration tool.

3.5.4 UDP

The MA 208*i* requires from the user the IP address and the port number of the communication partner. Correspondingly, the host system (PC / PLC) now also requires the set IP address of the MA 208*i* and the selected port number. By assigning these parameters, a socket is formed via which the data can be sent and received.

↳ Set the following values:

- IP address of the communication partner
- Port number of the communication partner

The corresponding adjustment options can be found in the configuration tool.

4 Device description

4.1 General Information to the connector units

The modular interfacing unit of the MA 2xx*i* family is a versatile gateway for integrating Leuze RS 232 devices (e.g., BCL 22 bar code readers, RFID devices, RFM 32, AMS 200) in the respective fieldbus. The MA 2xx*i* gateways are intended for use in industrial environments with a high protection class. Various device versions are available for the conventional fieldbuses. With a stored parameter structure for the connectable RS 232 devices, commissioning could hardly be simpler.

4.2 Characteristics of the connector units

A special characteristic of the MA 208*i* device family are three function modes:

1. Transparent mode
In this function mode, the MA 208*i* functions as a pure gateway with automatic communication from and to the PLC. Absolutely no special programming by the user is necessary for this purpose. The data is not buffered or stored temporarily, however. Instead, it is "passed on".
The programmer must make certain to retrieve the data from the input memory of the PLC at the right time, as it is otherwise overwritten by new data.
2. Collective mode
In this operating mode, data and telegram parts are temporarily stored in the memory (buffer) of the MA and sent to the RS 232 interface or to the PLC in a telegram by means of bit activation. In this mode, however, all communication control must be programmed on the PLC.
This function mode is helpful, for example, for very long telegrams or when one or more codes with long code lengths are read.



Notice!

*The Collective mode is **not available for the MA 208i**. Due to a variable telegram length, data can always be transmitted in its entirety independent of its length. It is not necessary to transfer data in blocks.*

3. Command mode
With this special operating mode, it is possible to use the first bytes of the data range to transmit predefined commands to the connected device by means of bit activation. For this purpose, device-dependent commands (so-called online commands) are predefined via the device selection switch, see chapter 16 "Specifications for Leuze end devices".

4.3 Device construction

The MA 208*i* modular interfacing unit is used for interconnecting Leuze devices, such as the BCL 8, BCL 22, etc., directly to the fieldbus. This is accomplished by transmitting the data from the Leuze device via an RS 232 (V.24) interface to the MA 208*i* where a module converts it into the fieldbus format. The data format of the RS 232 interface corresponds to the standard Leuze data format.

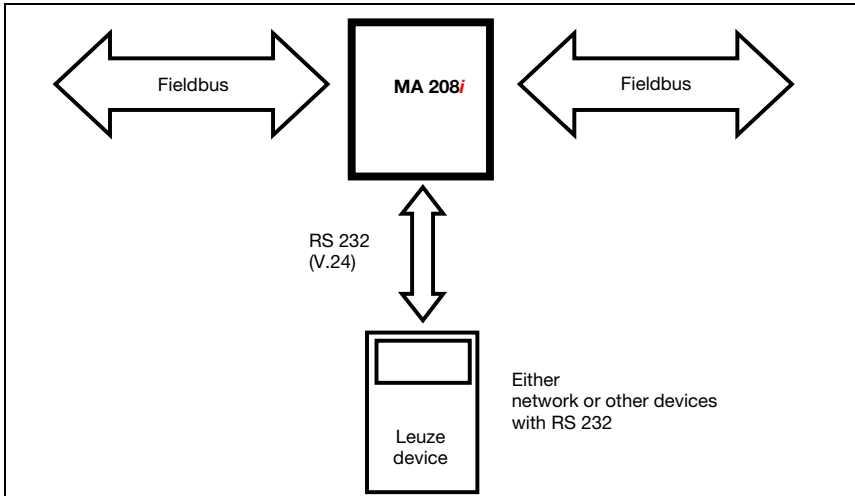

Figure 4.1: Connection of a Leuze device (BCL, RFI, RFM, VR) to the fieldbus

The cable of the respective Leuze device is guided through cable bushings with PG cable glands into the MA 208*i* and connected there with the PCB connectors.

The MA 208*i* is intended as a gateway for any RS 232 devices, e.g., BCL 90 with MA 90, hand-held scanners, scales or for coupling a multiNet network.

The RS 232 cables are internally connectable using JST plug connectors. The cable can be connected to the device using a stable PG cable gland which provide strain relief and protection against contamination.

With the help of adapter cables with Sub-D 9 or open cable end, other RS 232 devices can also be connected.

4.4 Operating modes

For fast commissioning, the MA 208*i* offers an additional operating mode, the "Service mode", in addition to the "Standard mode". To do this, you need a PC/laptop with a suitable terminal program, as BCL-Config from Leuze or similar.

Service switch

Select between "operation" and "service" modes with the service switch. You have the following options:

Pos. RUN:

Operation

The Leuze device is connected to the fieldbus and communicates with the PLC.

Pos. DEV:

Service Leuze device

The connection between the Leuze device and the fieldbus is interrupted. With this switch position, you can communicate directly with the Leuze device at the fieldbus gateway via RS 232. You can send online commands via the service interface, configure the Leuze device using the corresponding BCL- BPS-, ...-Config configuration software and have the read data of the Leuze device output.

Pos. MA:

Service fieldbus gateway

With this switch setting, your PC/terminal is connected with the fieldbus gateway. In doing so, the current setting values of the MA (e.g. address, RS 232 parameters) can be called up via a 'v' command.

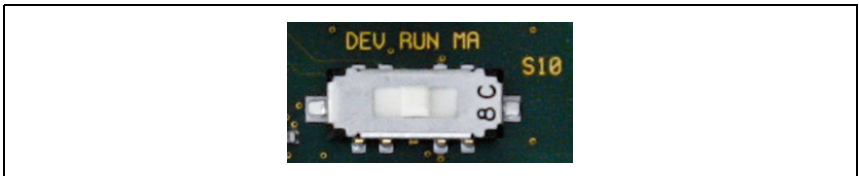

Figure 4.2: Service-switch switch positions



Notice!

If the service switch is on one of the service settings, the PWR LED flashes on the front side of the device, see chapter 8.1.2 "LED indicators on the housing".

Furthermore, on the control, the SMA service bit of the status bytes signals that the MA is in service mode.

Service interface

The service interface can be accessed once the MA 208*i* housing cover has been removed and features a 9-pin Sub-D connector (male). A crossed RS 232 connection cable is required to make the Rx*D*, Tx*D* and GND connections.

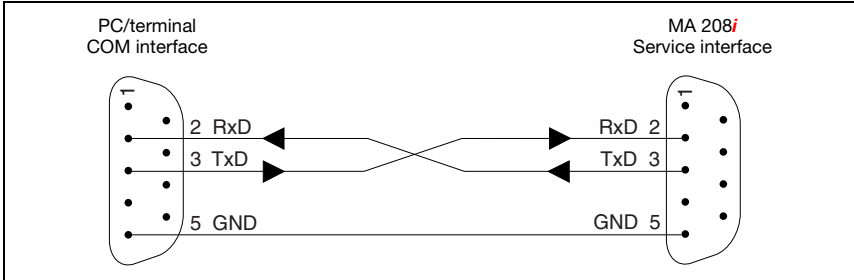

Figure 4.3: Connecting the service interface to a PC/terminal



Attention!

For the service PC to function, the RS 232 parameters must be the same as those of the MA. The Leuze standard setting of the interface is 9600bd, 8N1 and STX, data, CR, LF.

4.5 Fieldbus systems

Various product variants of the MA 2xx*i* series are available for connecting to different fieldbus systems such as PROFIBUS DP, PROFINET-IO, DeviceNet and Ethernet.

4.5.1 Ethernet

The MA 208*i* is designed as an Ethernet device (acc. to IEEE 802.3) with a standard baud rate of 10/100 Mbit. A fixed MAC ID is assigned to each MA 208*i* by the manufacturer; this ID cannot be changed.

The MA 208*i* automatically supports the transmission rates of 10 Mbit/s (10Base T) and 100 Mbit/s (10Base TX), as well as auto-negotiation and auto-crossover.

The MA 208*i* features multiple M 12 connectors / sockets for the electrical connection of the supply voltage, the interface and the switching inputs and outputs. Additional information on the electrical connection can be found in chapter 7.

The MA 208*i* supports the following protocols and services:

- TCP / IP (client / server)
- UDP
- DHCP
- ARP
- PING

For communication with the superior host system, the corresponding TCP/IP protocol (client/server mode) or UDP must be selected. Further information on commissioning can be found in chapter 12.

Ethernet – star topology

The MA 208*i* can be operated as a single device (standalone) in an Ethernet star topology with individual IP address.

The IP address is either set permanently via the RS 232 interface or assigned dynamically via a DHCP server.

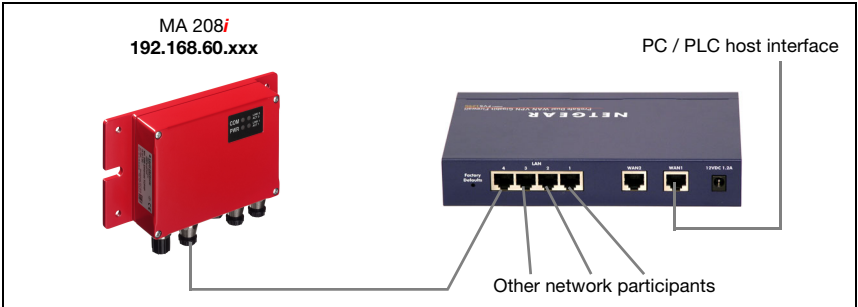

Figure 4.4: Ethernet with star topology

Ethernet – linear topology

The innovative further development of the MA 208*i* with integrated switch functionality offers the option of connecting multiple gateways of type MA 208*i* to one another without direct connection to a switch. In addition to the classic "star topology", a "linear topology" is thus also possible.

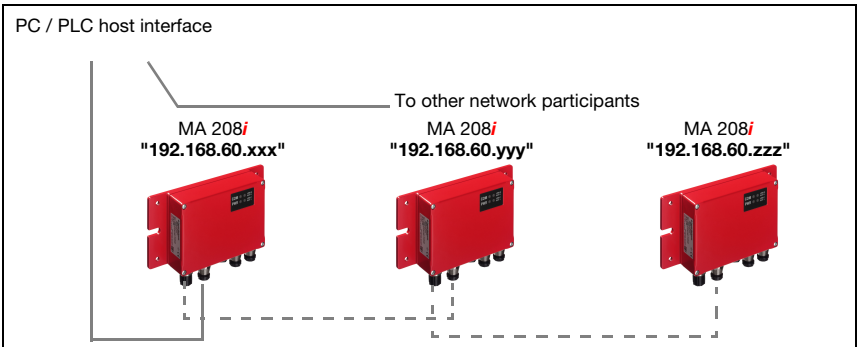

Figure 4.5: Ethernet with linear topology

Each participant in this network requires its own unique IP address, which must be assigned to it via the RS 232 interface. Alternatively, the DHCP procedure can be used.

The maximum length of a segment (connection from the hub to the last participant) is limited to 100m.

5 Specifications

5.1 General specifications

Electrical data

Interface type 1	Ethernet TCP/IP, integrated switch, BUS: 2x M12 socket (D-coded) PWR/IO: 1x M12 connector (A-coded), 1x M12 socket (A-coded)
Protocols	Ethernet TCP/IP communication (client/server) UDP DHCP ARP PING
Baud rate	10/100MBd
Interface type 2	RS 232
Baud rate	300bit/s ... 115200bit/s, default: 9600
Service interface	RS 232, 9-pin Sub-D connector, Leuze standard data bit: 8, parity: None, stop bit: 1
Data format	
Switching input/output	1 switching input/1 switching output device-dependent voltage
Operating voltage	18 ... 30VDC
Power consumption	max. 5VA (without DEV, current consumption max. 300mA)
Max stress on the connector (PWR IN/OUT)	3A

Indicators

LED LINK0	green connection possible yellow RX/TX0 data transmission
LED LINK1	green connection possible yellow RX/TX1 data transmission
COM LED	green bus state ok red bus error
PWR LED	green power red collection error

Mechanical data

Protection class	IP 65 (with screwed-on M12 and connected Leuze device)
Weight	700 g
Dimensions (HxWxD)	130 x 90 x 41 mm / with plate: 180 x 108 x 41 mm
Housing	diecast aluminum
Connection	2 x M12: BUS IN / BUS OUT Ethernet TCP/IP 1 connector: RS 232 1 x M12: Power IN/GND and switching input/output 1 x M12: Power OUT/GND and switching input/output

Environmental data

Operating temperature range	0°C ... +55°C
Storage temperature range	-20°C ... +60°C
Air humidity	max. 90% rel. humidity, non-condensing
Vibration	IEC 60068-2-6, test FC
Shock	IEC 60068-2-27, test Ea
Electromagnetic compatibility	EN 61000-6-3:2007 (interference emissions for residential, commercial and light-industrial environments) EN 61000-6-2:2005 (interference rejection for industrial sectors)

5.2 Dimensioned drawings

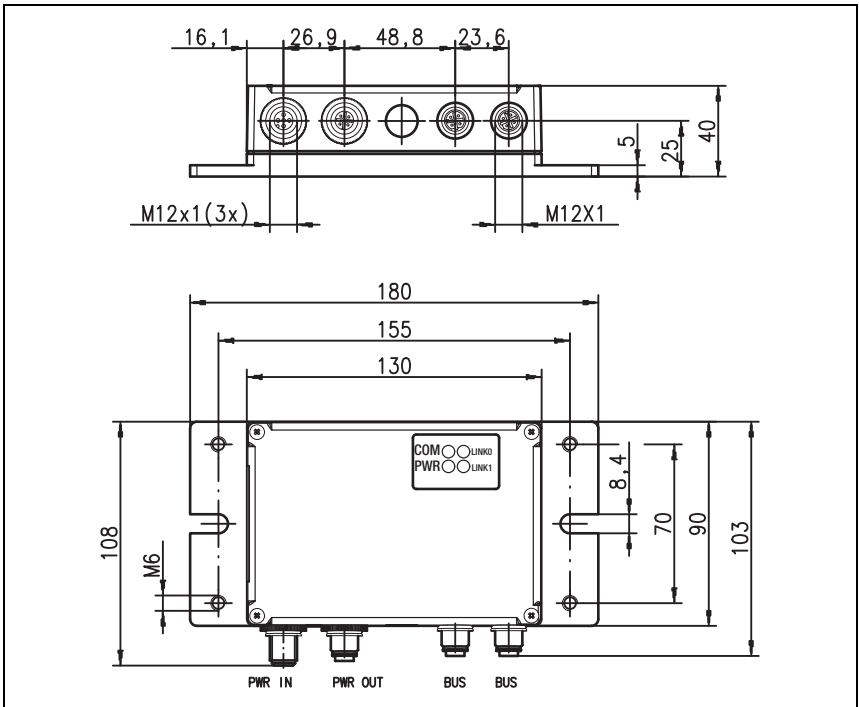

Figure 5.1: MA 208*i* dimensioned drawing

5.3 Type overview

The following versions of the MA 2xx*i* gateway family are available for facilitating the integration of Leuze RS 232 devices in the various fieldbus types.

Fieldbus	Device type	Part no.
PROFIBUS DP V0	MA 204 <i>i</i>	50112893
Ethernet TCP/IP	MA 208 <i>i</i>	50112892
PROFINET-IO RT	MA 248 <i>i</i>	50112891
DeviceNet	MA 255 <i>i</i>	50114156
CANopen	MA 235 <i>i</i>	50114154
EtherCAT	MA 238 <i>i</i>	50114155
EtherNet/IP	MA 258 <i>i</i>	50114157

Table 5.1: Type overview MA 2xx*i*

6 Installation and mounting

6.1 Storage, transportation

**Attention!**

When transporting or storing, package the device so that it is protected against collision and humidity. Optimal protection is achieved when using the original packaging. Heed the required environmental conditions specified in the technical data.

Unpacking

- ↳ Check the packaging for any damage. If damage is found, notify the post office or shipping agent as well as the supplier.
- ↳ Check the delivery contents using your order and the delivery papers:
 - Delivered quantity
 - Device type and model as indicated on the name plate
 - Brief manual

The name plate provides information as to what MA 2xx*i* type your device is. For specific information, please refer to the package insert or chapter 14.2.

Name plate of the connector unit

Figure 6.1: MA 208*i* device name plate

- ↳ Save the original packaging for later storage or shipping.

If you have any questions concerning your shipment, please contact your supplier or your local Leuze electronic sales office.

- ↳ Observe the applicable local regulations when disposing of the packaging materials.

6.2 Mounting

The gateway mounting plate MA 208*i* can be mounted in two different ways:

- using four threaded holes (M6) or
- using two M8 screws on the two lateral grooves.

Fastening by means of four M6 or two M8 screws



Figure 6.2: Fastening options

6.3 Device arrangement

Ideally, the MA 208*i* should be mounted so that it is easily accessible near the Ident device in order to ensure good operability - e.g., for configuring the connected device.

6.3.1 Selecting a mounting location

In order to select the right mounting location, several factors must be considered:

- The permissible cable lengths between the MA 208*i* and the host system depending on which interface is used.
- The housing cover should be easily accessible, so that the internal interfaces (device interface for connecting the Leuze device via PCB connectors, service interface) and other operational controls are easy to reach.
- Maintaining the required environmental conditions (temperature, humidity).
- Lowest possible chance of damage to the MA 208*i* by mechanical collision or jammed parts.

6.4 Cleaning

↳ *Clean the housing of the MA 208*i* with a soft cloth after mounting. Remove all packaging remains, e.g. carton fibers or Styrofoam balls.*



Attention!

Do not use aggressive cleaning agents such as thinner or acetone for cleaning the device.

7 Electrical connection

The fieldbus gateways MA 2xx*i* are connected using variously coded M12 connectors.

An RS 232 device interface allows the respective devices to be connected with system connectors. The device cables are equipped with a prefabricated PG cable gland.

Coding varies and the design is implemented as either socket or connector depending on the HOST (fieldbus) interface and function. For the exact design, refer to the corresponding description of the MA 2xx*i* device type.



Notice!

The corresponding mating connectors and ready-made cables are available as accessories for all cables. For further information, see chapter 14 "Type overview and accessories".



Figure 7.1: Location of the electrical connections

7.1 Safety notices for the electrical connection



Attention!

Before connecting the device please ensure that the supply voltage matches the value printed on the nameplate.

Connection of the device and cleaning must only be carried out by a qualified electrician.

Ensure that the functional earth (FE) is connected correctly. Unimpaired operation is only guaranteed when the functional earth is connected properly.

If faults cannot be corrected, the device should be removed from operation and protected against possible commissioning.



Attention!

For UL applications, use is only permitted in class 2 circuits in accordance with the NEC (National Electric Code).



The fieldbus gateways are designed in accordance with safety class III for supply by PELV (protective extra-low voltage with reliable disconnection).



Notice!

Protection class IP65 is achieved only if the connectors and caps are screwed into place!

7.2 Electrical connection

The MA 208*i* features two M12 connectors/sockets for voltage supply; each is A-coded. The voltage supply (**PWR IN**) as well as the switching inputs/outputs (**PWR OUT** or **PWR IN**) are connected there. The number and function of the switching inputs/outputs is dependent on the connected end device. Two additional M12 sockets are used for connection to the fieldbus. Both of these connections are D-coded.

An internal RS 232 interface is used for connecting the respective Leuze device. Another internal RS 232 interface functions as a service interface for configuring the connected device via a serial null modem cable.

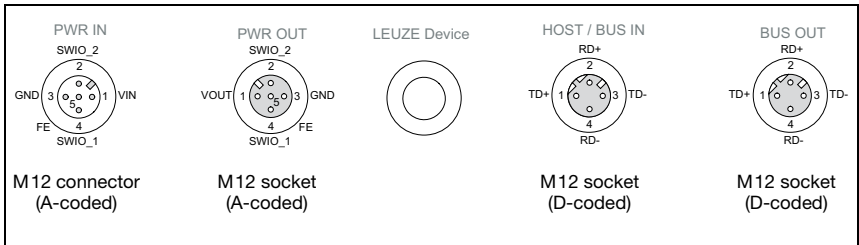

Figure 7.2: MA 208*i* connections

Described in detail in the following are the individual connections and pin assignments.



Attention!

Voltage supply and bus cable are coded in the same way. Please observe the printed connection designations

7.2.1 PWR IN – voltage supply / switching input/output

PWR IN (5-pin connector, A-coded)			
	Pin	Name	Remark
<p>PWR IN SWIO_2 2 VIN 3 GND 4 SWIO_1 5 FE M12 connector (A-coded)</p>	1	VIN	Positive supply voltage +18 ... +30VDC
	2	SWIO_2	Switching input/switching output 2
	3	GND	Negative supply voltage 0VDC
	4	SWIO_1	Switching input/switching output 1
	5	FE	Functional earth
	Thread	FE	Functional earth (housing)

Table 7.1: PWR IN pin assignment

**Notice!**

The designation and function of the SWIO depends on the connected device. Please observe the following table!

Device	PIN 2	PIN 4
BCL 22/BCL 32	SWOUT_1	SWIN_1
BCL 8	SW_0	SW_I
Hand-held scanner/BCL 90	n.c.	n.c.
RFM/RFU/RFI	SWOUT_1	SWIN_1
LSIS 122	SWOUT	SWIN
LSIS 4x2/BCL 500	configurable IO 1 / SWIO 3 IO 2 / SWIO 4	configurable
KONTURflex	n.c.	n.c.
ODSL 9, ODSL 96B	Q1	n.c.
ODSL 30	Q1	active/reference (on SWIN_1, PWRIN)

Table 7.1: Device-specific function of the SWIOs

Supply voltage**Attention!**

For UL applications, use is only permitted in class 2 circuits in accordance with the NEC (National Electric Code).



The fieldbus gateways are designed in accordance with safety class III for supply by PELV (protective extra-low voltage with reliable disconnection).

Connecting functional earth FE**Notice!**

Ensure that the functional earth (FE) is connected correctly. Unimpaired operation is only guaranteed when the functional earth is connected properly. All electrical disturbances (EMC couplings) are discharged via the functional earth connection.

Switching input/output

The MA 208*i* is equipped with the **SWIO_1** and **SWIO_2** switching inputs/outputs. This is located on the PWR IN M12 connector and on the PWR OUT M12 connector. The connection of the switching inputs/outputs from PWR IN to PWR OUT can be interrupted by means of a jumper. In this case, only the switching input and output on PWR IN are active.

The function of the switching inputs and outputs is dependent on the connected Leuze device. Detailed information on this topic can be found in the respective operating instructions.

7.2.2 PWR OUT switching input/output

PWR OUT (5-pin socket, A-coded)			
 <p>PWR OUT</p> <p>SWIO_2</p> <p>2</p> <p>VOUT 1 3 GND</p> <p>5</p> <p>4 FE</p> <p>SWIO_1</p> <p>M12 socket (A-coded)</p>	Pin	Name	Remark
	1	VOUT	Voltage supply for additional devices (VOUT identical to VIN at PWR IN)
	2	SWIO_2	Switching input/switching output 2
	3	GND	GND
	4	SWIO_1	Switching input/switching output 1
	5	FE	Functional earth
	Thread	FE	Functional earth (housing)

Table 7.2: PWR OUT pin assignment



Notice!

The maximum admissible current of the PWR OUT and IN connectors is maximum 3A. To be subtracted from this is the current consumption of both the MA and of the connected end device.

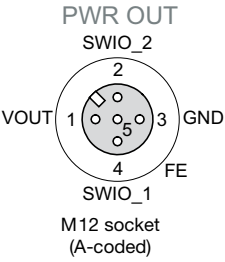
The function of the switching inputs and outputs is dependent on the connected Leuze device. Detailed information on this topic can be found in the respective operating instructions.

On delivery, the SWIO 1/2 are connected in parallel on PWR IN/OUT. This connection can be separated with a jumper.

7.3 BUS IN

The MA 208*i* makes an Ethernet interface available as host interface.

BUS IN (4-pin socket, D-coded)			
 <p>HOST / BUS IN</p> <p>RD+</p> <p>2</p> <p>TD+ 1 3 TD-</p> <p>4</p> <p>RD-</p> <p>M12 socket (D-coded)</p>	Pin	Name	Remark
	1	TD+	Transmit Data +
	2	RD+	Receive Data +
	3	TD-	Transmit Data -
	4	RD-	Receive Data -
Thread	FE	Functional earth (housing)	

Table 7.3: Pin assignment HOST / BUS IN

↳ For the host connection of the MA 208*i*, the "KB ET - ... - SA-RJ45" ready-made cables are preferred, see table 14.4 Bus connection cable for the MA 208*ion* page 64.

Ethernet TCP/IP cable assignments

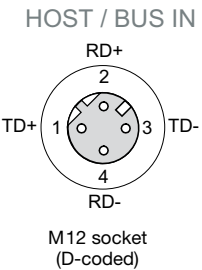
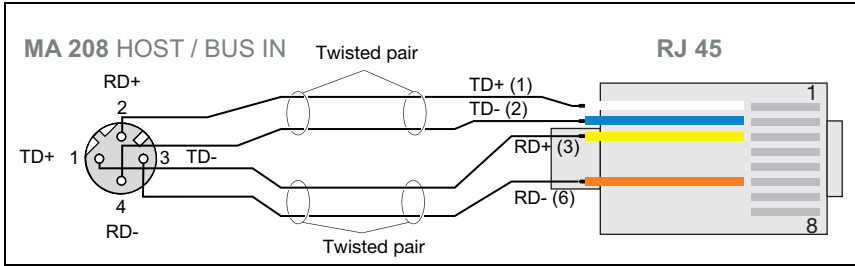

Figure 7.3: HOST/BUS IN cable assignments on RJ-45 (shown here is the device connection)



Notice for connecting the Ethernet TCP/IP interface!

Ensure adequate shielding. The entire connection cable must be shielded and earthed. The RD+/RD- and TD+/TD- wires must be stranded in pairs. Use CAT 5 cable for the connection.

7.4 BUS OUT

To set up an Ethernet network with other participants with linear topology, the MA 208*i* makes available another Ethernet interface. The use of this interface drastically reduces the cabling requirements, as only the first MA 208*i* requires a direct connection to the switch, via which it can communicate with the host. All other MA 208*i* are connected in series to the first MA 208*i*,(see figure 4.5 on page 19).

BUS OUT (4-pin socket, D-coded)			
	Pin	Name	Remark
<p>BUS OUT RD+ 2 TD+ 1 3 TD- 4 RD- M12 socket (D-coded)</p>	1	TD+	Transmit Data +
	2	RD+	Receive Data +
	3	TD-	Transmit Data -
	4	RD-	Receive Data -
	Thread	FE	Functional earth (housing)

Table 7.4: Pin assignment HOST/BUS OUT

↳ For the host connection of the MA 208*i*, the "KB ET - ... - SSA" ready-made cables are preferred, see table 14.4 Bus connection cable for the MA 208*i* on page 64.

If you use user-configurable cables, note the following:



Notice!

Ensure adequate shielding. The entire connection cable must be shielded and earthed. The signal lines must be stranded in pairs. Use CAT 5 cable for the connection.



Notice!

For the MA 208*i* as standalone device or as the last participant in a linear topology, termination on the BUS OUT socket is **not** mandatory!

7.5 Device interfaces

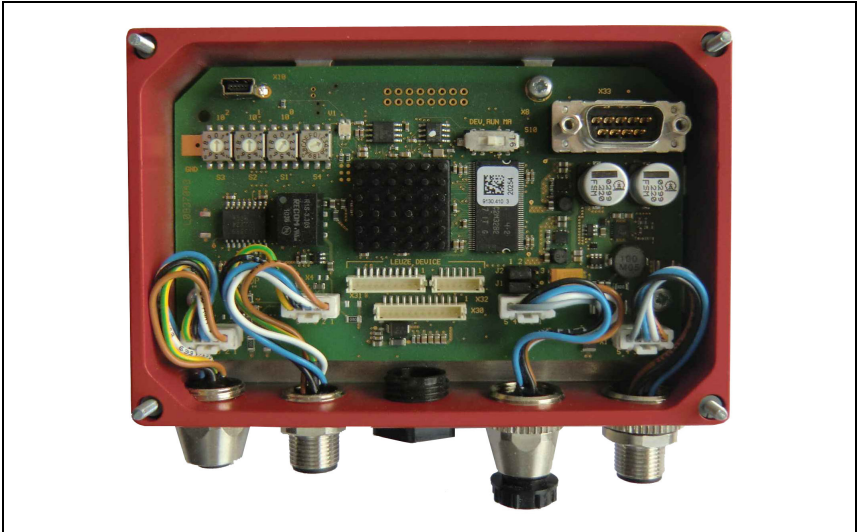

Figure 7.4: Open the MA 208*i*

7.5.1 RS 232 device interface (accessible after opening the device, internal)

The device interface is prepared for the system plugs (PCB connectors) for Leuze devices RFI xx, RFM xx, BCL 22 as well as BCL 32, VR with KB 031.

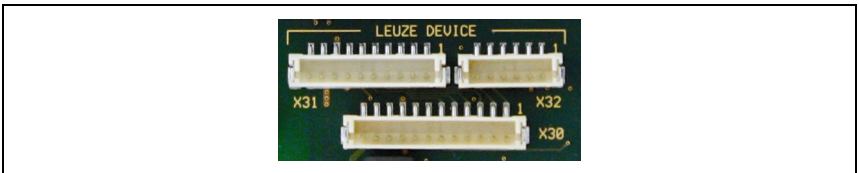

Figure 7.5: RS 232 device interface

The standard devices are connected with 6- or 10-pin connector piece to X31 or X32, respectively. For hand-held scanners, BCL 8 and BPS 8 with 5VDC supply (from the MA) on pin 9, the 12-pin X30 PCB connection is available as well.

By using an additional cable (cf. "Type overview and accessories" on page 61), the system connection can be established on M12 or 9-pin Sub-D, e.g., for hand-held scanners.

7.5.2 Service interface (internal)

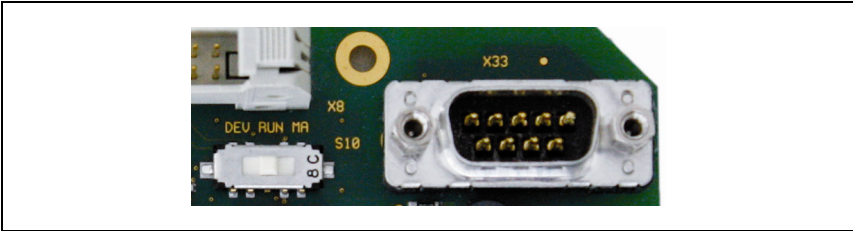

Figure 7.6: RS 232 service switch and service interface

Following activation, this interface enables access via the RS 232 to the connected Leuze device and the MA for configuration using the 9-pin Sub-D. The connection between the fieldbus interface and the device interface is switched off during access. The fieldbus itself is, however, not interrupted as a result.

The service interface can be accessed once the MA 208*i* housing cover has been removed and features a 9-pin Sub-D connector (male). A crossed RS 232 connection cable is required to make the RxD, TxD and GND connections. A hardware handshake via RTS, CTS is not supported at the service interface.

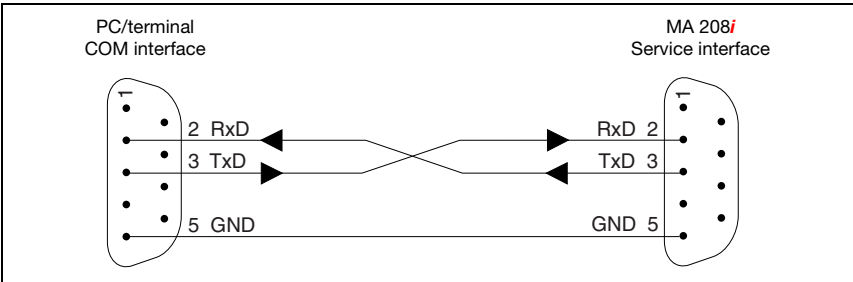

Figure 7.7: Connecting the service interface to a PC/terminal



Attention!

For the service PC to function, the RS 232 parameters must be the same as those of the MA. The Leuze standard setting of the interface is 9600Bd, 8N1 and STX, data, CR, LF.



Notice!

To configure the devices connected to the external interface, e.g., BCL 8 (JST plug connector "X30"), a cable specially configured for this purpose is necessary. The service switch must be in the "DEV" or "MA" position (Service Leuze device/MA).

7.6 Ethernet wiring

A Cat. 5 Ethernet cable should be used for wiring.

For the connection technology transition from M12 to RJ45, a "KDS ET M12 / RJ 45 W - 4P" adapter is available that lets you connect standard network cables.

If no standard network cables are to be used (e.g., due to lacking IP... protection class), you can use the "KB ET - ... - SA" user-configurable cables on the side of the MA 208*i*, see table 14.4 Bus connection cable for the MA 208ion page 64.

The individual MA 208*i* devices in a linear topology are connected with the "KB ET - ... - SSA" cable, see "Bus connection cable for the MA 208i" on page 64.

For unavailable cable lengths, you can configure your cables yourself. When doing so, make certain that you connect **TD+** on the M12 connector with **RD+** on the RJ-45 connector and **TD-** on the M12 connector with **RD-** on the RJ-45 connector, respectively, etc.



Notice!

Use the recommended connectors / sockets or the ready-made cables (see chapter 14 "Type overview and accessories").

For further information on the topologies, see chapter 4.5.1 "Ethernet".

7.7 Cable lengths and shielding

👉 Observe the following maximum cable lengths and shielding types:

Connection	Interface	Max. cable length	Shielding
MA 208 <i>i</i> – Service	RS 232	10m	not necessary
MA 208 <i>i</i> – Host	Ethernet	100m	absolutely required, shielded
Network from the first MA 208 <i>i</i> to the last MA 208 <i>i</i>	Ethernet	the maximum segment length must not exceed 100 m for 100Base-TX Twisted Pair (min. Cat. 5)	absolutely required, shielded
MA 208 <i>i</i> – Power supply unit		30m	not necessary
Switching input		10m	not necessary
Switching output		10m	not necessary

Table 7.5: Cable lengths and shielding

8 Status displays and operational controls







Figure 8.1: LED indicators on the MA 208*i*

8.1 LED status indicators



8.1.1 LED indicators on the circuit board

LED (Status)





	off	Device OFF - no operating voltage or device defect
	continuous green light	Device ok - readiness for operation
	continuous orange light	Device error / firmware available
	flashing green-orange	Device in boot mode - no firmware

8.1.2 LED indicators on the housing



COM LED

COM 	continuous green light	Bus operation ok - network mode ok - connection and communication to the host established
COM 	continuous red light	Configuration error - network error - no connection established - no communication possible



PWR LED

PWR 	off	Device OFF - no operating voltage or device error for details, see chapter 15 "Diagnostics and troubleshooting"
PWR 	continuous green light	Device ok - self test successfully finished - ready
PWR 	flashing green	Device ok, device in service mode
PWR 	flashing red	Configuration error - baud rate or address incorrect

LINK 0/RX/TX 0 LED

 Link 0 RX/TX 0	continuous green light	LINK0 - connection exists
 Link 0 RX/TX 0	flashing yellow	RX/TX0 - data exchange

LINK 1/RX/TX 1 LED

 Link 1 RX/TX 1	continuous green light	LINK1 - connection exists
 Link 1 RX/TX 1	flashing yellow	RX/TX1 - data exchange

8.2 Internal interfaces and operational controls

8.2.1 Overview of operational controls of the

The operational controls of the MA 208*i* are described in the following. The figure shows the MA 208*i* with opened housing cover.

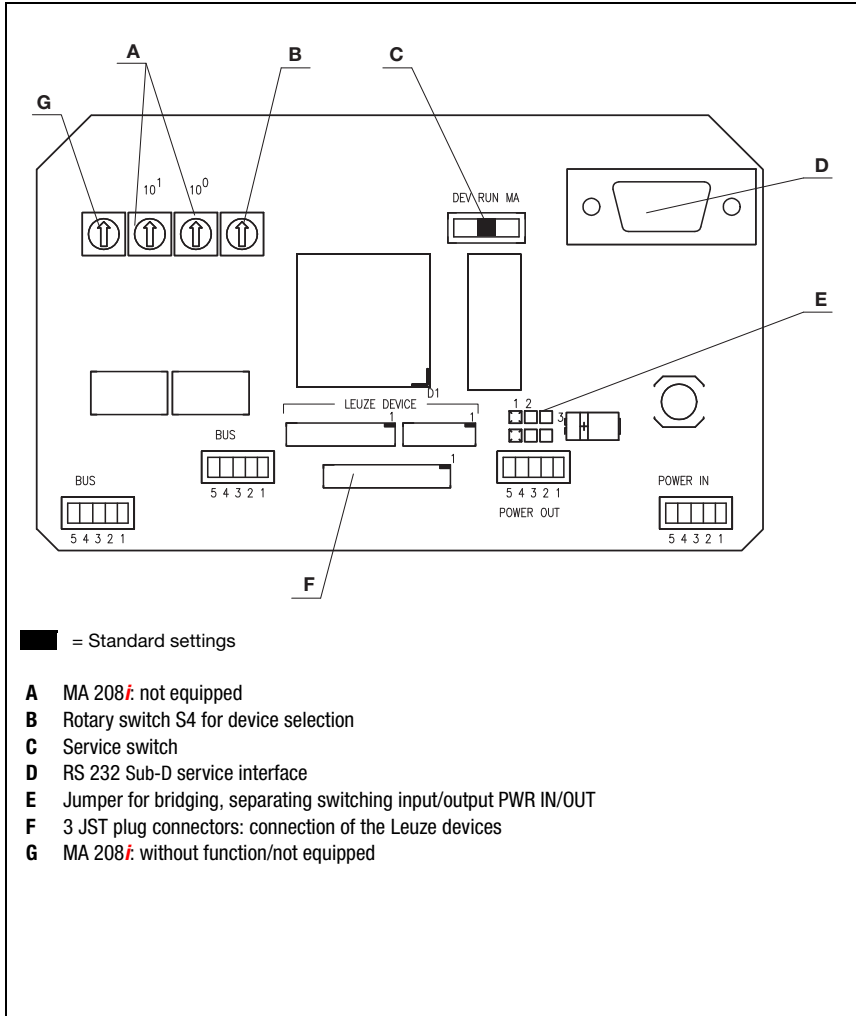

Figure 8.2: Front view: operational controls of the MA 208*i*

Circuit board element desig.	Function
X1 Operating voltage	PWR IN M12 connector for operating voltage (18 ... 30VDC) MA 208 <i>i</i> and connected Leuze device xx
X2 Output voltage	PWR OUT M12 connector for other devices (MA, BCL, sensor, ...) VOUT = VIN max. 3A
X4 HOST interface	BUS IN HOST interface for connecting to the fieldbus
X5 HOST interface	BUS OUT Second BUS interface for creating a network with other participants in a linear topology
X30 Leuze device	JST plug connector with 12 pins Connection of the Leuze devices with 5V / 1 A (BCL 8, BPS 8 and hand-held scanner)
X31 Leuze device	JST plug connector with 10 pins Connection of the Leuze devices (BCL, RFI, RFM,...) Pin VINBCL with standard setting = V+ (18 - 30V)
X32 Leuze device	JST plug connector with 6 pins Connection of the Leuze devices (BCL, RFI, RFM,...) Pin VINBCL with standard setting = V+ (18 - 30V)
X33 RS 232 service interface	9-pin SUB-D connector RS 232 interface for service/setup operation. Enables the connection of a PC via serial null modem cable for configuring the Leuze device and the MA 208 <i>i</i> .
S4 Rotary switch	Rotary switch (0 ... F) for device selection Standard setting = 0
S10 DIP switch	Service switch Switch between service Leuze device (DEV), service fieldbus gateway (MA) and operation (RUN). Standard setting = operation.
J1, J2 Jumper	Bridging, separating switching input/output (interruption of connection between the two PWR M12 connectors of the SWIO 1 / SWIO 2)

8.2.2 Connector X30 ... connectors

PCB connectors **X30 ... X32** are available in the MA 208*i* for connecting the respective Leuze devices via RS 232.

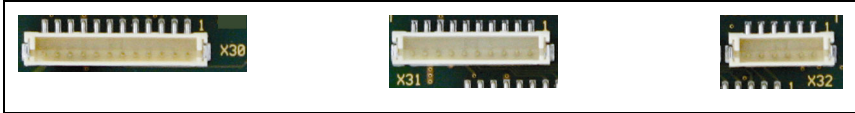

Figure 8.3: Connections for Leuze devices



Attention!

Several Leuze devices may not be connected to the MA 208*i* simultaneously, as only one RS 232 interface can be operated.

8.2.3 RS 232 service interface – X33

The **X33** RS 232 interface facilitates the configuration of the Leuze device and the MA 208*i* via PC, which is connected by means of a serial null modem cable.

X33 pin assignment – service connector

SERVICE (9-pin SUB-D connector)			
	Pin	Name	Remark
	2	RXD	Receive Data
	3	TXD	Transmit Data
	5	GND	Functional earth

Table 8.1: SERVICE pin assignment

8.2.4 S10 service switch

The **S10** DIP switch can be used to select between the "operation" and "service" modes, i.e. you switch between the following options here:

- Operation (RUN) = default setting
- Service Leuze device (DEV) and
- Service fieldbus gateway (MA)

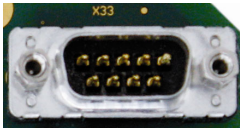
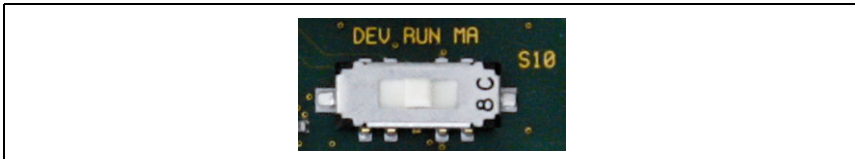

Figure 8.4: DIP switch service - operation

For further information on the corresponding options, see chapter 4.4 "Operating modes".

8.2.5 Rotary switch S4 for device selection

The **S4** rotary switch is used to select the Leuze end device.



Figure 8.5: Rotary switch for device selection

The following switch positions are assigned to the Leuze devices:

Leuze device	Switch position
Standard setting	
Other RS 232 devices such as KONTURflex QUATTRO	0
BCL 8	1
BCL 22	2
BCL 32	3
BCL 300i, BCL 500i	4
BCL 90	5
LSIS 122	6

Leuze device	Switch position
LSIS 4x2i	7
Hand scanner	8
RFID (RFI xx, RFM xx, RFU xx)	9
BPS 8	A
AMS, ODS 9, ODSL 30, ODSL 96B	B
MA 3x	C
Reset to factory setting	F

The gateway is set via the switch position on the Leuze device. If the switch position is changed, the device must be restarted, since the switch position is only queried after switching off completely and then restarting the device.



Notice!

In switch position "0", a distance of >20ms must be maintained between two telegrams so they can be distinguished from one another.

The parameters of the Leuze end devices are described in chapter 16.

9 Configuration

The connected device is normally configured via the service interface of the gateway with the help of a suitable configuration program. In these tools, the MA 208*i* has been created as a device to enable setting of gateway parameters as well in the usual way via the service interface.

The respective configuration programs – e.g. for bar code readers the BCL-Config, for RFID devices the RF-Config etc. – and the associated documentation is provided on the Leuze home page in the Download area:

[www.leuze.com \ download \ identify](http://www.leuze.com/download/identify)



Notice!

In order to display the help texts, a PDF viewer program (not included in the delivery contents) must also be installed. For important information on configuring and on the configurable functions, please refer to the description of the respective device.

9.1 Connecting the service interface

The RS 232 service interface is connected after opening the device cover of the MA 208*i* via the 9-pin Sub-D and a cross-wired null modem cable (RxD/TXD/GND). For connection, see chapter "Service interface (internal)" on page 32.

The service interface is activated with the help of the service switch and establishes a direct connection to the connected device with the "DEV" (Leuze device) or "MA" (gateway) setting.

9.2 Reading out information in Service mode

↳ *After starting up in the "RUN" switch position, set the service switch of the MA to the "MA" position.*

↳ *Now start one of the following terminal programs: e.g., BCL, RF, BPS Config.*

Alternatively, you can also use the Windows tool "Hyperterminal".

↳ *Start the program.*

↳ *Select the correct COM port (e.g., COM1) and set the interface as follows:*

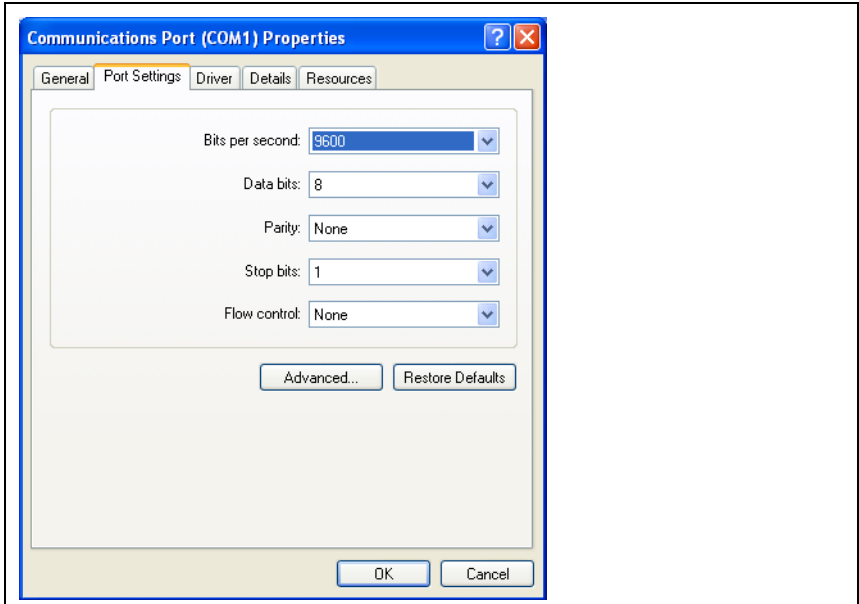

Figure 9.1: COM port settings



Notice!

Observe that STX, data, CR, LF framing must be set on the PC terminal program so that communication is possible with the connected Leuze device.

Commands

You can now call up information on the MA 208*i* by sending the following commands.

v	General service information.
s	Enable memory mode for the last frames.
l	The memory mode shows the last RX and TX frames for ASCII and fieldbus.

Table 9.1: Available commands

Information

Version	Version information.
Firmware date	Firmware date.

Table 9.2: General firmware information

Selected scanner	Currently selected Leuze device (selected via switch S4).
Gateway mode	Transparent or Collective mode.
State and Control Bytes Used	Displays whether the status and control bytes can be used.
Separator Length	Display of the separator length.
Separator (hex)	Display of the set separator.
Ring buffer fill level	Current fill level of the ring memory in Collective mode (ASCII->Fieldbus). 1024 bytes max.
Received ASCII Frames	Number of received ASCII frames.
ASCII Framing Error (GW)	Number of received framing errors.
Number of Received CTB's	Number of CTB commands.
Number of Received SFB's	Number of SFB commands.
Command-Buffer fill level	Current fill level of the ring memory in Command mode (fieldbus->ASCII). 1024 bytes max.
Number of send serial frames	Number of serial frames sent without CTB/SFB.
Number of send fieldbus frames	Number of frames sent via the fieldbus.
Number of invalid commands	Number of invalid commands.
Number of serial stack send errors	Number of frames that the serial memory could not send.
Number of good serial send frames	Number of frames that the serial memory sent successfully.

Table 9.3: General gateway information

ND	Current status of ND bit.
Data loss	Current status of data loss bit.

Table 9.4: Current states of the status and control bits

ASCII start byte	Currently configured start byte (dependent on switch position S4).
ASCII end byte1	Currently configured stop byte 1 (dependent on switch position S4).
ASCII end byte2	Currently configured stop byte 2 (dependent on switch position S4).
Rotary switch used	Rotary switch used.
ASCII baud rate	Currently configured baud rate (dependent on switch position S4).
ASCII framing	Character length, parity, stop bit(s).
ASCII warm start status	Indicates whether the ASCII memory has detected and accepted a valid configuration.

Table 9.5: ASCII configuration

Lost packets while TCPIP in progress	Lost packets.
DHCP	DHCP.
IP address	Displays the set IP address.
Gateway address	Displays the set gateway address.
Network mask	Displays the set network mask.
TCP-UDP mode	Displays the configured mode: TCP client, TCP server or UDP.
Remote IP address	Displays the IP address of the communication partner.
Local port	Displays the local port address.
Remote port	Displays the port address of the communication partner.

Table 9.6: MA 208*i* communication parameters

10 Telegram

10.1 Structure of the fieldbus telegram

All operations are performed by control and status bits. Two bytes of control information and two bytes of status information are available for this purpose. The control bits are a part of the output module and the status bits are a part of the input bytes. The data starts with the third byte.

If the actual data length is longer than the data length configured in the gateway, only part of the data is transmitted; the remaining data is lost. In this case, the DL (data loss) bit is set.

The following telegram structure is used between **PLC -> fieldbus gateway**:

7	6	5	4	3	2	1	0	
ND	Address 4	Address 3	Address 2	Address 1	Address 0	Broadcast	Command mode	Control byte 0
				Reserved	Reserved		Reserved	Control byte 1
Data byte / parameter byte 0								Data
Data byte / parameter byte 1								
...								

This telegram structure is used between **fieldbus gateway -> PLC**:

7	6	5	4	3	2	1	0	
ND	Reserved	DL	Reserved	Reserved	SMA		Reserved	Status byte 0
DLC7	DLC6	DLC5	DLC4	DLC3	DLC2	DLC1	DLC0	Status byte 1
Data byte / parameter byte 0								Data
Data byte / parameter byte 1								
...								

Only the data part with the corresponding frame (e.g., STX, CR & LF) is then transmitted between the fieldbus gateway and the Leuze end device. The two control bytes are processed by the fieldbus gateway.

The corresponding control and status bits and their meaning are specified in section 10.2 and section 10.3.

Further information on the broadcast control bytes and address bits 0 ... 4 can be found in chapter "Modular interfacing unit MA 3x (S4 switch position C)" on page 81.

10.2 Description of the input bytes (status bytes)

10.2.1 Structure and meaning of the input bytes (status bytes)

7	6	5	4	3	2	1	0	
ND	Reserved	DL	Reserved	Reserved	SMA		Reserved	Status byte 0
DLC7	DLC6	DLC5	DLC4	DLC3	DLC2	DLC1	DLC0	Status byte 1
Data byte / parameter byte 0								Data
Data byte / parameter byte 1								
...								

Table 10.1: Structure of the input bytes (status bytes)

Bits of the input byte (status byte) 0

Bit no.	Designation	Meaning
2	SMA	Service mode active(service mode activated)
5	DL	Data loss
7	ND	New data only in Transparent mode

Bits of the input byte (status byte) 1

Bit no.	Designation	Meaning
0 ... 7	DLC0 ... DLC7	Data Length Code (length of the following user data)



Notice!

T-bit means toggle bit, i.e. this bit changes its state on each event ("0" → "1" or "1" → "0").

10.2.2 Detailed description of the bits (input byte 0)

Bit 2: Service mode active: SMA

Input data	Description	Addr.	Data type	Value range	Default
SMA	Service mode active (SMA) The SMA bit is set if the service switch is set to "MA" or "DEV", i.e. if the device is in either fieldbus gateway or Leuze device service mode. This is also indicated by a flashing PWR LED on the front side of the device. Upon changing to the normal operating mode "RUN", the bit is reset.	0.2	Bit	0: Device in operating mode 1: Device in service mode	0h

Bit 5: Data loss: DL

This bit is important for monitoring data transmission in Transparent and Collective mode.

Input data	Description	Addr.	Data type	Value range	Default
DL	Data loss (Data transmission monitoring) This bit is set if gateway data could not be sent to the PLC and were lost. Furthermore, this bit is set in case the configured data frame, e.g. 8 bit, should be smaller than the data to be transmitted to the PLC, e.g. bar code with 20 digits. In this case, the first 8 digits are transmitted to the PLC, the rest are truncated and are lost. In this process, the Data loss bit is also set.	0.6	Bit	0->1: Data loss	0

Bit 7: New data: ND

This bit is only relevant in Transparent mode.

Input data	Description	Addr.	Data type	Value range	Default
ND	New data (new data) This bit is toggled on each data set that is sent from the gateway to the PLC. This can be used to differentiate between multiple, identical data sets that are sent to the PLC.	0.7	Bit	0->1; 1->0: On each status change for new data	0

10.2.3 Detailed description of the bits (input byte 1)

Bit 0 ... 7: Data length code: DLC0 ... DLC7

Input data	Description	Addr.	Data type	Value range	Default
DLC0 ... DLC7	Data length code (number of user data in bytes) Stored in these bits is the number of user data bytes transmitted to the PLC which follow.	1.0 ... 1.7	Bit	1 _h (00001 _b) ... FF _h (00255 _d)	0h (00000b)

10.3 Description of the output bytes (control bytes)

10.3.1 Structure and meaning of the output bytes (control bytes)

7	6	5	4	3	2	1	0	
ND	Address 4	Address 3	Address 2	Address 1	Address 0	Broadcast	Command mode	Control byte 0
				Reserved	Reserved	Reserved	Reserved	Control byte 1
Data byte 1								Data
Data byte 2								
...								

Table 10.2: Structure of the output bytes (control bytes)

Bits of the output byte (control byte) 0

Bit no.	Designation	Meaning
0	Command mode	Command mode
1	Broadcast	Broadcast (only relevant with a connected MA 3x)
2 ... 6	Address 0 .. 4	Address bits 0 .. 4 (only relevant with a connected MA 3x)
7	ND	New data

10.3.2 Detailed description of the bits (output byte 0)

Bit 0: Command mode: Command mode

Output data	Description	Addr.	Data type	Value range	Default
Command mode	Command mode This bit is used to activate Command mode. In Command mode, no data is sent by the PLC to the Leuze end device via the gateway. In Command mode, various bits that execute corresponding commands depending on the selected Leuze device can be set in the data- or parameter field. For further information, see chapter 11.1.2 "Command mode".	0.0	Bit	0: Default, transparent data transmission 1: Command mode	0

The following two control bits ("Bit 1: Broadcast: Broadcast" on page 48 and "Bits 2 ... 6: address bits 0 .. 4: address 0 .. 4" on page 48) are only relevant with a connected MA 3x. With other devices, these fields are ignored.

Bit 1: Broadcast: Broadcast

Output data	Description	Addr.	Data type	Value range	Default
Broadcast	Broadcast A broadcast only functions with a multiNet network connected via the MA 3x. If this bit is activated, the gateway automatically adds the broadcast command "00B" before the data. This is directed at all participants in the multiNet.	0.1	Bit	0: No broadcast 1: Broadcast	0

Bits 2 ... 6: address bits 0 .. 4: address 0 .. 4

Output data	Description	Addr.	Data type	Value range	Default
Address 0..4	Address bits 0 .. 4 As with the broadcast command, individual devices in the multiNet can also be addressed via the MA 3x. In this case, the corresponding address of the device precedes the data field telegram.	0.2 ... 0.6	Bit	00000: Addr. 0 00001: Addr. 1 00010: Addr. 2 00011: Addr. 3 ...	0

Bit 7: New data: ND

Output data	Description	Addr.	Data type	Value range	Default
ND	New data This bit is needed if several identical pieces of data are to be sent in sequence.	0.7	Bit	0->1; 1->0: On each status change for new data	0

11 Modes

11.1 Functionality of the data exchange

Transparent mode (standard setting)

In Transparent mode, all data is sent 1:1 and directly by the serial end device to the PLC. It is not necessary to use status and control bits here. However, only data bytes possible for **one** transmission cycle are transmitted - all others are lost.

The distance between two successive telegrams (without frame) must be more than 20ms, since there is otherwise no clear separation between them.

ASCII characters are typically expected as data content; under certain circumstances, the MA therefore detects different control characters as invalid characters in the data range and truncates them. At 00_h in the data range, the MA cuts the telegram off because unnecessary bytes are also filled with 00_h.

11.1.1 Writing slave data in Collective mode (PLC -> gateway)

Examples for the activation of a Leuze device

In the data part (starting at byte 2) of the telegram to the gateway, a "+" (ASCII) is sent for activation.

This means that the hex value "2B" (corresponds to a "+") is to be entered in control or output byte 2. To deactivate the reading gate, a "2D" (hex) must be used instead (corresponds to a "-" ASCII).

7	6	5	4	3	2	1	0	
ND	Address 4	Address 3	Address 2	Address 1	Address 0	Broadcast	Command mode	Control byte 0
				Reserved	Reserved		Reserved	Control byte 1
Data byte 1								Data
Data byte 2								
...								
7	6	5	4	3	2	1	0	
0	0	0	0	0	0	0	0	Output byte 0
0	0	0	0	0	0	0	0	Output byte 1
0	0	0	0	0	0	B	2	Output byte 2
0	0	0	0	0	0	0	0	Output byte 3

11.1.2 Command mode

One specific feature is the so-called Command mode, which is defined via the output control byte 0 (bit 0) ... and enables the control of the connected device per bit.

If the command mode is activated (command mode = 1), no data is sent by the PLC to the Leuze end device via the gateway. The data from the MA to the PLC is transmitted in the selected operating mode (Transparent/Collective).

With the Command mode, it is possible to set various device-specific bits in the data- or parameter field that execute the corresponding serial commands (e.g., v, +, -, etc.). If, for example, the version of the Leuze end device is to be queried, the corresponding bit is to be set so that a "v" is sent to the Leuze device with the <STX> v <CR> <LF> frame.

The Leuze end device also answers the gateway with data (e.g. bar code content, NoRead, device version, etc.) in response to most commands. The answer is immediately passed on to the PLC by the gateway.



Notice!

The parameters available for the individual Leuze devices are listed in chapter 16. Command mode cannot be used with hand-held scanners.

Examples for the activation of a Leuze device

In Command mode, control or output byte 0.0 is to be set for activating the Command mode. Only the corresponding bit (control or output byte 2.1) then needs to be set for activating and deactivating the reading gate.

7	6	5	4	3	2	1	0	
0	0	0	0	0	0	0	1	Output byte 0
0	0	0	0	0	0	0	0	Output byte 1
0	0	0	0	0	0	1	0	Output byte 2
0	0	0	0	0	0	0	0	Output byte 3

Command mode sequence diagram

Set control byte 0, bit 0.0 to 1

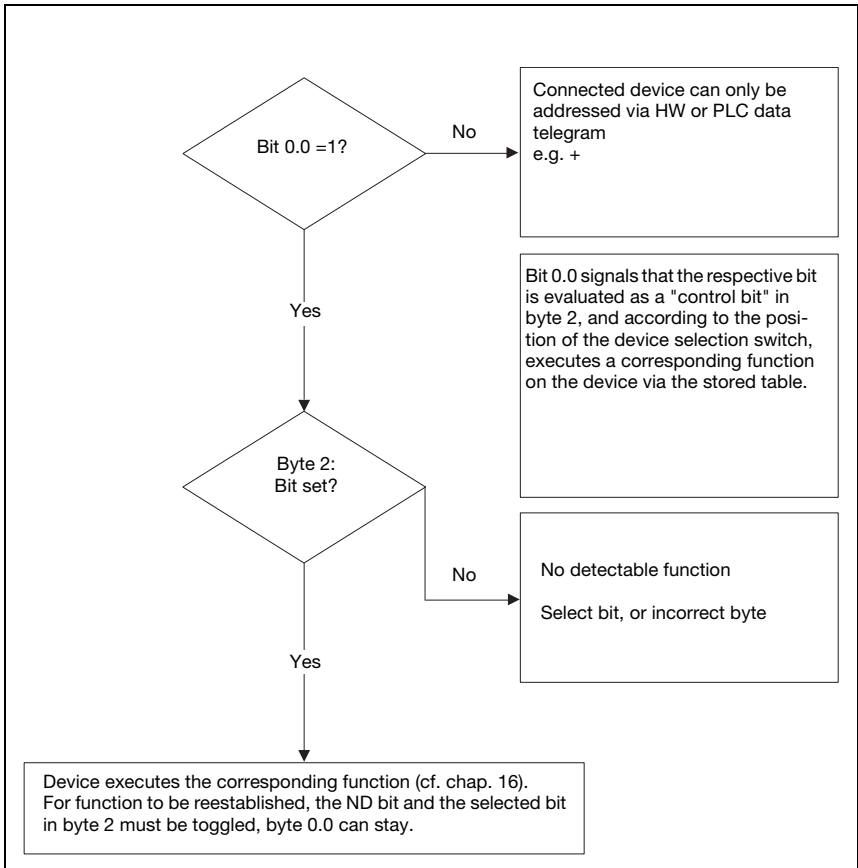

Figure 11.1: Execution of command after activation of the Command mode



Notice!

Further information on fieldbus telegram structure can be found in chapter 10.1. A specification of all usable commands can be found in chapter "Specifications for Leuze end devices" on page 67.

12 Commissioning and configuration

12.1 Measures to be performed prior to the initial commissioning

- ↳ Before commissioning, familiarize yourself with the operation and configuration of the MA 208*i*.
- ↳ **Before connecting the supply voltage**, recheck all connections and ensure that they have been properly made.

The Leuze device must be connected to the internal RS 232 device interface.

Connecting the Leuze device

- ↳ Open the housing of the MA 208*i* and guide the corresponding device cable (e.g., KB 031 for BCL 32) through the middle threaded opening.
- ↳ Connect the cable to the internal device interface (X30, X31 or X32, see chapter 7.5.1).
- ↳ Use rotary switch S4 (see chapter 8.2.5) to select the connected device.
- ↳ Now screw the PG cable gland into the threaded opening to provide strain relief and ensure protection class IP 65.
- ↳ Finally, close the housing of the MA 208*i*.



Attention!

Only then may the supply voltage be applied.

Upon startup of the MA 208*i*, the device selection switch is queried and the gateway automatically sets itself to the Leuze device.

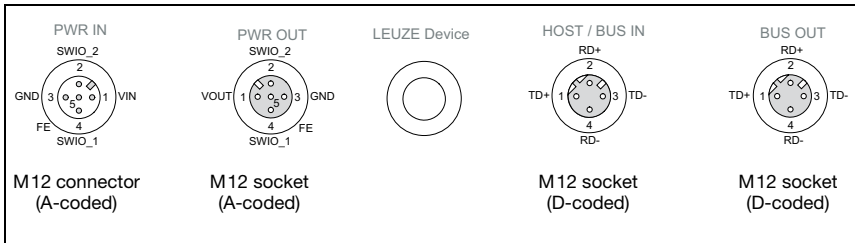

Figure 12.1: Connections of the MA 208*i* seen from below, device on mounting plate

- ↳ Check the applied voltage. It must be in the range between +18V ... 30VDC.

Connecting functional earth FE

- ↳ Ensure that the functional earth (FE) is connected correctly.

Unimpaired operation is only guaranteed when the functional earth is connected properly. All electrical disturbances (EMC couplings) are discharged via the functional earth connection.

On delivery, the SWIO 1/2 are connected in parallel on PWR IN/OUT. This connection can be separated with a jumper.

12.2 Starting the device and setting the communication parameters

First, you must start the device and set the communication parameters of the MA 208*i*. With the communication parameters, you determine how data is exchanged between MA 208*i* and host system, monitor PCs etc.

The communication parameters are **independent** of the topology in which the MA 208*i* is operated (see "Ethernet" on page 18).

On delivery, the MA 208*i* is assigned a permanent IP address.



Notice!

The default address of the MA is 192.168.61.100.

The setting can be adapted via Leuze configuration software BCL-Config, BPS-Config or RF-Config. In these tools, the MA 208*i* has been created as a device to enable setting of parameters in the usual way via the service interface.

12.2.1 Manually setting the IP address

If the IP address of the devices should be permanently set on your system, proceed as follows:

- ↳ *Have the network administrator specify the data for IP address, net mask and gateway address of the MA 208*i*.*
- ↳ *Select the connected device via the device selection switch.*
- ↳ *Apply the supply voltage +18 ... 30VDC (typ. +24VDC); the MA 208*i* starts up.*
- ↳ *Now switch the service switch to "MA".*



Notice!

*The service switch must be in switch position "MA" here so that the MA 208*i* can be addressed via the service interface.*

- ↳ *Connect the serial RS 232 Sub-D interface of the MA 208*i* to the serial interface of your PC.*
- ↳ *Make the necessary settings in the configuration window.*

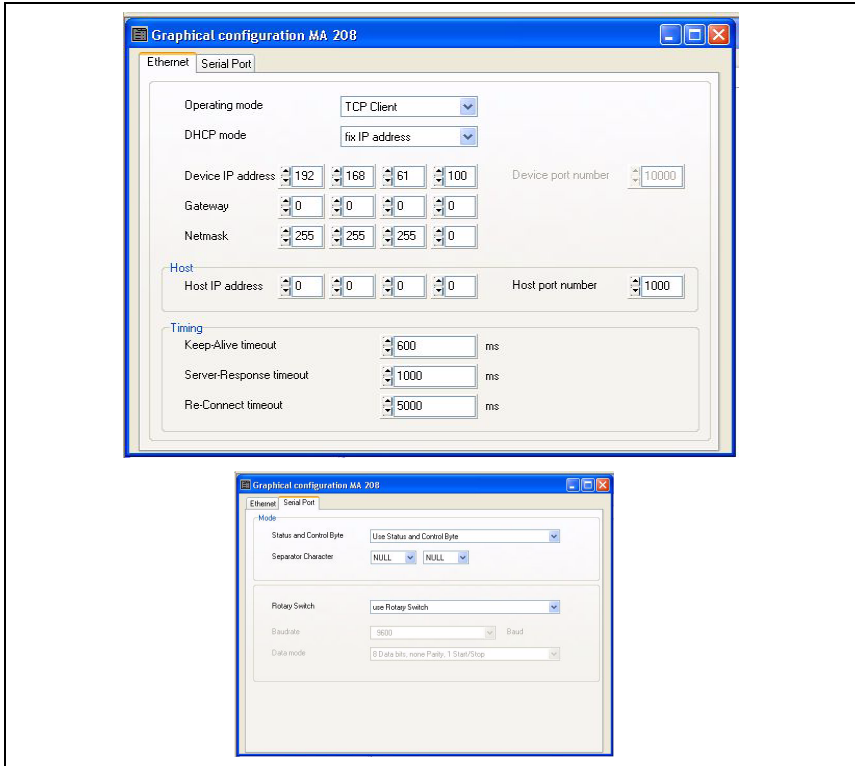

Figure 12.2: Setting the parameters manually

12.2.2 Ethernet host communication

The Ethernet host communication enables the configuration of connections to an external host system. Both UDP as well as TCP/IP (in either client or server mode) can be used. The connection-free UDP protocol is used primarily to transfer process data to the host (monitor operation). The connection-oriented TCP/IP protocol can also be used to transfer process commands from the host to the device. With this connection, the data is backed up by the TCP/IP protocol itself.

If you would like to use the TCP/IP protocol, you must also define whether the MA 208*i* is to operate as a TCP client or as a TCP server.

↳ *Contact your network administrator to determine which communication protocol is used.*

12.2.3 TCP/IP

↳ Set the TCP/IP mode of the MA 208*i*.

In **TCP client mode**, the MA 208*i* actively establishes the connection to the primary host system (PC / PLC as server). The MA 208*i* requires from the user the IP address of the server (host system) and the port number on which the server (host system) accepts a connection. In this case, the MA 208*i* determines when and with whom a connection is established!

↳ With a MA 208*i* as TCP client, set the following values:

- IP address of the TCP server (normally the PLC/host computer)
- Port number of the TCP server
- Optional: Timeout for the wait time for an answer from the server
- Optional: Repetition time for renewed communication attempt following a timeout

In **TCP server mode**, the primary host system (PC / PLC) actively establishes the connection and the connected MA 208*i* waits for the connection to be set up. The TCP/IP stack requires information from the user regarding the local port of the MA 208*i* (port number) on which the connection requests of a client application (host system) are to be accepted. If there is a connection request and a connection is established by the primary host system (PC / PLC as client), the MA 208*i* (server mode) accepts the connection. Data can then be sent and received.

↳ With a MA 208*i* as TCP server, also set the following values:

- Port number for the communication of the MA 208*i* with the TCP client

The corresponding adjustment options can be found in the configuration tool.

12.2.4 UDP

The MA 208*i* requires from the user the IP address and the port number of the communication partner. Correspondingly, the host system (PC / PLC) now also requires the set IP address of the MA 208*i* and the selected port number. By assigning these parameters, a socket is formed via which the data can be sent and received.

↳ Set the following values:

- IP address of the communication partner
- Port number of the communication partner

The corresponding adjustment options can be found in the configuration tool.

12.3 Setting the read parameters on the Leuze device

Commissioning the Leuze device

To commission a read station, you must prepare the Leuze device on the MA 208*i* for its reading task. Communication with the Leuze device occurs via the service interface.

**Notice!**

For further information on connecting and using the service interface, see chapter 9 "Configuration".

↳ To do this, connect the Leuze device to the MA 208*i*.

Depending on the Leuze device, this occurs either via a connection cable (accessory no.: KB 031-1000) or directly on the MA 208*i*. The service connector and corresponding switches can be accessed with the housing cover open.

↳ Select the "DEV" service switch position.

Connect the service interface; call up the terminal program

↳ Connect your PC to the service connector via the RS 232 cable.

↳ On the PC, call up a terminal program (e.g., BCL-Config) and check whether the interface (COM 1 or COM 2) to which you have connected the MA 208*i* is set to the following Leuze standard setting: 9600 baud, 8 data bits, no parity, 1 stop bit and STX, data, CR, LF.

You can download the config. tool from www.leuze.com -> Download -> Identify for BCL, RFID, VR etc.

In order to communicate with the connected Leuze device, the **STX, data, CR, LF** framing must be set on the PC terminal program, as the Leuze device is preconfigured ex works for this frame character.

STX (02h):	Prefix 1
CR (0Dh):	Postfix 1
LF (0Ah):	Postfix 2

Operation

↳ Switch the MA 208*i* to switch position "RUN" (operation).

The Leuze device is now connected to the fieldbus. Activation of the Leuze device can now occur via the switching input on the MA 208*i*, via the process data word Out bit 1 (bit 0.2) or by transmitting a "+" command to the Leuze device (see chapter 16 "Specifications for Leuze end devices"). For further information on the fieldbus transmission protocol, see chapter 10 "Telegram".

Reading out information in service mode

↳ Set the service switch of the gateway to switch position "MA" (gateway).

↳ Send a "v" command to call up all service information of the MA 208*i*.

An overview of the available commands and information can be found in chapter "Reading out information in Service mode" on page 40.

12.3.1 Specific feature for the use of hand-held scanners (bar code and 2D devices, combi devices with RFID)

**Notice!**

For a description of device configuration and the required codes, please see the corresponding documentation at www.leuze.com -> Download -> identify -> Bar code hand-held readers or 2D code hand-held readers.

12.3.1.1 Cable-connected hand-held scanners on the MA 208*i*

All hand-held scanners and mobile combi devices available in the Leuze electronic product line can be used with the corresponding connection cable.

When using the MA 208*i*, the voltage supply of the hand-held scanner (5V/at 1A) can be connected to the interface by means of a cable via the 9-pin Sub-D connector (voltage on PIN 9). The corresponding cable is to be selected for the respective hand-held scanner and ordered separately. The 9-pin Sub-D cable (KB JST-HS-300, Part No. 50113397) is connected to this cable, which is connected to the MA 208*i*. This cable must also be ordered separately.

In this example, triggering occurs by means of a trigger button on the hand-held scanner.

12.3.1.2 Wireless hand-held scanners on the MA 208*i*

All wireless hand-held scanners and mobile combi devices available in the Leuze electronic product line can be used with the corresponding connection cable via the base station.

A 230VAC connection (socket) is usually necessary for the charging station. Here, a data connection of the charging station is established with the MA 208*i*. The corresponding cable is to be selected for the respective hand-held scanner and ordered separately. The 9-pin Sub-D cable (KB JST-HS-300, part no. 50113397) is connected to this cable, which is connected to the MA 208*i*. This cable must also be ordered separately.

In this example, triggering occurs by means of a trigger button on the hand-held scanner.

The following codes for configuring the devices are necessary for these devices as well.

12.3.2 Specific features in the operation of an RFM/RFI

Shown here is a sample telegram for a write command in combination with an RFID device.



Notice!

Also note that all characters which are sent to a transponder are hex-encoded ASCII characters. Each of these (hexadecimal) characters is, in turn, to be handled as an individual ASCII character and converted to hexadecimal format for transmission via the fieldbus.

Example:

7	6	5	4	3	2	1	0	
00	00	00	00	00	00	00	00	Control byte 0
00	00	00	00	00	00	00	00	Control byte 1
34	35	31	31	30	35	30	57	Data
00	00	34	37	33	37	35	36	

HEX	57	30	35	30	31	31	35	34	36	35	37	33	37	34
CHAR	W	0	5	0	1	1	5	4	6	5	7	3	7	4
Plain text	T e s t													

13 Diagnostics and troubleshooting

If problems should occur during commissioning of the MA 208*i* you can refer to the following table. Typical errors and their possible causes are described here as well as tips for their elimination.

13.1 General causes of errors

Error	Possible error causes	Measures
Data loss (DL bit)	Data telegram longer than the bus telegram in bus cycle/memory size.	Increase in bus telegram length. Toggle out data earlier.
PWR status LED on the circuit board		
Off	No supply voltage connected to the device.	Check supply voltage.
	Hardware error.	Send the device to customer service.
Green/orange, flashing	Device in boot mode.	No valid firmware, send device to customer service.
Continuous orange light	Device error.	Send the device to customer service.
	Firmware update failed.	
COM LED on the housing (see figure 8.1 on page 34)		
Red continuous light	Configuration error.	Check interface.
PWR LED on the housing (see figure 8.1 on page 34)		
Off	No supply voltage connected to the device.	Check supply voltage.
Green, flashing	SERVICE active.	Service switch on RUN.
Red, flashing	Incorrect baud rate / address.	Check switch settings.
		Check baud rate or address.
Red continuous light	Device error.	Send the device to customer service.
LINK /RX/TX LEDs on the housing (see figure 8.1 on page 34)		
Off	No connection.	Check wiring/IP address.

Table 13.1: General causes of errors

13.2 Interface errors

Error	Possible error causes	Measures
No communication via Ethernet interface COM continuous red light LED	Incorrect wiring.	Check wiring.
	Different protocol settings.	Check protocol settings.
	Protocol not released.	Activate TCP/ IP or UDP.
Sporadic errors at the Ethernet interface	Incorrect wiring.	Check wiring. In particular, check wire shielding. Check the cable used.
	Effects due to EMC.	Check shielding (shield covering in place up to the clamping point). Check grounding concept and connection to functional earth (FE). Avoid EMC coupling caused by power cables laid parallel to device lines.
	Overall network expansion exceeded.	Check max. network expansion as a function of the max. cable lengths.

Figure 13.1: Interface error



Notice!

Please use **chapter 13 as a master copy** should servicing be required.

Cross the items in the "Measures" column which you have already examined, fill out the following address field and fax the pages together with your service contract to the fax number listed below.

Customer data (please complete)

Device type:	
Company:	
Contact partner / department:	
Phone (direct):	
Fax:	
Street / No:	
ZIP code/City:	
Country:	

Leuze Service fax number:

+49 7021 573 - 199

14 Type overview and accessories

14.1 Part number code

MA 2xx i

Interface	i =	Integrated fieldbus technology
	04	PROFIBUS DP
	08	Ethernet TCP/IP
	35	CANopen
	38	EtherCAT
	48	PROFINET RT
	55	DeviceNet
	58	EtherNet/IP
	MA	Modular interfacing unit

14.2 Type overview

Type designation	Description	Description
MA 204 <i>i</i>	PROFIBUS gateway	50112893
MA 208 <i>i</i>	Ethernet TCP/IP gateway	50112892
MA 235 <i>i</i>	CANopen gateway	50114154
MA 238 <i>i</i>	EtherCAT gateway	50114155
MA 248 <i>i</i>	PROFINET-IO RT gateway	50112891
MA 255 <i>i</i>	DeviceNet gateway	50114156
MA 258 <i>i</i>	EtherNet/IP gateway	50114157

Table 14.1: Type overview MA 2xx*i*

14.3 Accessory connectors

Type designation	Description	Description
KD 095-5A	M12 socket for voltage supply	50020501
KS 095-4A	M12 connector for SW IN/OUT	50040155
D-ET1	RJ45 connector for user-configuration	50108991
KDS ET M12 / RJ 45 W - 4P	Converter from M12 D-coded to RJ 45 socket	50109832

Table 14.2: Connectors for the MA 208*i*

14.4 Accessory ready-made cables for voltage supply

14.4.1 Contact assignment of PWR connection cable

PWR IN (5-pin socket, A-coded)			
<p>PWR IN SWIO_2 VIN 1 3 GND 4 FE SWIO_1 M12 socket (A-coded)</p>	Pin	Name	Core color
	1	VIN	brown
	2	SWIO_2	white
	3	GND	blue
	4	SWIO_1	black
	5	FE	gray
Thread	FE	bare	

PWR OUT (5-pin connector, A-coded)			
<p>PWR OUT SWIO_2 GND 3 1 VOUT 4 FE SWIO_1 M12 connector (A-coded)</p>	Pin	Name	Core color
	1	VOUT	brown
	2	SWIO_2	white
	3	GND	blue
	4	SWIO_1	black
	5	FE	gray
Thread	FE	bare	

14.4.2 Specifications of the cables for voltage supply

Operating temperature range	in rest state:	-30°C ... +70°C
	in motion:	5°C ... +70°C
Material	sheathing:	PVC
Bending radius		> 50mm

14.4.3 Order codes of the cables for voltage supply

Type designation	Description	Part no.
K-D M12A-5P-5m-PVC	M12 socket for PWR, axial plug outlet, open cable end, cable length 5 m	50104557
K-D M12A-5P-10m-PVC	M12 socket for PWR, axial plug outlet, open cable end, cable length 10 m	50104559

Table 14.3: PWR cables for the MA 208*i*

14.5 Accessory ready-made cables for bus connection

14.5.1 General information

- Cable KB ET... for connecting to Industrial Ethernet via M12 connector
- Standard cable available in lengths from 2 ... 30 m
- Special cables on request

14.5.2 Contact assignments of M12 Ethernet connection cable KB ET...

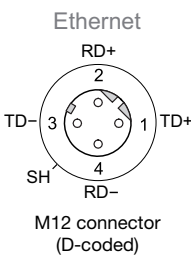
M12 Ethernet connection cable (4-pin connector, D-coded, on both sides)			
	Pin	Name	Core color
	1	TD+	yellow
	2	RD+	white
	3	TD-	orange
	4	RD-	blue
	SH (thread)	FE	bare

	Core color
	WH
	YE
	BU
	OG
Conductor class: VDE 0295, EN 60228, IEC 60228 (class 5)	

Figure 14.1: Cable structure of Industrial Ethernet connection cable

14.5.3 Technical data of M12 Ethernet connection cable KB ET...

Operating temperature range in rest state: -50°C ... +80°C
 in motion: -25°C ... +80°C
 in motion: -25°C ... +60°C (when used with drag chains)

Material cable sheath: PUR (green), wire insulation: PE foam,
 free of halogens, silicone and PVC

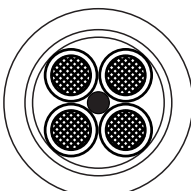
Bending radius > 65mm, suitable for drag chains

Bending cycles > 10⁶, perm. acceleration < 5m/s²

14.5.4 Order codes of M12 Ethernet connection cable KB ET...

Type designation	Description	Part no.
M12 connector for BUS IN, axial connector, open cable end		
KB ET - 1000 - SA	Cable length 1 m	50106738
KB ET - 2000 - SA	Cable length 2 m	50106739
KB ET - 5000 - SA	Cable length 5 m	50106740
KB ET - 10000 - SA	Cable length 10 m	50106741
M12 connector for BUS IN to RJ-45 connector		
KB ET - 1000 - SA-RJ45	Cable length 1 m	50109879
KB ET - 2000 - SA-RJ45	Cable length 2 m	50109880
KB ET - 5000 - SA-RJ45	Cable length 5 m	50109881
KB ET - 10000 - SA-RJ45	Cable length 10 m	50109882
M12 connector + M12 connector for BUS OUT to BUS IN		
KB ET - 1000 - SSA	Cable length 1 m	50106898
KB ET - 2000 - SSA	Cable length 2 m	50106899
KB ET - 5000 - SSA	Cable length 5 m	50106900
KB ET - 10000 - SSA	Cable length 10 m	50106901

Table 14.4: Bus connection cable for the MA 208*i*

14.6 Accessory ready-made cables for connecting Leuze Ident devices

14.6.1 Order codes for the device connection cables

Type designation	Description	Part no.
KB JST-3000	MA 31, BCL 90, IMRFU-1(RFU), cable length 3m	50115044
KB JST-HS-300	Hand-held scanner, cable length 0.3m	50113397
KB JST-M12A-5P-3000	BPS 8, BCL 8, cable length 3m	50113467
KB JST-M12A-8P-Y-3000	LSIS 4x2i, cable length 3m	50113468
KB JST-M12A-8P-3000	LSIS 122, cable length 3m	50111225
K-D M12A-5P-5m-PVC	Voltage supply, cable length 5m	50104557
K-D M12A-5P-10m-PVC	Voltage supply, cable length 10m	50104559
K-DS M12A-MA-5P-3m-S-PUR	ODS 96B with RS 232	50115049
K-DS M12A-MA-8P-3m-S-PUR	ODSL 30/D 232-M12	50115050
K-DS M12A-MA-5P-3m-1S-PUR	Konturflex Quattro RSX	50116791
KB AMS 1000 SA	AMS 200, cable length 1m	50106978
KB 500-3000-Y	BCL 300i, BCL 500i, cable length 3m	50110240
KB 031 1000	BCL 32, cable length 1m	50103621
KB 031 3000	BCL 32, cable length 3m	50035355

Table 14.5: Device connection cables for the MA 208*i*



Notice!

The BCL 22 devices with JST connector, RFM xx and RFI xx can be connected directly with the injection molded device cable.

14.6.2 Contact assignment for the device connection cables

K-D M12A-5P-5000/10000 connection cable (5-pin with injection molded connector), open cable end			
		Pin	Core color
	1	br/BN	brown
	2	ws/WH	white
	3	bl/BU	blue
	4	sw/BK	black
	5	gr/GY	gray

KB JST 3000 (RS 232 connection cable, JST pin strip 10-pin, open cable end)		
Signal	Core color	JST 10-pin
TxD 232	red	5
RxD 232	brown	4
GND	orange	9
FE	shield	10

15 Maintenance

15.1 General maintenance information

The MA 208*i* does not require any maintenance by the operator.

15.2 Repairs, servicing

Repairs to the device must only be carried out by the manufacturer.

 *Contact your Leuze distributor or service organization should repairs be required.
The addresses can be found on the inside of the cover and on the back.*



Notice!

When sending devices to Leuze electronic for repair, please provide an accurate description of the error.

15.3 Disassembling, packing, disposing

Repacking

For later reuse, the device is to be packed so that it is protected.



Notice!

Electrical scrap is a special waste product! Observe the locally applicable regulations regarding disposal of the product.

16 Specifications for Leuze end devices

Serial interface and Command mode

The corresponding Leuze end device can be selected while configuring the fieldbus gateway (see chapter 9 "Configuration").

The exact specifications for the individual Leuze end devices can be found in the following sections and in the device description.

The corresponding serial command is sent to the Leuze end device in Command mode. To send the corresponding command to the RS 232 device after activating the Command mode in byte 0 (control bit 0.0), set the corresponding bit in byte 2.

The Leuze end device also responds to most commands by sending data, such as the bar code contents, NoRead, device version, etc., back to the gateway. The answer is not evaluated by the gateway, but is instead passed on to the PLC.

For the BPS 8, AMS and hand-held scanners, a number of specific features are to be noted.

16.1 Standard setting, KONTURflex (S4 switch position 0)

This switch position can be used with almost all devices, since a data frame is transmitted along with it if necessary. A 00h in the data range of the control is interpreted as the end of a telegram/invalid, however.

The distance between two successive telegrams (without frame) must be more than 20ms in this switch position, since there is otherwise no clear separation between them. If necessary, the settings have to be adjusted on the device.

Leuze measuring sensors with RS 232 interface (such as a KONTURflex Quattro RS) do not necessarily use a telegram frame, which is why these are also operated in switch position 0.

Specifications for the serial interface

Default parameter	Standard
Baud rate	9600
Data mode	8N1
Handshake	no
Protocol	framing protocol without acknowledgment
Frame	<Data>
Data mode	transparent



Notice!

The data frame is specified via the switch position.

In the factory setting, the S4 switch position is 0. Resetting the settings to these is possible in S4 switch position F. The procedure for doing this is described in chapter 16.14.

KONTURflex specifications

Settings on the MA 208*i*

- Ethernet address is freely selectable
- Device selection switch at position "0"

Ethernet settings

- Setting the data length is not required.
- User parameters:
"Transparent mode", baud rate 38400, "4 data bits", "no parity", "2 stop bits"

KONTURflex settings

First, the following settings are to be performed on the device using KONTURFlex-Soft:

- Either "Autosend (fast)" or "Autosend with data in Modbus format"
- Repeat time "31.5ms"
- Autosend baud rate "38.4KB"
- 2 stop bits, no parity

16.2 Bar code reader BCL 8 (S4 switch position 1)

Specifications for the serial interface

Default parameter	BCL 8
Baud rate	9600
Data mode	8N1
Handshake	no
Protocol	framing protocol without acknowledgment
Frame	<STX> <Data> <CR> <LF>

Specifications for Command mode

To activate the Command mode, bit 0 must be set to 1 in control byte 0.

For further information, see chapter 11.1.2 "Command mode", figure 11.1.

Control bit	Meaning	Corresponds to serial command (ASCII)
0	Version query	v
1	Activation / deactivation reading gate	+ / -
2	Reference-code 1 teach-in	RT1
3	Reference-code 2 teach-in	RT2
4	Automatic configuration of reading task activation / deactivation	CA+ / CA-
5	Switching output 1 activation	OA1
6		
7	Switching output 1 deactivation	OD1
8	System standby	SOS
9	System active	SON
10	Query reflector polling	AR?
11	Output version of the boot kernel with check sum	VB
12	Output version of the decoder program with check sum	VK
13	Reset parameters to default values	PC20
14	Device restart	H

Recommended settings

Setting the data length is not required.

16.3 Bar code reader BCL 22 (S4 switch position 2)

Specifications for the serial interface

Default parameter	BCL 22
Baud rate	9600
Data mode	8N1
Handshake	no
Protocol	framing protocol without acknowledgment
Frame	<STX> <Data> <CR> <LF>

Specifications for Command mode

To activate the Command mode, bit 0 must be set to 1 in control byte 0.

For further information, see chapter 11.1.2 "Command mode", figure 11.1.

Control bit	Meaning	Corresponds to serial command (ASCII)
0	Version query	v
1	Activation / deactivation reading gate	+ / -
2	Reference-code 1 teach-in	RT1
3	Reference-code 2 teach-in	RT2
4	Automatic configuration of reading task activation / deactivation	CA+ / CA-
5	Switching output 1 activation	OA1
6	Switching output 2 activation	OA2
7	Switching output 1 deactivation	OD1
8	Switching output 2 deactivation	OD2
9		
10		
11	Output version of the boot kernel with check sum	VB
12	Output version of the decoder program with check sum	VK
13	Reset parameters to default values	PC20
14	Device restart	H
15		

Recommended settings

Setting the data length is not required.

16.4 Bar code reader BCL 32 (S4 switch position 3)

Specifications for the serial interface

Default parameter	BCL 32
Baud rate	9600
Data mode	8N1
Handshake	no
Protocol	framing protocol without acknowledgment
Frame	<STX> <Data> <CR> <LF>

Specifications for Command mode

To activate the Command mode, bit 0 must be set to 1 in control byte 0.

For further information, see chapter 11.1.2 "Command mode", figure 11.1.

Control bit	Meaning	Corresponds to serial command (ASCII)
0	Version query	v
1	Activation / deactivation reading gate	+ / -
2	Reference code teach-in activation / deactivation	, / .
3		
4	Automatic configuration of reading task activation / deactivation	CA+ / CA-
5	Switching output 1 activation	OA1
6	Switching output 2 activation	OA2
7	Switching output 1 deactivation	OD1
8	Switching output 2 deactivation	OD2
9		
10		
11		
12		
13		
14	Reset parameters to default values	PC20
15	Device restart	H

Recommended settings

Setting the data length is not required.

16.5 Bar code reader BCL 300i, BCL 500i (S4 switch position 4)

Specifications for the serial interface

Default parameter	BCL 300i, BCL 500i
Baud rate	9600
Data mode	8N1
Handshake	no
Protocol	framing protocol without acknowledgment
Frame	<STX> <Data> <CR> <LF>

Specifications for Command mode

To activate the Command mode, bit 0 must be set to 1 in control byte 0.

For further information, see chapter 11.1.2 "Command mode", figure 11.1.

Control bit	Meaning	Corresponds to serial command (ASCII)
0	Version query	v
1	Activation / deactivation reading gate	+ / -
2	Reference code teach-in activation / deactivation	RT+ / RT-
3		
4	Autom. configuration of reading task activation / deact.	CA+ / CA-
5	Switching output 1 activation	OA1
6	Switching output 2 activation	OA2
7	Switching output 1 deactivation	OD1
8	Switching output 2 deactivation	OD2
9		
10		
11		
12		
13	Parameter - difference to default parameter set	PD20
14	Reset parameters to default values	PC20
15	Device restart	H

Recommended settings

Setting the data length is not required.

16.6 Bar code reader BCL 90 (S4 switch position 5)

Specifications for the serial interface

Default parameter	BCL 90
Baud rate	9600
Data mode	8N1
Handshake	no
Protocol	framing protocol without acknowledgment
Frame	<STX> <Data> <CR> <LF>

Specifications for Command mode

To activate the Command mode, bit 0 must be set to 1 in control byte 0.

For further information, see chapter 11.1.2 "Command mode", figure 11.1.

Control bit	Meaning	Corresponds to serial command (ASCII)
0	Version query	v
1	Activation / deactivation reading gate	+ / -
2	Configuration mode	11
3	Alignment mode	12
4	Read operation	13
5		
6		
7		
8		
9		
10		
11		
12		
13		
14	Reset parameters to default values	PC20
15	Device restart	H

Recommended settings

Setting the data length is not required.

16.7 LSIS 122 (S4 switch position 6)

Specifications for the serial interface

Default parameter	LSIS 122
Baud rate	9600
Data mode	8N1
Handshake	no
Protocol	framing protocol without acknowledgment
Frame	<STX> <Data> <CR> <LF>

Specifications for Command mode

To activate the Command mode, bit 0 must be set to 1 in control byte 0.

For further information, see chapter 11.1.2 "Command mode", figure 11.1.

Control bit	Meaning	Corresponds to serial command (ASCII)
0	Version query	i
1	Activation/Deactivation of reading gate: 12h/14h	<DC2> / <DC4>
2		
3		
4		
5		
6		
7		
8		
9		
10		
11		
12		
13		
14		
15		

Recommended settings

Setting the data length is not required.

16.8 LSIS 4x2i (S4 switch position 7)

Specifications for the serial interface

Default parameter	LSIS 4x2i
Baud rate	9600
Data mode	8N1
Handshake	no
Protocol	framing protocol without acknowledgment
Frame	<STX> <Data> <CR> <LF>

Specifications for Command mode

To activate the Command mode, bit 0 must be set to 1 in control byte 0.

For further information, see chapter 11.1.2 "Command mode", figure 11.1.

Control bit	Meaning	Corresponds to serial command (ASCII)
0	Version query	v
1	Image acquisition trigger	+
2		
3		
4		
5		
6		
7		
8		
9		
10		
11		
12		
13		
14		
15		

Recommended settings

Setting the data length is not required.

16.9 Hand-held scanner (S4 switch position 8)

Specifications for the serial interface

Default parameter	Hand-held scanner
Baud rate	9600
Data mode	8N1
Handshake	no
Protocol	framing protocol without acknowledgment
Frame	<Data> <CR> <LF>



Notice!

Command mode cannot be used with hand-held scanners.

Recommended settings

Setting the data length is not required.

16.10 RFI, RFM, RFU RFID readers (S4 switch position 9)

Specifications for the serial interface

Default parameter	RFM 12,RFM 32 and RFM 62 RFI 32 RFU (via IMRFU)
Baud rate	9600
Data mode	8N1
Handshake	no
Protocol	framing protocol without acknowledgment
Frame	<STX> <Data> <CR> <LF>

Specifications for Command mode

To activate the Command mode, bit 0 must be set to 1 in control byte 0.
For further information, see chapter 11.1.2 "Command mode", figure 11.1.

Control bit	Meaning	Corresponds to serial command (ASCII)
0	Version query	v ¹⁾
1	Activation / deactivation reading gate	+ / -
2		
3		
4		
5		
6		
7		
8		
9		
10		
11		
12		
13		
14	Reset parameters to default values	R ¹⁾
15	Device restart	H

1) Not for IMRFU/RFU

Recommended settings

Setting the data length is not required.

The RFID devices expect the telegrams / data in HEX format.

16.11 BPS 8 bar code positioning system (S4 switch position A)

Specifications for the serial interface

Default parameter	BPS 8
Baud rate	57600
Data mode	8N1
Handshake	no
Protocol	binary protocol without acknowledgment
Frame	<Data>

Specifications for Command mode

To activate the Command mode, bit 0 must be set to 1 in control byte 0.

For further information, see chapter 11.1.2 "Command mode", figure 11.1.

Control bit	Meaning	Corresponds to serial command (HEX)	
		byte 1	byte 2
0	Request diagnostic info	01	01
1	Request marker info	02	02
2	Request SLEEP mode	04	04
3	Request position info	08	08
4	Request individual measurement	10	10
5			
6			
7			
8			
9			
10			
11			
12			
13			
14			
15			

Recommended settings

Setting the data length is not required.

In this switch position, the MA automatically sends a position request to the BPS 8 every 10ms until another command comes via the control. Automatic request only restarts when a new position request is sent by the PLC or when the MA is restarted.

16.12 AMS distance measurement device, ODSL xx optical distance sensors with RS 232 interface (S4 switch position B)



Notice!

In this switch position, 6-byte data (fixed) is always expected by the device. This is why a quick telegram sequence can be transmitted reliably even without a data frame.

AMS

Specifications for the serial interface

Default parameter	AMS
Baud rate	38400
Data mode	8N1
Handshake	no
Protocol	binary protocol without acknowledgment
Frame	<Data>

Specifications for Command mode

To activate the Command mode, bit 0 must be set to 1 in control byte 0.

For further information, see chapter 11.1.2 "Command mode", figure 11.1.

Control bit	Meaning	Corresponds to serial command (HEX)
0	Transmit individual position value = single shot	C0F131
1	Cyclically transmit position values	C0F232
2	Stop cyclical transmission	C0F333
3	Laser diode on	C0F434
4	Laser diode off	C0F535
5	Transmit single speed value	C0F636
6	Cyclically transmit speed values	C0F737
7		
8		
9		
10		
11		
12		
13		
14		
15		

Recommended settings

Setting the data length is not required.

ODSL 9, ODSL 30 and ODSL 96B



Notice!

The default settings of the ODS serial interface have to be adjusted! Further information on configuration of the interface can be found in the technical description of the corresponding device.

Specifications for the serial interface

Default parameter	AMS
Baud rate	38400
Data mode	8N1
Handshake	no
Protocol	ASCII transmission, 5-digit measurement value
Frame	<Data>

Specifications for Command mode

Command mode cannot be used with the ODSL 9, ODSL 30 and ODSL 96B.

The ODSL 9/96B is to be operated in the "Precision" measure mode. The mode is set through the display menu via `Application -> Measure mode -> Precision`. You can find more details on this in the technical description.

16.13 Modular interfacing unit MA 3x (S4 switch position C)

Specifications for the serial interface

Default parameter	MA 3x
Baud rate	9600
Data mode	8N1
Handshake	no
Protocol	framing protocol without acknowledgment
Frame	<STX> <Data> <CR> <LF>

Specifications for Command mode

To activate the Command mode, bit 0 must be set to 1 in control byte 0.
 For further information, see chapter 11.1.2 "Command mode", figure 11.1.

Control bit	Meaning	Corresponds to serial command (ASCII)
0	Version query	v
1		
2		
3		
4		
5		
6		
7		
8		
9		
10		
11		
12		
13		
14	Reset parameters to default values	PC20
15	Device restart	H

Recommended settings

Setting the data length is not required.



Notice!

In this switch position, the address of the multiNet slave is also transmitted in the first two bytes of the data range!

16.14 Resetting the parameters (S4 switch position F)

To reset all parameters of the MA that can be configured with software (such as baud rate, IP address, dependent on type) to the factory settings, do the following:

- ↳ *Set device switch S4 to F in a voltage free state.*
- ↳ *Switch the voltage on and wait until it is ready for operation.*
- ↳ *If necessary, switch the voltage off to prepare for commissioning.*
- ↳ *Set service switch S10 to the "RUN" position.*

17 Appendix

17.1 ASCII Table

HEX	DEC	CTRL	ABB	DESIGNATION	MEANING
00	0	^@	NUL	NULL	Zero
01	1	^A	SOH	START OF HEADING	Start of heading
02	2	^B	STX	START OF TEXT	Start of text characters
03	3	^C	ETX	END OF TEXT	Last character of text
04	4	^D	EOT	END OF TRANSMISSION	End of transmission
05	5	^E	ENQ	ENQUIRY	Request to transmit data
06	6	^F	ACK	ACKNOWLEDGE	Positive acknowledgment
07	7	^G	BEL	BELL	Bell signal
08	8	^H	BS	BACKSPACE	Backspace
09	9	^I	HT	HORIZONTAL TABULATOR	Horizontal tabulator
0A	10	^J	LF	LINE FEED	Line feed
0B	11	^K	VT	VERTICAL TABULATOR	Vertical tabulator
0C	12	^L	FF	FORM FEED	Form feed
0D	13	^M	CR	CARRIAGE RETURN	Carriage return
0E	14	^N	SO	SHIFT OUT	Shift out
0F	15	^O	SI	SHIFT IN	Shift in
10	16	^P	DLE	DATA LINK ESCAPE	Data link escape
11	17	^Q	DC1	DEVICE CONTROL 1 (X-ON)	Device control character 1
12	18	^R	DC2	DEVICE CONTROL 2 (TAPE)	Device control character 2
13	19	^S	DC3	DEVICE CONTROL 3 (X-OFF)	Device control character 3
14	20	^T	DC4	DEVICE CONTROL 4	Device control character 4
15	21	^U	NAK	NEGATIVE (/Tape) ACKNOWLEDGE	Negative acknowledge
16	22	^V	SYN	SYNCHRONOUS IDLE	Synchronization
17	23	^W	ETB	END OF TRANSMISSION BLOCK	End of data transmission block
18	24	^X	CAN	CANCEL	Invalid
19	25	^Y	EM	END OF MEDIUM	End of medium
1A	26	^Z	SUB	SUBSTITUTE	Substitution
1B	27	^[ESC	ESCAPE	Escape
1C	28	^\ ^]	FS GS	FILE SEPARATOR GROUP SEPARATOR	File separator Group separator
1D	29	^]	GS	GROUP SEPARATOR	Group separator
1E	30	^^	RS	RECORD SEPARATOR	Record separator
1F	31	^_ ^_	US US	UNIT SEPARATOR	Unit separator
20	32		SP	SPACE	Space
21	33		!	EXCLAMATION POINT	Exclamation point
22	34		"	QUOTATION MARK	Quotation mark
23	35		#	NUMBER SIGN	Number sign
24	36		\$	DOLLAR SIGN	Dollar sign
25	37		%	PERCENT SIGN	Percent sign
26	38		&	AMPERSAND	Ampersand
27	39		'	APOSTROPHE	Apostrophe
28	40		(OPENING PARENTHESIS	Opening parenthesis

HEX	DEC	CTRL	ABB	DESIGNATION	MEANING
29	41)	CLOSING PARENTHESIS	Closing parenthesis
2A	42		*	ASTERISK	Asterisk
2B	43		+	PLUS	Plus sign
2C	44		,	COMMA	Comma
2D	45		-	HYPHEN (MINUS)	Hyphen (minus)
2E	46		.	PERIOD (DECIMAL)	Period (decimal)
2F	47		/	SLANT	Slant
30	48		0		
31	49		1		
32	50		2		
33	51		3		
34	52		4		
35	53		5		
36	54		6		
37	55		7		
38	56		8		
39	57		9		
3A	58		:	COLON	Colon
3B	59		;	SEMICOLON	Semicolon
3C	60		<	LESS THAN	Less than
3D	61		=	EQUALS	Equals
3E	62		>	GREATER THAN	Greater than
3F	63		?	QUESTION MARK	Question mark
40	64		@	COMMERCIAL AT	Commercial AT
41	65		A		
42	66		B		
43	67		C		
44	68		D		
45	69		E		
46	70		F		
47	71		G		
48	72		H		
49	73		I		
4A	74		J		
4B	75		K		
4C	76		L		
4D	77		M		
4E	78		N		
4F	79		O		
50	80		P		
51	81		Q		
52	82		R		
53	83		S		
54	84		T		
55	85		U		
56	86		V		
57	87		W		
58	88		X		

HEX	DEC	CTRL	ABB	DESIGNATION	MEANING
59	89		Y		
5A	90		Z		
5B	91		[OPENING BRACKET	Opening bracket
5C	92		\	REVERSE SLANT	Reverse slant
5D	93]	CLOSING BRACKET	Closing bracket
5E	94		^	CIRCUMFLEX	Circumflex
5F	95		_	UNDERSCORE	Underscore
60	96		`	GRAVE ACCENT	Grave accent
61	97		a		
62	98		b		
63	99		c		
64	100		d		
65	101		e		
66	102		f		
67	103		g		
68	104		h		
69	105		i		
6A	106		j		
6B	107		k		
6C	108		l		
6D	109		m		
6E	110		n		
6F	111		o		
70	112		p		
71	113		q		
72	114		r		
73	115		s		
74	116		t		
75	117		u		
76	118		v		
77	119		w		
78	120		x		
79	121		y		
7A	122		z		
7B	123		{	OPENING BRACE	Opening brace
7C	124			VERTICAL LINE	Vertical line
7D	125		}	CLOSING BRACE	Closing brace
7E	126		~	TILDE	Tilde
7F	127		DEL	DELETE (RUBOUT)	Delete

A

Accessories	61
Bus connection cables	63
Cables for Leuze ident devices	65
Connector	61
Voltage supply cables	62
Areas of application for the fieldbus gateway	8
ASCII Table	83

C

Causes of errors	
General	59
Interface	60
Collective mode	15
Command mode	15, 50
Commissioning	52
Configuration	40, 52
Connecting the Leuze device	11
PCB connectors X30 ... X32	38
Connections	
PWR IN	27
PWR OUT switching input/output	29
Control bytes	47

D

Declaration of Conformity	5
Definition of terms	7
Description of functions	6
Device description	15
Device interface RS 232	31
Diagnosis	59
Dimensioned drawings	21
Disassembling	66
Disposing	66

E

Electrical connection	10
Connecting the Leuze device	11
Power supply and bus cable	11
Safety notices	26
Ethernet	
Cable lengths and shielding	33
Wiring	33
Ethernet connection cable	63

F

Fast commissioning	10
Fieldbus systems	18

I

Input byte 0	
Data loss	46
New data	46
Service mode active	46
Input byte 1	
Data length code	46
Intended use	8
Interface	
Ethernet TCP/IP	31

L

LED status indicators	34
Leuze device	
2D code reader	
LSIS 122	74
LSIS 4x2i	75
Bar code positioning system (BPS)	
BPS 8	78
Bar code reader (BCL)	
BCL 22	70
BCL 300i	72
BCL 32	71
BCL 500i	72
BCL 8	69
BCL 90	73
Distance measurement device	
AMS	79
Hand-held scanner	76
RFID read-write devices (RFM/RFI ...)	
RFM 12, 32 and 62	77
Setting the read parameters	55
Specific feature for hand-held scanners	57
Specifications for Command mode	67
Specifications for the serial interface	67

M

Maintenance	66
Mounting	
Device arrangement, selecting a mounting location	10, 25
Mounting the device	10, 24

O

Operating modes
 Operation17
 Service fieldbus gateway17
 Service Leuze device17
 Output byte 0
 Address bits 0 .. 448
 Broadcast48
 Command mode48
 New data48

P

Packing66

Q

Quality assurance5

R

Repair 8, 66

S

Safety notices 8
 Service interface 32, 38
 Service mode
 Commands41
 Information42
 Service switch38
 Servicing66
 Specifications20
 Electrical data20
 Environmental data21
 Indicators20
 Mechanical data20
 Starting the device 11, 53
 Status bytes45
 Structure of the fieldbus telegram44
 Symbols5

T

Telegram structure
 Input bytes45
 Output bytes47
 Transparent mode15
 Troubleshooting59
 Type overview 22, 61

W

Writing slave data 49