



**Model Number**

**RLK61-55-Z/31/135**

Retroreflective sensor with V95 quick disconnect

**Features**

- Cost-optimized series for standard tasks in a special design
- Compact design
- Wide range of mounting options thanks to cubic housing design with M30 thread
- 360° high visibility LEDs
- Programmable ON-delay, OFF-delay, and One-shot timers
- Version for universal voltages
- Relay output

**Product information**

The Series 61 sensor family is a comprehensive product line, offering five sensing modes. Each sensor is equipped with four LEDs that are highly visible from all directions, indicating Power-On, target presence and marginal excess gain. The widely recognized, polycarbonate housing provides a IP67 protection degree rating. Color-coded labels are clearly printed on the housing to easily identify the sensing mode. DC models offer a 4-in-1 output while AC/DC models have a SPDT relay output rated to 3 A. All versions come standard with an integral multifunction timer, sensitivity adjustment and Light-ON/Dark-ON switch. Series 61 sensors are cross-talk protected and have a high degree of resistance to ambient lighting. Each sensor can be mounted via front and rear slots, rear dovetail guide or M30 x 1.5 mounting base. Additionally, cabled sensor models provide 1/2" - 14 NPT internal threads for use with flexible conduit.

**Dimensions**

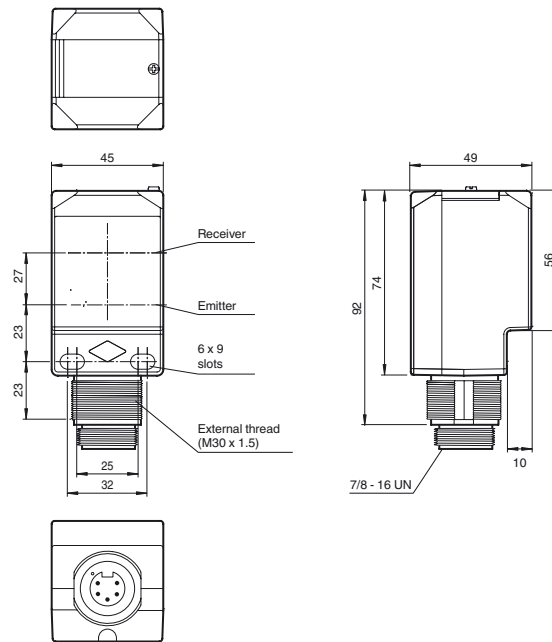

**Electrical connection**

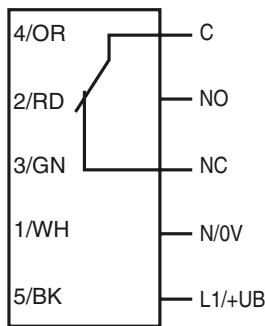

The relay-functions "NC" and "NO" bear on the switching mode "Dark-ON". This complies to the default setting of the light/dark switch (factory setting).

**Pinout**

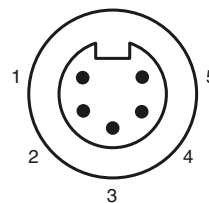

**Indicators/operating means**

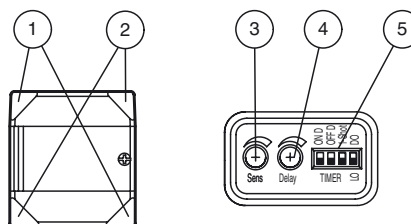

1	Operating display	green
2	Signal display	yellow
3	Sensing range adjuster	
4	Time adjuster	
5	DIP-switches	

Release date: 2013-01-04 18:12 Date of issue: 2013-01-04 911616\_eng.xml

Subject to modifications without notice

Pepperl+Fuchs Group  
www.pepperl-fuchs.com

USA: +1 330 486 0001  
fa-info@us.pepperl-fuchs.com

Germany: +49 621 776-4411  
fa-info@pepperl-fuchs.com

Copyright Pepperl+Fuchs  
Singapore: +65 6779 9091  
fa-info@sg.pepperl-fuchs.com

**Technical data****General specifications**

Effective detection range	0 ... 18 m
Reflector distance	0.3 ... 18 m
Threshold detection range	25 m
Reference target	FE-RR1 reflector
Light source	LED
Light type	modulated visible red light , 630 nm
Diameter of the light spot	approx. 350 mm at a distance of 18 m
Angle of divergence	1.1 °
Ambient light limit	5000 Lux ; according EN 60947-5-2

**Indicators/operating means**

Operating display	2 LEDs green
Function display	2 LEDs yellow on: reflector inside the sensing range off: reflector outside the sensing range
Controls	Light/Dark switch
Controls	Detection range adjuster
Controls	Time adjuster ( 0 ... 10 s )

**Electrical specifications**

Operating voltage	$U_B$	24 ... 240 V AC 12 ... 240 V DC
No-load supply current	$I_0$	≤ 35 mA
Protection class		II , rated voltage ≤ 250 V AC with pollution degree 1-2 according to IEC 60664-1 Output circuit basis insulation of input circuit according to EN 50178, rated insulation voltage 240 V AC
Power consumption	$P_0$	≤ 2 VA

**Output**

Switching type	light/dark on, switchable
Signal output	Relay, Form C
Switching voltage	max. 250 V AC/DC
Switching current	max. 3 A
Switching power	DC: max. 150 W AC: max. 750 VA
Switching frequency	$f$ 20 Hz
Response time	≤ 25 ms
Timer function	DIP-switch for selection of operating modes

**Ambient conditions**

Ambient temperature	-40 ... 55 °C (-40 ... 131 °F)
Storage temperature	-40 ... 70 °C (-40 ... 158 °F)

**Mechanical specifications**

Protection degree	IP67
Connection	5-pin V95 connector (7/8"-16 UN 2A)
Material	
Housing	PC (Polycarbonate)
Optical face	PMMA
Mass	130 g

**Compliance with standards and directives**

Standard conformity	
Product standard	EN 60947-5-2:2007 IEC 60947-5-2:2007

**Approvals and certificates**

UL approval	cULus
CCC approval	Certified by China Compulsory Certification (CCC)

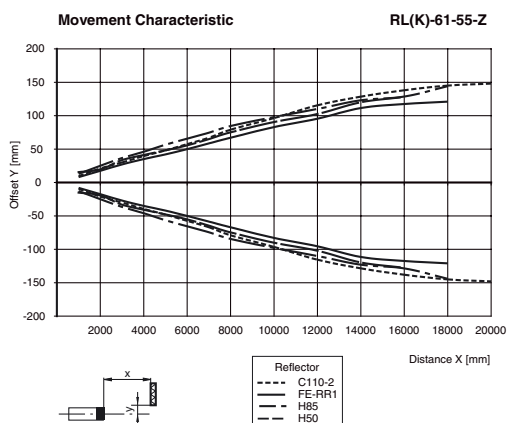
**Curves/Diagrams****Accessories****MPZB01**

Mounting bracket with vertical slots

**MPZB02**

Mounting bracket with circular slots

**MPZB06**

Ball and Swivel Mounting Bracket

**MPZB07**

Ball and Swivel Vertical Mounting Plate

**V95-G-YE2M-STOOW**

Female connector, 7/8" - 16 UNF, 5-pin, PVC cable

**V95-W-YE2M-STOOW**

Female connector, 7/8" - 16 UNF, 5-pin, PVC cable

Other suitable accessories can be found at [www.pepperl-fuchs.com](http://www.pepperl-fuchs.com)

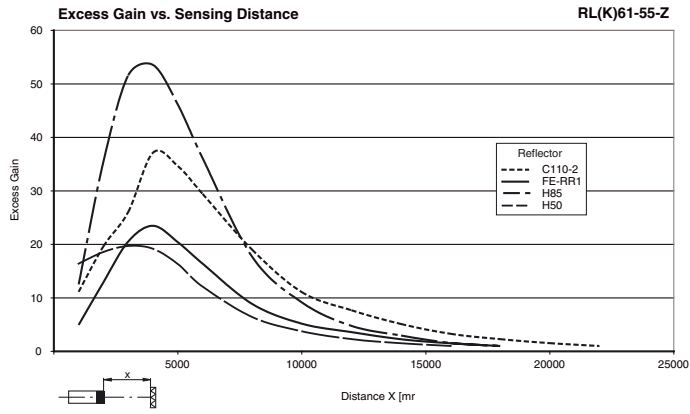

Release date: 2013-01-04 18:12 Date of issue: 2013-01-04 911616\_eng.xml

Timer Functions

Switching Type	Detection Status	Light Received
L.ON	Operation Mode	No Light Received
OFF ON  No Delay (Timer OFF)		ON
 ON Delay		OFF
 OFF Delay		ON
 One-Shot Delay		OFF
 ON Delay and OFF Delay		ON
		OFF
D.ON	Operation Mode	No Light Received
OFF ON  No Delay (Timer OFF)		ON
 ON Delay		OFF
 OFF Delay		ON
 One-Shot Delay		OFF
 ON Delay and OFF Delay		ON
		OFF

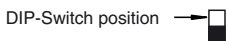

Time (T) is adjustable from 0 to 10 sec

Release date: 2013-01-04 18:12 Date of issue: 2013-01-04 911616\_eng.xml

## Adjustment Instructions

**Intended use:**

The retroreflective sensor contains the emitter and receiver in a single housing. The light from transmitter is reflected back from a reflector to the receiver. If an object interrupts the light beam, the switching function is initiated.

**Mounting instructions:**

The sensor can be mounted using the through-holes or with a mounting bracket (not included with delivery).

The base surface must be flat to avoid distorting the sensor housing during mounting. It is advisable to secure the bolts and screws with washers so that the sensor does not become misaligned.

**Adjustment Instructions:**

Connect the sensor to operating voltage and the green LED lights up solid.

Mount a suitable reflector opposite the sensor and make a rough adjustment.

The precise adjustment is done by swiveling the sensor horizontally and vertically. With optimum light reception, the yellow LED lights up solid. It will blink if the sensor requires fine adjustment.

**Object detection:**

Move an object into the light beam. If the object is detected, the yellow LED switches off. If it does not switch off, reduce the sensitivity with the potentiometer until it does. It should light up solid when the object is removed.

**Cleaning:**

The yellow LED flashes if the light received decreases (e.g. dirty lenses).

We recommend that you clean the optical interfaces and check all connections at regular intervals.