



Model Number

RL61-55-Z/92/127

Retroreflective sensor
with 4-pin, M12 x 1 connector

Features

- Cost-optimized series for standard tasks in a special design
- Compact design
- Wide range of mounting options thanks to cubic housing design with M30 thread
- 360° high visibility LEDs
- Programmable ON-delay, OFF-delay, and One-shot timers

Product information

The Series 61 sensor family is a comprehensive product line, offering five sensing modes. Each sensor is equipped with four LEDs that are highly visible from all directions, indicating Power-On, target presence and marginal excess gain. The widely recognized, polycarbonate housing provides a IP67 protection degree rating. Color-coded labels are clearly printed on the housing to easily identify the sensing mode. DC models offer a 4-in-1 output while AC/DC models have a SPDT relay output rated to 3 A. All versions come standard with an integral multifunction timer, sensitivity adjustment and Light-ON/Dark-ON switch. Series 61 sensors are cross-talk protected and have a high degree of resistance to ambient lighting. Each sensor can be mounted via front and rear slots, rear dovetail guide or M30 x 1.5 mounting base. Additionally, cabled sensor models provide 1/2" - 14 NPT internal threads for use with flexible conduit.

Dimensions

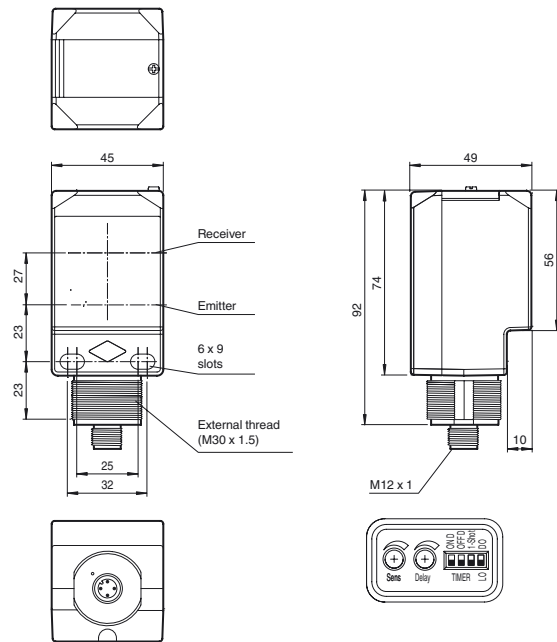

Electrical connection

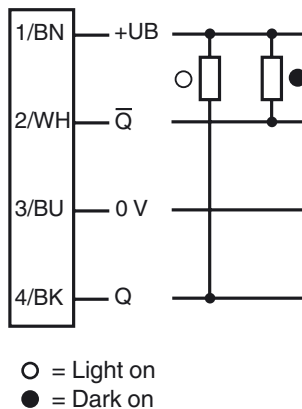

Pinout

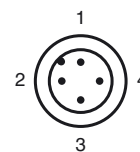

Indicators/operating means

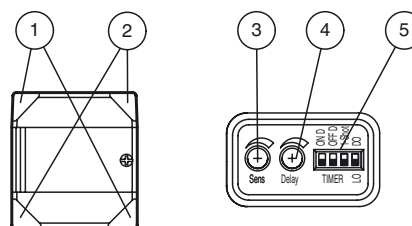

1	Operating display	green
2	Signal display	yellow
3	Sensing range adjuster	
4	Time adjuster	
5	DIP-switches	

Release date: 2013-01-04 18:12 Date of issue: 2013-01-04 913655_eng.xml

Subject to modifications without notice

Pepperl+Fuchs Group
www.pepperl-fuchs.com

USA: +1 330 486 0001
fa-info@us.pepperl-fuchs.com

Germany: +49 621 776-4411
fa-info@pepperl-fuchs.com

Copyright Pepperl+Fuchs
Singapore: +65 6779 9091
fa-info@sg.pepperl-fuchs.com

Technical data**General specifications**

Effective detection range	0 ... 18 m
Reflector distance	0.3 ... 18 m
Threshold detection range	25 m
Reference target	FE-RR1 reflector
Light source	LED
Light type	modulated visible red light , 630 nm
Diameter of the light spot	approx. 350 mm at a distance of 18 m
Angle of divergence	1.1 °
Ambient light limit	5000 Lux ; according EN 60947-5-2

Indicators/operating means

Operating display	2 LEDs green
Function display	2 LEDs yellow on: reflector inside the sensing range off: reflector outside the sensing range
Controls	Light/Dark switch
Controls	Detection range adjuster
Controls	Time adjuster (0 ... 50 ms)

Electrical specifications

Operating voltage	U_B	10 ... 30 V DC
Ripple		10 %
No-load supply current	I_0	≤ 35 mA
Protection class		II , rated voltage ≤ 250 V AC with pollution degree 1-2 according to IEC 60664-1 Output circuit basis insulation of input circuit according to EN 50178, rated insulation voltage 240 V AC

Output

Switching type	light/dark on, switchable	
Signal output	2 NPN complementary, short-circuit protected, reverse polarity protected	
Switching voltage	max. 30 V DC	
Switching current	max. 100 mA	
Voltage drop	U_d	≤ 2.5 V
Switching frequency	f	500 Hz
Response time		≤ 1 ms
Timer function		DIP-switch for selection of operating modes

Ambient conditions

Ambient temperature	-40 ... 55 °C (-40 ... 131 °F)
Storage temperature	-40 ... 70 °C (-40 ... 158 °F)

Mechanical specifications

Protection degree	IP67
Connection	connector M12 x 1, 4-pin
Material	
Housing	PC (Polycarbonate)
Optical face	PMMA
Mass	120 g

Compliance with standards and directives

Standard conformity	
Product standard	EN 60947-5-2:2007 IEC 60947-5-2:2007

Approvals and certificates

UL approval	cULus
CCC approval	Products with a maximum operating voltage of ≤36 V do not bear a CCC marking because they do not require approval.

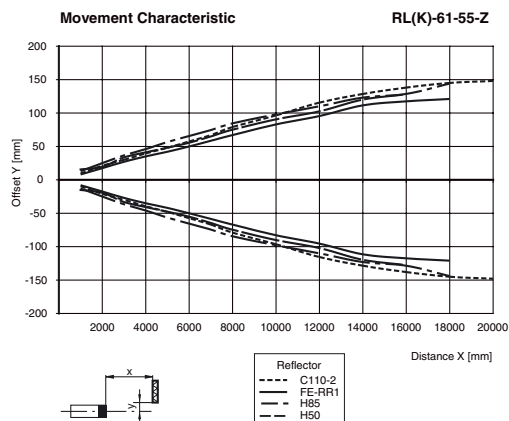
Curves/Diagrams**Accessories****MPZB01**

Mounting bracket with vertical slots

MPZB02

Mounting bracket with circular slots

MPZB06

Ball and Swivel Mounting Bracket

MPZB07

Ball and Swivel Vertical Mounting Plate

V1-G-2M-PUR

Cable socket, M12, 4-pin, PUR cable

V1-W-2M-PUR





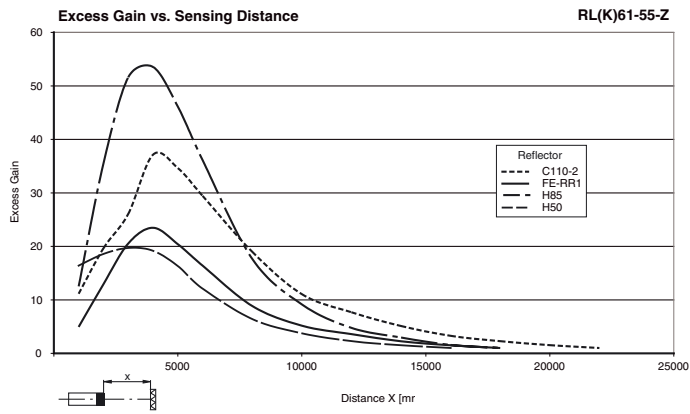





Cable socket, M12, 4-pin, PUR cable

Other suitable accessories can be found at www.pepperl-fuchs.com



Release date: 2013-01-04 18:12 Date of issue: 2013-01-04 913655_eng.xml

Timer Functions

Switching Type	Detection Status	Light Received
L.ON	Operation Mode	No Light Received
OFF ON  Timer LO	No Delay (Timer OFF)	ON OFF
OFF ON  Timer LO	ON Delay	ON OFF
OFF ON  Timer LO	OFF Delay	ON OFF
OFF ON  Timer LO	One-Shot Delay	ON OFF
OFF ON  Timer LO	ON Delay and OFF Delay	ON OFF
D.ON	Operation Mode	No Light Received
OFF ON  Timer LO	No Delay (Timer OFF)	ON OFF
OFF ON  Timer LO	ON Delay	ON OFF
OFF ON  Timer LO	OFF Delay	ON OFF
OFF ON  Timer LO	One-Shot Delay	ON OFF
OFF ON  Timer LO	ON Delay and OFF Delay	ON OFF

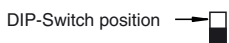

Time (T) is adjustable from 0 to 50 ms

Release date: 2013-01-04 18:12 Date of issue: 2013-01-04 913655_eng.xml

Adjustment Instructions

Intended use:

The retroreflective sensor contains the emitter and receiver in a single housing. The light from transmitter is reflected back from a reflector to the receiver. If an object interrupts the light beam, the switching function is initiated.

Mounting instructions:

The sensor can be mounted using the through-holes or with a mounting bracket (not included with delivery).

The base surface must be flat to avoid distorting the sensor housing during mounting. It is advisable to secure the bolts and screws with washers so that the sensor does not become misaligned.

Adjustment Instructions:

Connect the sensor to operating voltage and the green LED lights up solid.

Mount a suitable reflector opposite the sensor and make a rough adjustment.

The precise adjustment is done by swiveling the sensor horizontally and vertically. With optimum light reception, the yellow LED lights up solid. It will blink if the sensor requires fine adjustment.

Object detection:

Move an object into the light beam. If the object is detected, the yellow LED switches off. If it does not switch off, reduce the sensitivity with the potentiometer until it does. It should light up solid when the object is removed.

Cleaning:

The yellow LED flashes if the light received decreases (e.g. dirty lenses).

We recommend that you clean the optical interfaces and check all connections at regular intervals.